



## **Office Specialty**

Effective Date February, 2019

Contains Filing & Storage Products

**Contract # 07-57**

**Contract Period: April 1st, 2019 - March 31st, 2022**

**Current to supplement number: 0**

**Business size: Small**

For more information on ordering please contact our Government Team at [govteam@inscapesolutions.com](mailto:govteam@inscapesolutions.com)

On-line access to contract ordering information, terms and conditions, and up-to-date pricing at <https://myinscape.com/government>

Inscape Inc.

221 Lister Avenue

Falconer NY 14733

Telephone: 905 836-7676

Email: [GovTeam@inscapesolutions.com](mailto:GovTeam@inscapesolutions.com)

[www.inscapesolutions.com/products/government](http://www.inscapesolutions.com/products/government)

Office Specialty

# US Price List

February 2019





Conditions of sale	004	9900 Series Pedestals	025	Storage with Handles	137
Care & maintenance	005	<b>Freestanding, Letter Width</b>	<b>027</b>	<b>Pedestals</b>	<b>138</b>
General info	006	<b>Desk Height Application, Legal</b>	<b>033</b>	+ Freestanding, Letter Width	139
<b>Statement of line</b>	<b>006</b>	<b>Cushion Pedestals</b>	<b>034</b>	+ Cushion Pedestals	140
<b>Finishes &amp; optional fronts</b>	<b>007</b>	<b>Individually Locking Drawers</b>	<b>035</b>	<b>Laterals</b>	<b>141</b>
<b>Finishes</b>	<b>008</b>	9900 Series Laterals	037	<b>Workplace towers</b>	<b>145</b>
+ Surfaces & storage fronts	008	<b>Pre-configured</b>	<b>039</b>	Custom profile	147
+ Paint	009	+ 2 high	039	<b>Pedestals</b>	<b>148</b>
+ Upholstery	010	+ 3 high	041	<b>Laterals</b>	<b>151</b>
– Fabric collection	010	+ 4 high	042	+ Storage and Wardrobe Cabinets	156
+ Upholstery	012	+ 5 high	045	<b>Build-Ups</b>	<b>159</b>
– Fabric collection	012	+ 6 high	048	+ Basic Lateral Cabinets	159
<b>COM calculator &amp; fabric layup</b>	<b>015</b>	+ 7 high	052	+ Cabinet Interiors	162
<b>COM test</b>	<b>016</b>	+ 8 high	053	<b>Shop drawings</b>	<b>164</b>
<b>Panel height compatibility matrix</b>	<b>017</b>	+ Individually Locking	054	+ Drawer fronts for pedestals	164
<b>Media storage</b>	<b>018</b>	+ Secure Files	056	+ Drawer fronts for laterals	165
<b>Sliding rail quantities</b>	<b>019</b>	+ Lateral-Peds	057	+ Hinged drawers for multi-units	166
<b>Lock locations</b>	<b>020</b>	+ Multi-units	058	+ Doors for hinged door cabinets	167
<b>Counterweight matrix</b>	<b>023</b>	+ Mailroom Units with SuperStor™ Insert	061	GRID	171
<b>Case weights/cubes</b>	<b>024</b>	+ Overfile Sliding Door Cabinets	063	<b>Pedestals</b>	<b>172</b>
		+ Overfile and Storage Cabinets	064	<b>Laterals</b>	<b>174</b>
		+ Storage and Wardrobe Cabinets	065	<b>Storage Cabinets</b>	<b>177</b>
		+ Storage Cabinet with SuperStor™ Insert	072	+ Solid Core Doors	177
		+ Bookcase/File Combination Cabinets	073	+ Solid Core Doors	178
		<b>Build-ups</b>	<b>074</b>	+ Glazed Doors	180
		+ Basic Lateral Cabinets	075	<b>Multi-Units</b>	<b>182</b>
		+ Basic Lateral Cabinets with Security Lock Bar	078	+ Solid Core Doors	182
		+ Cabinet Interiors	079	+ Glazed Doors	185
		– Interior Drawers with Accessories	079	<b>Workplace towers</b>	<b>188</b>
		– Hinged Door Cabinet Inserts with Accessories	082	+ Wardrobes	189
		– Drawer and Shelf Interiors	083	+ Workplace Towers	191
		– SuperStor™ Inserts	091	+ Workplace Locker	193
		Towers	093	Accessories	195
		<b>Modular towers</b>	<b>094</b>	<b>For pedestals</b>	<b>197</b>
		+ Base Modules	095	<b>Interior Accessories for All Laterals</b>	<b>199</b>
		+ Base Modules with MoPed	097	<b>Interior Accessories for All Laterals/Hinged Door Units</b>	<b>202</b>
		+ Stack Modules	098	<b>For all laterals</b>	<b>203</b>
		+ Slimline Towers	099	<b>Lateral Tops</b>	<b>205</b>
		+ Monolithic Units	100	+ Plastic Laminate	205
		<b>Workplace towers &amp; lockers</b>	<b>111</b>	+ Nuform	206
		+ Wardrobes	112	+ Veneer	207
		+ Towers	116	<b>Lateral Cushions</b>	<b>208</b>
		+ Cubbi-Stor	119	<b>Glides</b>	<b>209</b>
		+ Cubbi-Stor	120	<b>Modular Towers</b>	<b>212</b>
		Bookcases & display cabinets	121	<b>Verticals</b>	<b>214</b>
		<b>Bookcases</b>	<b>122</b>		
		<b>Display Cabinets</b>	<b>129</b>		
		Specialty storage	131		
		<b>Verticals</b>	<b>132</b>		
		<b>Waste &amp; Recycle Bins</b>	<b>134</b>		
		<b>Fusion</b>	<b>136</b>		



# Conditions of sale

Refer to the [Conditions of Sale](#) document on [myinscape.com](http://myinscape.com).

## General information

The following information provides general guidelines for cleaning and maintaining all Office Specialty products including: Tackboards and Accessories.

## Painted metal filing and storage

- Clean painted metal surfaces with a soft damp cloth and warm soapy water.
- Paint touch up kits are available to repair minor scratches.
- Gently rub tougher grime away with a mild, non-abrasive household product such as “Vim” or “Windex”.
- Mechanical parts require no lubrication or maintenance.
- All parts are factory lubricated for a lifetime of superior performance.

## Worksurfaces and lateral tops

Nuform Solid and Nuform Woodgrain Surfaces: Nuform surfaces are manufactured by thermoforming a polymer sheet around an MDF substrate. The polymer sheet is surface-coated with a scratch resistant film.

- For general cleaning, use warm soapy water or a mild, non-abrasive household cleanser such as “Vim” or “Windex”.
- Tougher stains, such as ink, may be removed with methylhydrate.
- Do not use abrasive cleaners or highly solvent based chemicals such as gasoline, acetone or toluene.
- Do not place hot appliances directly on Nuform worksurfaces.
- Light scratches may be buffed from the foil surface by using a 400-600 grit wet sandpaper under light hand pressure in circular motions or by using a 3M Scotch Brite Pad (green color only) under light hand pressure in circular motions. **Note: Under no circumstances should power buffing tools be used.**
- Chips and deep scratches may be repaired by a professional touch-up service. Minor imperfections should be addressed immediately as neglect can result in more serious problems that could void the warranty.

## Plastic laminate surfaces

- High pressure plastic laminate is laminated to 1¼” thick particle board. Laminate surfaces include a color coordinated 2mm edge banding.
- For general cleaning, use warm soapy water or a mild, non-abrasive household cleanser such as “Vim” or “Windex”.
- An eraser may assist in removing ink marks.
- Do not use abrasive cleaners or bleaching cleaners.
- Although high pressure plastic laminates are resistant to scratching, avoid dragging sharp objects across the worksurface.
- Although laminates are heat resistant, a hot pad should be placed under appliances.

## Wood veneer surfaces

- Wood veneer surfaces are sealed and top coated with an open pore, catalyzed lacquer and are edged in ¼” thick, same species solid hardwood. Like all natural products, wood veneer worksurfaces may vary slightly in grain texture and color. For this reason, minor variations between pieces can be expected.
- Use a coaster for beverages.
- Dust worksurfaces with a dry cloth in the direction of the grain.
- For heavily soiled surfaces, use warm soapy water and a soft cloth.
- Do not use abrasive cleaning products.
- Although waxing and polishing is not necessary, waxing and polishing products may be applied if care is taken to avoid wax build-up which may cloud the finish.
- Blot spills up immediately.
- Exposure to strong sunlight should be avoided since fading may occur.
- Avoid dragging sharp objects across the surface.
- Avoid exposure to extreme heat, cold or humidity.
- Chips and scratches may be repaired by a professional touch-up service.

## Upholstered tackboards and cushions

- Vacuum or lightly brush fabrics to remove dirt build-up.
- Promptly remove stains by blotting, not rubbing the fabric to retain pile texture.
- Fabric may be cleaned with mild water-free solvents or water-based cleaning agents or foam.
- Always follow the manufacturer’s instructions and test clean a non-visible area first.

## Accessories

### Whiteboards

- Use only dry erase markers with whiteboards.
- Whiteboards are not intended for use with PERMANENT markers. Only Expo Markers are to be used on any Office Specialty Whiteboard.
- Whiteboards should be cleaned with Expo Eraser or a Microfiber cleaning cloth along with Expo Cleaning Solution which is formulated to remove residue from Expo Dry Erase Markers.

### Bin/shelf-mounted task light fixtures

- Include a 120v/60hz magnetic ballast. Replacements can be purchased from any electrical supply store.

## Proper loading of lateral cabinets

### To prevent tipping and possible injury...

1. Load cabinet starting at the bottom opening and work up. Reverse this procedure for unloading.
2. Wherever possible place heavier materials in the lower drawers.
3. Level the cabinet using the adjustable glides. Failure to level the cabinet correctly may result in cabinet malfunction.
4. Each cabinet is equipped with a patented Safelock™ interlock mechanism which prevents more than one drawer from being opened at a time. The interlock system must be kept in proper working order to ensure user safety.
5. Cabinets may be bolted together for additional stability. Counterweights may be required for cabinets that cannot be bolted together.

# General info

## Statement of line

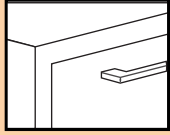
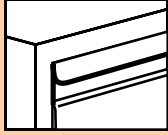
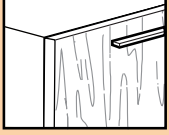
Series	Storage with Handles	9900 Series	GRID
<b>Pull detail</b>			

### Laterals

Pre-configured in 7 heights			
Build-up capability in 42 case heights			
3 drawer heights 3", 10½" & 12"			
3 drawer heights 6", 10½" & 12"			
8 drawer heights 3" to 16½" (not 4½" or 9")			
10 drawer heights 3" to 16½"			
Hinged door cabinets			

### Multi units

24" Hinged door insert			
27" & 39" Hinged door inserts			
Bookcase/file cabinets			
Acoustical files			
Secure files			
4 Designer fronts			
Custom impression patterns			
Glazed doors			

### Pedestals

Desk height, letter width			
Desk height, legal width			
Keyboard height, letter width			
Cushion pedestal, letter width			
Caddi-Stor			

### Verticals

Letter & legal width			
Vertical towers			

### Towers & lockers

Modular towers			
Workplace towers & lockers			

### Standard colors

All cabinets are finished with a two-coat electrostatic enamel that provides a high-quality, fade and chip resistant surface with a gloss level of 37.5%. Refer to our current Paint Card or Fans for standard color selection.

All interior drawer bodies, shelves, accessories and exposed hardware (excluding European style hinges and locks on the Storage with Handles and 9900 Series). Standard colors include a selection of mica/metallic colors available at no upcharge which is call the Neutral Collection. In addition Inscape offers the Accent Collection; a line of bright colors at an upcharge.

### Custom (non-standard) colors

Office Specialty offers colors matched to a customer's specification when possible. This matching is done through a database of over 3,000 existing color formulas or the development of a new custom color. A minimum order value of \$3,000 net per custom color applies to each order. A \$250 net fee applies for each custom color below this minimum. In addition, Custom Premium colors (bright whites and bright colors; textured paints; and reflection paints that use mica, aluminum or special chemical to create their reflective properties) will be subject to a 10% upcharge to the net value of the product.

### Multi-color cabinets

For multi-color cabinets where the case is one color and the drawer fronts are a second color, the following upcharge applies: Quantities of 15 or more units, add \$250 list per color. Quantities less than 15 units add \$500 list per color. (Tie bars and reference shelves will be painted the same color as the case.). If one of the colors is an accent paint, the standard accent paint upcharge per unit will need to be applied.

**Note: Multi-color cabinets are not available on Storage with Handles.**

### Paint finish availability matrix

	Standard colors	Textured colors	Custom (non-standard) colors
Storage with Handles	Available	Available	Available
9900 Series	Available	Available	Available
GRID	Available	Available	Available
Custom Profile Series	Available	Available	Available
Bookcase /Display Cabinets	Available	Available	Available

Available    Unavailable

### Lock finishes

Locks are available in Bright Chrome, Satin Chrome or Black finishes only. Specify a finish.

### Lock finish availability matrix

	Default	Optional	Optional
Storage with Handles	BC	BL	SC
9900 Series	BC	BL	SC
Custom Profile	BL	BC	SC
GRID - Wenge	BL	BC	SC
GRID - Cherry/Maple	SC	BL	BC
GRID - Woodgrain/Patterns	SC	BL	BC

<b>BL</b> Black	<b>BC</b> Bright Chrome	<b>SC</b> Satin Chrome
--------------------	----------------------------	---------------------------

### Custom profile

Custom Profile lateral, pedestal and hinged door cabinets are complete assembled units without fronts. Specifiers may design their own cabinet fronts using a variety of materials.

Refer to the Custom Profile section for a selection of basic cabinets and preconfigured cabinets. Detailed shop drawings depicting drawer and door fabrication specifications are included in the Custom Profile section.

**Office Specialty reserves the right to approve all requests for special finishes.**

# General info

## Finishes

### Surfaces & storage fronts

#### Nuform fronts & tops

Nuform is a thermo-formable polymer based sheet continuously bonded to a MDF substrate. The polymer sheet is surface coated with a scratch resistant film. Colors are homogenous throughout the film thickness. Top and edge are one continuous surface with no edge seams. The underside of the top is finished in a low pressure melamine.

#### Nuform Solid

Colorways	Product code
Warm White	F121
Mist	F122
Sandstone	F123
Frosty White	F127
Designer White	F129

#### Nuform Woodgrain

Colorways	Product code
Walnut	F06
Tannery Maple	F08
Honey Brown	F09
Musique Maple	F10
Jewel Cherry	F11
River Cherry	F16
Obsidian Oak	F34
Palos Mahogany	F35
Ash White	F37
Espresso	F38
Ash Espresso	F39
Swiss Elm	F40
Antique Whitewash	F41
Blonde Maple	F42
Barn Board	F43
Brazilian Nut	F44
Rustic Plank	F45

#### Laminate tops

Tops are self-edged, high pressure laminate with a backing sheet over a core of high density particle board. Tops are mounted onto cabinets using double sided tape which is included. The following laminates are available at no upcharge.

#### Laminate

Colorways	Product code
Wildcherry	OCC01
Maple	OCC02
White	OCC07
Pumice	OCC08
Antique White	OCC09
Gray	OCC12
Madagascar	OCC14
Asian Sand	OCC15
River Cherry	OCC16
Wenge	OCC17
Elegant White	OCC19
Neowalnut	OCC23
Mangalore Mango	OCC29
Pearwood	OCC30
Black	OCC33
Walnut Heights	OCC35
Studio Teak	OCC36
Slate Gray	OCC41
Raven	OCC42
Dalia	OCC43
Mimosa	OCC44
Inspiration	OCC45
Nova White	OCC46
Storm	OCC47
White Lace	OCC48
Chill	OCC49
Haze	OCC51
Dover White	OCC52
Graphite	OCC53

**OCC-18 is available but is reserved for existing customers due to its different edge banding.**

#### Grade 1 Laminate

Colorways	Product code
White Ash	O1C005
Weathered Ash	O1C006
Finnish Oak	O1C007
Fawn Cypress	O1C008

In addition, all Wilson Art with a "Matte - 60" finish, all Formica with a "Matte - 58" finish, all Nevamar with "Textured (T)" finish and all Pionite with "Suede (N)" finish are available as specials.

#### Composite veneer

Veneer thickness is 0.025". Overall thickness of the top is 1¼". The stain color is impregnated throughout the veneer for color consistency. The open pore veneer is clear coated with a catalyzed lacquer utilizing a multi-step process and has a gloss value of 45° when dry. Tops are constructed utilizing 45 lbs density particle board with an engineered balanced backer for structural integrity. Tops are edged in 3mm thick same species Veneer and do not have a pencil groove.

#### Composite Veneer

Colorways	Product code
Cherry	VC001
Maple	VC002
Wenge	VC003

#### Natural Veneer\*

Colorways	Product code
Natural Cherry	VN001
Standard Cherry	VN002
Natural Maple	VN003
Cape Coast Walnut	VN004
Natural Walnut	VN005

\*Natural Veneer finishes are not available on storage fronts.

**Note: Custom stains on veneers are available at an additional 20% upcharge and extra lead time. Due to the natural variations of wood products, Inscape can not guarantee the exact matching of color or grain patterns.**

### Paint Finishes

#### Neutral paint collection

Standard colors are prefixed with a 'P' and textured finishes are prefixed with a 'PT'.

Name	Color code	Textured colors
Bisque	004	
Chinook	010	
Onyx	013	
Frost	022	
Arctic	023	
Champagne	024	
Titanium	052	
Mushroom	055	
Krypton Reflections	063	
Cinder Reflections	066	
Soapstone	112	
Warm White	121	
Mist	122	
Sandstone	123	
Light Taupe	124	
Medium Gray	126	
Nickel Reflections	127	
Slate Reflections	128	
Quartz	160	
Glacier White	168	
Charcoal Gray	205	
Pebble Gray	217	
Deep White	223	
Mocha	255	
Latte	274	
Juniper Reflections	281	
Quicksilver Reflections	282	
Sunstone Reflections	284	
Aluminum Leaf	290	
Sasha	300	
Elson	301	
Shade	302	
Anonymous	303	
Urban	304	
Dorian	305	
Dover	306	
Jubilee	307	
Softer Tan	308	
Storm Cloud	309	
Rice Grain	310	
Ramie	311	
Favorite Tan	312	
High Tea	314	
Stone Reflections	315	
Dovetail Reflections	316	
Yorkshire	317	
Coriander	318	
Snowcap	319	
Salem	320	
Burnt Sierra	321	
Drizzle	322	
Scroll	323	
Cumin	324	
Seagull	325	
Smoke	326	
Gunpowder Blue	327	
Starlight Silver	329	
Martini Reflections	330	
Laminate White	332	

Name	Color code	Textured colors
Steel Wool	334	
Kettle Black	335	
White Velvet	336	
Simply White	337	
Dark Bronze **	338	

**\*\*Due to the semi-transparent nature of clear coat paint finish, the substrate material, as well as markings from the manufacturing process may be visible through the finish. For warranty information, please refer to the Inscape North American warranty on inscapesolutions.com**

#### Textured colors

Available	Unavailable

**Note: A 10% upcharge is applicable to the net value of the product for textured colors.**

#### Accent paint collection

Standard colors are prefixed with a 'A'.

Name	Color code
Peony	A339
Lilac	A340
Amethyst	A341
Mulberry	A342
Plum	A343
Citrine	A344
Canary	A345
Lotus	A346
Monarch	A347
Coral	A348
Amaryllis	A349
Apricot	A350
Cantaloupe	A351
Poppy	A352
Caliche	A353
Obsidian	A354
Dahlia	A355
Honeydew	A356
Sage	A357
Hummingbird	A358
Spring	A359
Marimo	A360
Fern	A361
Azure	A362
Wave	A363
Lapis Blue	A364
Atoll	A365
Papillon	A366
Lagoon	A367
Night Sky	A368
Aqua	A369
Inscape Teal	A370

# General info

## Finishes

Upholstery

Fabric collection

### Grade A

#### Open House

Pattern	Product code
Green Apple	U1400
Red Delicious	U1401
Onyx	U1402
Slate	U1403
Amber	U1404
Willow	U1405
Straw	U1406
Angora	U1407
Green Olive	U1412
Goose	U1413
Cumin	U1414
Deep Water	U1415
Quarry Blue	U1416
Midnight	U1417
Sunshine	U1419
Asteroid	U1421
Coffee Bean	U1425
Geranium	U1426
Thistle	U1427
Fossil	U1431
Lapis	U1432
Vanilla	U1434
Pumpkin	U1435
Wolf	U1436
Birch	UC2086
Eucalypt	UC2088
Graphite	UC2090
Cobalt	UC2091
Mulberry	UC2092
Pineneedle	UC2095
Aubergine	UC2096

#### Pebble

Pattern	Product code
Sindari	U1535
Nice	U1536
Waikiki	U1537
Siesta	U1538
South Beach	U1539
Schoolhouse	U1540
Mabua	U1541
Langkawi	U1542
Tenerife	U1543
Cape Cod	U1544
Maybay	U1545
Surfers Paradise	U1546
Negril	U1547
Papakolea	U1548
Chesil	U1549
Red Beach	U1550
Copacabana	U1551

#### Punch Card

Pattern	Product code
Alabaster	U2060
Carbon	U2061
Putty	U2062
Silver Lining	U2063
Crisp	U2064
Sky	U2065
Crimson	U2066
Orange	U2067
Navy	U2068
Cadet	U2069
Burgundy	U2070
Peat	U2071
Abyss	U2072

#### Vivid

Pattern	Product code
Soapstone	U4050
Mocha	U4051
Cocoa	U4052
Citrus	U4053
Chamois	U4054
Crimson	U4055
Holly	U4056
Ultramarine	U4057
Blue Jay	U4058
Quince	U4059
Parrot	U4060
Hunter	U4061
Mulberry	U4062
Grape	U4063
Blood Orange	U4064
Pumice	U4065
Concrete	U4066
Onyx	U4067

#### Quattro

Pattern	Product code
Chalk	U1889
Deep Crimson	U1890
Golden Orange	U1891
Granite	U1892
Hibiscus	U1893
Honeycomb	U1894
Khaki	U1895
Laguna	U1896
Leaf	U1897
Mallard	U1898
Mercury	U1899
Midnight Blue	U1900
Pumice	U1901
Skyway	U1902
Spring Green	U1903
Umber	U1904
Wheat	U1905
Onyx	U4067

#### Cross Check

Pattern	Product code
Biscuit	U1552
Blue Ribbon	U1553
Bottle	U1554
Dove	U1555
Evergreen	U1556
Imperial	U1557
Lime	U1558
Marine	U1559
Otter	U1560
Paradise	U1561
Peacock	U1562
Platinum	U1563
Plumberry	U1564
Red Baron	U1565
Slate Black	U1566
Stone	U1567
Sunshine	U1568
Taupe	U1569
Vermillion	U1570

#### Proverb

Pattern	Product code
Anchor	U1740
Armor	U1741
Basalt	U1742
Buff	U1743
Cinder	U1744
Crystal	U1745
Linen	U1746
Mist	U1747
Oyster	U1748
Rye	U1749
Steel	U1750
Storm	U1751

#### Glint

Pattern	Product code
Barley	U1658
Caspian	U1659
Column	U1660
Gobi	U1661
Gypsum	U1662
Note	U1663
Pearl	U1664
Pumice	U1665
Relic	U1666
Rune	U1667
Serene	U1668
Shale	U1669
Sisal	U1670
Turret	U1671
Vera	U1672



## Grade A Continued Script

Pattern	Product code
Almond	U1752
Charcoal	U1753
Feldspar	U1754
Flint	U1755
Nectar	U1756
Patina	U1757
Pebble	U1758
Sand	U1759
Shadow	U1760
Slate	U1761
Sterling	U1762
Taupe	U1763
Zinc	U1764

## Millennium

Pattern	Product code
Aglow	U1628
Amber	U1629
Anchor	U1630
Cascade	U1631
Cavern	U1632
Cerise	U1633
Clean	U1634
Coastal	U1635
Copper	U1636
Crisp	U1637
Electric	U1638
Geode	U1639
Lush	U1640
Mocha	U1641
Monument	U1642
Nector	U1643
Onyx	U1644
Orchid	U1645
Peridot	U1646
Plateau	U1647
Pool	U1648
Pyrite	U1649
Safari	U1650
Sapphire	U1651
Spark	U1652
Steel	U1653
Tanzanite	U1654
Thrill	U1655
Voyage	U1656
Zinc	U1657

## BeeHave

Pattern	Product code
Azure	U1825
Black	U1826
Carnelian	U1827
Clementine	U1828
Concord	U1829
Currant	U1830
Gris	U1831
Java	U1832
Lapis	U1833
Lemon	U1834
Pear	U1835
Pine	U1836
Plum	U1837
Slate	U1838

## Odyssey

Pattern	Product code
Alloy	U1765
Amp	U1766
Breeze	U1767
Captain	U1768
Carbon	U1769
Cedar	U1770
Craft	U1771
Cruise	U1772
Dijon	U1773
Eggplant	U1774
Emerald	U1775
Fossil	U1776
Ink	U1777
Inlet	U1778
Iris	U1779
Kiss	U1780
Linen	U1781
Lively	U1782
Maritime	U1783
Nettle	U1784
Oliver	U1785
Opaque	U1786
Primary	U1787
Roast	U1788
Rue	U1789
Sangria	U1790
Skim	U1791
Smith	U1792
Tinge	U1793
Western	U1794

## Tradition

Pattern	Product code
Ash	U1795
Branch	U1796
Class	U1797
Distant	U1798
Flirt	U1799
Fronde	U1800
Grain	U1801
Hedge	U1802
Hidden	U1803
Isle	U1804
Jazz	U1805
Kelly	U1806
Latte	U1807
Malbec	U1808
Miller	U1809
Mist	U1810
Peel	U1811
Plated	U1812
Regal	U1813
Sly	U1814
Soar	U1815
Soy	U1816
Spiced	U1817
Sprout	U1818
Sterling	U1819
Sun	U1820
Tango	U1821
Theater	U1822
Wash	U1823
Weld	U1824

## Cadence

Pattern	Product code
Citrine	U1863
Coral	U1864
Garnet	U1865
Jade	U1866
Jet	U1867
Lapis	U1868
Opal	U1869
Pearl	U1870
Peridot	U1871
Quartz	U1872
Ruby	U1873
Sapphire	U1874
Topaz	U1875
Turquoise	U1876

## Optic

Pattern	Product code
Ash	U1907
Brown Bear	U1908
Coal	U1909
Elephant	U1910
Fieldstone	U1911
Green Apple	U1912
Mulberry	U1913
Mushroom	U1914
Ocean	U1916
Red	U1917
Springtime	U1918
Sunrise	U1919
Tangerine	U1920
Yale	U1921

## Prism

Pattern	Product code
Alabaster	U1690
Asparagus	U1691
Café Au Lait	U1692
Caramel	U1693
Caribbean	U1694
Cerulean	U1695
Charcoal	U1696
Claret	U1697
Clay	U1698
Clementine	U1699
Cornflower	U1700
Dove	U1701
Espresso	U1702
Indigo	U1703
Kale	U1704
Lipstick	U1705
Mocha	U1706
Olive	U1707
Onyx	U1708
Plum	U1709
Raisin	U1710
Stone	U1711
Tomato	U1712
Topaz	U1713
Zinc	U1714

# General info

## Finishes

Upholstery

Fabric collection

### Grade A Continued

#### Intuition

Pattern	Product code
Admiral	U1849
Bisque	U1850
Charcoal	U1851
Coral	U1852
Hickory	U1853
Honey	U1854
Ochre	U1855
Peacock	U1856
Platinum	U1857
Sage	U1858
Sand	U1859
Scarlet	U1860
Slate	U1861
Viridian	U1862

#### Fedora

Pattern	Product code
Aegean	U1583
Aquamarine	U1584
Bitumen	U1585
Cactus	U1586
Charcoal	U1587
Citron	U1588
Dapper	U1589
Dew	U1590
Espresso	U1591
Eucalyptus	U1592
Fawn	U1593
Indigo	U1594
Light Grey	U1595
Midnight	U1596
Mink	U1597
Opal	U1598
Persimmon	U1599
Pewter	U1600
Plumberry	U1601
Purple	U1602
Ruby	U1603
Tangelo	U1604
Tomato	U1605
Topaz	U1606
Winter	U1607

#### Ranchero

Pattern	Product code
Basil	U1922
Black	U1923
Brandy	U1924
Chocolate	U1925
Driftwood	U1926
Ecu	U1927
Greige	U1928
Lipstick	U1929
Navy	U1930
Nickel	U1931
Sapphire	U1932
Sepia	U1933
Slate	U1934
Thunder	U1935

#### Florentino

Pattern	Product code
Bark	U1936
Basil	U1937
Biscuit	U1938
Bluejay	U1939
Caramel	U1940
Chili	U1941
Cream	U1942
Dijon	U1943
Dove	U1944
Fern	U1945
Jet	U1946
Jonquil	U1947
Khaki	U1948
Latte	U1949
Lipstick	U1950
Mango	U1951
Marine	U1952
Mocha	U1953
Mushroom	U1954
Plum	U1955
Sable	U1956
Sapphire	U1957
Scarlet	U1958
Sepia	U1959
Slate	U1960
Turquoise	U1961
Willow	U1962

#### Key Largo

Pattern	Product code
Aegean	U1968
Cayenne	U1969
Chocolate	U1970
Crimson	U1971
Ebony	U1972
Gold Coast	U1973
Graphite	U1974
Jonquil	U1975
Jungle	U1976
Khaki	U1977
Nassau	U1978
Palm	U1979
Parchment	U1980
Pear	U1981
Quarry	U1982
Raspberry	U1983
Sand	U1984
Sandstone	U1985
Tangerine	U1986
Toast	U1987
Ultramarine	U1988
Wheat	U1989

## Grade B

### Crossweave

Pattern	Product code
Flax	UW1101
Antelope	UW1102
Mountain	UW1103
Straw	UW1104
Cantaloupe	UW1105
Tangelo	UW1106
Shiraz	UW1107
Flower	UW1108
Alfalfa	UW1109
Parsley	UW1110
Freshwater	UW1111
Lake	UW1112
Atlantic	UW1113
Soapstone	UW1114
Penguin	UW1115
Seal	UW1116

### Hem Stitch

Pattern	Product code
Crème	UW2001
Antelope	UW2002
Husk	UW2003
Island	UW2005
Summer	UW2006
Dark Sky	UW2007
Chartreuse	UW2008
Leaf	UW2009
Tangerine	UW2010
Campfire	UW2011
Dove	UW2012
Walrus	UW2014

### Tweed Multi

Pattern	Product code
Taupe	UW1001
Tan	UW1002
Dark Taupe	UW1003
Yellow	UW1004
Pink	UW1005
Flame	UW1006
Medium Blue	UW1007
Turquoise	UW1008
Dark Blue	UW1009
Green	UW1010
Orange	UW1011
Light Grey	UW1012
Medium Grey	UW1013

### Quadrille

Pattern	Product code
Fair	UC1001
Cabaret	UC1002
Gambol	UC1003
Leisure	UC1004
Regalia	UC1005
Spring	UC1006
Zest	UC1007
Fiesta	UC1008
Carnival	UC1009
Spree	UC1010
Jubilee	UC1011
Opus	UC1012
Masquerade	UC1013
Soiree	UC1014
Revelry	UC1015
Escapade	UC1016
Shenanigan	UC1017

### Evoke

Pattern	Product code
Breeze	U1877
Cerise	U1878
Flax	U1879
Graphite	U1880
Grey Mist	U1881
Iris	U1882
Mahogany	U1883
Natural	U1884
Noir	U1885
Pacific	U1886
Pear	U1887
Terracotta	U1888

# General info

## Finishes

Upholstery

Fabric collection

### Grade C

#### Boucle Two-Tone

Pattern	Product code
Crème	UW3001
Mocha	UW3002
Dark Taupe	UW3003
Dark Brown	UW3004
Yellow	UW3005
Fuchsia	UW3006
Shiraz	UW3007
Lake	UW3008
Cornflower	UW3009
Sapphire	UW3010
Snap Pea	UW3011
Conifer	UW3012
Flame	UW3013
Storm	UW3014
Charcoal	UW3015

### Grade D

#### Tiny Herringbone

Pattern	Product code
Tan	UW4201
Brown	UW4202
Blue Green	UW4203
Blue	UW4204
Medium Grey	UW4205
Dark Charcoal	UW4206

Notes:

#### **COL (Customer Own Leather)**

COL is available and will be quoted on a per order basis.

#### **Contrasting topstitching**

White contrasting topstitching is available at no upcharge. Please specify at time of order placement.

#### **CAL 133**

There is a \$30 unit net upcharge for CAL 133 fire retardant rating on our mobile pedestal cushions. Contact your Client Services Representative for upcharge if required on lateral cushions.

**COM calculator**

Cushion Width	Cushion Depth	Cushion Thickness	Fabric Orientation	Back to Back Lateral	Fabric Quantity (run inches)
15"	18"	1.25"	Off the bolt		28
15"	22"	1.25"	Off the bolt		32
15"	28"	1.25"	Off the bolt		38
15"	18.75"	1.25"	Off the bolt		29
15"	22.75"	1.25"	Off the bolt		33
15"	28.75"	1.25"	Off the bolt		39
15"	36"	1.25"	Off the bolt	• (Planna Peds)	47
30"	18"	1.25"	Off the bolt		28
30"	36"	1.25"	Off the bolt	•	47
36"	18"	1.25"	Off the bolt		29
36"	36"	1.25"	Off the bolt	•	47
42"	18"	1.25"	Off the bolt		29
42"	36"	1.25"	Off the bolt	•	47
60"	18"	1.25"	Off the bolt		N/A
66"	18"	1.25"	Off the bolt		N/A
72"	18"	1.25"	Off the bolt		N/A
78"	18"	1.25"	Off the bolt		N/A
84"	18"	1.25"	Off the bolt		N/A
15"	18"	1.25"	Railroad		25
15"	22"	1.25"	Railroad		25
15"	28"	1.25"	Railroad		25
15"	18.75"	1.25"	Railroad		25
15"	22.75"	1.25"	Railroad		25
15"	28.75"	1.25"	Railroad		25
15"	36"	1.25"	Railroad		25
30"	18"	1.25"	Railroad		41
30"	36"	1.25"	Railroad	•	41
36"	18"	1.25"	Railroad		47
36"	36"	1.25"	Railroad	•	47
42"	18"	1.25"	Railroad		52
42"	36"	1.25"	Railroad	•	52
60"	18"	1.25"	Railroad		69
66"	18"	1.25"	Railroad		75
72"	18"	1.25"	Railroad		83
78"	18"	1.25"	Railroad		87
84"	18"	1.25"	Railroad		93

How to calculate COM yardage refer to 'COM fabric calculator'

**Input**

1. Select cushion width and depth appropriate to your specification
2. Select cushion thickness
3. Select fabric orientation (refer to 'Cushion Layup' sketches)
4. Find the corresponding fabric quantity in 'running inches' from the table

**Calculation**

1. Multiply the number of cushions required by the fabric quantity in 'running inches' off of the table
2. Divide the number of running inches by 36 to convert to yardage required. Round up to the nearest half yard.
3. If a pattern repeat is required, ordering a sample cushion is advised to determine fabric yardage and any applicable upcharges. A layup instruction will also be required for review.

**Example:**

- Storage with Handles Pedestal

- Quantity – 31 cushions

- 15" wide x 22" deep x 1.25" thick

- COM fabric is a solid colour and has no directional weave; best fabric usage is 'off the bolt' orientation.

**Note: Highlighted areas on the COM Calculator indicates 2 cushion yield per piece.**

**Calculation:**

32 running inches x 16 cushions = 512" of fabric required

512" divided by 36 = 14yds, 8"

**Total fabric required = 14 ½ yards (rounded up)**

**Additional Specification Information:**

1. Pedestal Cushion Depth options vary by product profile and application. Ensure you are referencing the correct dimensions
2. Lateral Cushion Depth options vary by application Ensure you are referencing the correct dimensions
3. Fabric Quantity is based on a 54" wide roll
4. Highlighted rows yield 2 cushions per fabric quantity listed
5. All directional/patterned fabrics (Graded or COM) require cushion layup instructions with order placement. Depending on layup additional fabric may be required and upcharges may apply. If layup instructions are not provided the layup that maximizes the production yield will be chosen. (Refer to the layup diagrams)
6. For any cushion sizes not listed on the COM Calculator or for further information please contact your Client Service Representative for assistance

**Fabric layup**

**Lateral cushion fabric layup**

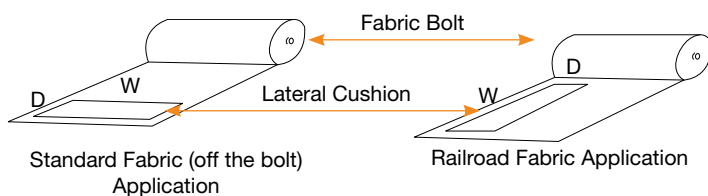

**Pedestal cushion fabric layup**

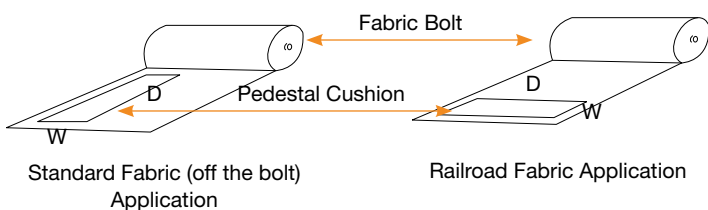

# General info

## COM test

You can download this form through InSite  
**Log in to InSite via the link below:**

[www.accessinsite.com](http://www.accessinsite.com)

Once in InSite the form can be found by searching

**Cushion COM Test Request**

**inscape**

## Cushion COM Test Request

Dealer		Contact		Phone Number		Cushion Style <input type="checkbox"/> 1.25" <input type="checkbox"/> 2"	
Fabric Manufacturer		Fabric Design		Color		Product Number	
Fabric Width	Fabric Content		Fabric Weight		CAL TB117 / ACT Flame Approved <input type="checkbox"/> Yes <input type="checkbox"/> No <small>Unapproved fabrics will not be processed by Inscape</small>		
<input type="checkbox"/> Yes <input type="checkbox"/> No	If yes, describe Upside	Repeating Pattern Req'd <input type="checkbox"/> Yes <input type="checkbox"/> No <small>If yes, production order must be Special</small>		Repeat Inches	Repeat Direction <input type="checkbox"/> Horizontal <input type="checkbox"/> Vertical		

### **Cushion COM Fabric Process Instructions and Information:**

1. Complete all fields above and send via email to [fabrictest@inscapesolutions.com](mailto:fabrictest@inscapesolutions.com) or fax to 877-870-0034.
2. Cushion Application testing requires 3 Memo Samples of the fabric described shipped prepaid to:  
**Inscape, 67 Toll Road, Holland Landing, ON, L9N 1H2. Attention: Fabric Testing.**
3. A list of previously approved Cushion fabrics can be viewed by clicking this link: <http://www.inscapeimages.com/pages>, or navigate to [www.inscapeimages.com](http://www.inscapeimages.com) and select "**COM Fabrics**" located along the top header.
4. Following test completion, a Cushion Application Test Results form will be issued indicating the test results.
5. For fabrics which have passed testing, a COM # will be assigned and provided on the results form. Use this COM # to identify subsequent deliveries of the tested fabric. Other colors of the same fabric line require separate COM #'s which can be obtained from your Client Services Representative.
6. In the event of a failure, remaining fabric greater than 5 yards will be returned at the customer's cost. Less than 5 yards will be disposed of without notification. We strongly discourage sending more than the required 1 yard until notification of a pass is received.
7. Application Testing provides assurance of upholsterability only, provided that the fabric is identical to the sample supplied for application testing. There are no other expressed or implied warranties.
8. INSCAPE assumes no responsibility for the physical characteristics of COM fabric such as color, colorfastness, fabric defects, durability or performance.

Office Specialty lateral files are manufactured in 1½” increments and available in 42 case heights ranging in size from 18” to 80”, making it possible to match virtually any panel height. The Panel Height Compatibility Matrix shows Office Specialty’s case heights against the most commonly used panel heights.

Panel height compatibility matrix

**Office Specialty’s case heights**











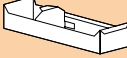

Panel heights	Lateral files	Workplace lockers & towers	Modular towers
30”	29 7/8”		
33”	32 7/8”		
34”	32 7/8”		
36”	35 7/8”		
38”	37 3/8”		36 1/4”
39”	38 7/8”		
40”	38 7/8”		
42”	41 7/8”		
45”	44 7/8”	43 3/8”	
47”	46 3/8”		46 3/4”
48”	47 7/8”		
49”	47 7/8”		48 1/4”
50”	49 3/8”		49 3/4”
51”	50 7/8”		
53”	52 3/8”		
54”	53 7/8”		
56”	55 3/8”		
62”	61 3/8”	61 3/8”	61 3/4”
63”	62 7/8”	62 7/8”	
64”	62 7/8”		63 1/4”
66”	65 7/8”		
67”	65 7/8”		
68”	67 3/8”		
70”	68 7/8”		



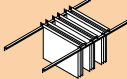





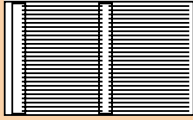
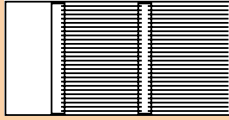

# General info

## Media storage

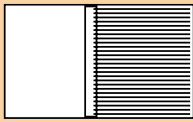
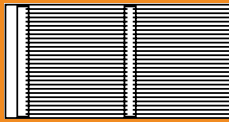
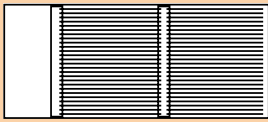
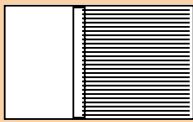
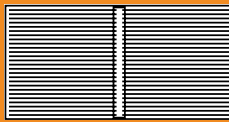
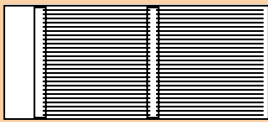
Drawer size and the typical media stored

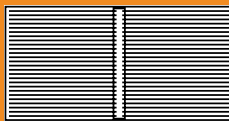
		Drawer size												
		Fixed front drawers						Lift-up doors						
		3"	6"	7.5"	9"	10.5"	12"	13.5"	15"	16.5"	12"	13.5"	15"	16.5"
	Pencils, pens, business cards, paper clips...	Yes												
	Index cards, microfiche, microfilm, envelopes, 3½" diskettes, hard disk cartridge, videotapes...		Yes											
	5¼" diskettes, HP rewritable optical disk (CD ROM), audio tapes, and CD's...			Yes										
	Special applications, oversized items...				Yes									
	Top tab folders (suspended) 8½" x 11" letter, 8½" x 14" legal, 8½" x 14⅞" EDP					Yes	Yes							
	Top tab folders (non-suspended) 8½" x 11" letter, 8½" x 14" legal, 8½" x 14⅞" EDP					Yes	Yes				Yes			
	EDP accodata binders and non-suspended tape seals, books, manuals...							Yes	Yes					
	X-Rays, Oversized EDP Printouts and European Binders...									Yes				
	End tab folders (non-suspended), 7", 8½" tape seals, 8½" x 14⅞" suspended binders...										Yes			
	Binder storage - 11¼"H, 10½" tape seals, 8½" x 14⅞" suspended binders...											Yes		
	Binder storage - 13¼"H, 10½" tape seals, 11" x 14⅞" suspended binders...												Yes	
	European binder - 14¼"H, office equipment (ie. copier, etc.)...													Yes

For front-to-back filing

Type of Filing	30" Wide	36" Wide	42" Wide
<b>Letter size</b>	 2-SR (30")	 2-SR (30")	 2-SR (45")
<b>Legal size</b>	 1-SR (15")	 2-SR (30")	 2-SR (30")
<b>14 7/8" x 11" EDP</b>	 1-SR (15")	 1-SR (30")	 2-SR (30")
<b>14 7/8" x 8 1/2" EDP</b>	 1-SR (15")	 1-SR (30")	 2-SR (30")
<b>8 1/2" x 11" EDP</b>	 2-SR (30")	 3-SR (45")	 3-SR (45")

**Highest efficiency**

# General info

## Lock locations

For all product lines except modular towers & GRID

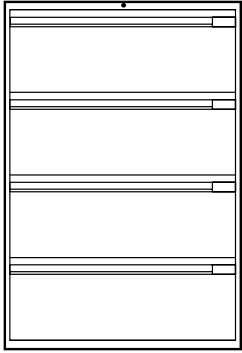

Laterals

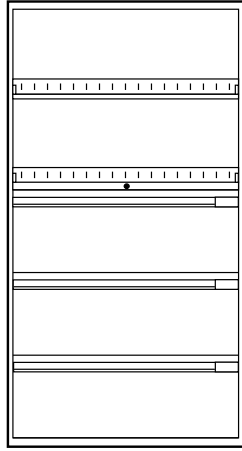

Bookcase/file

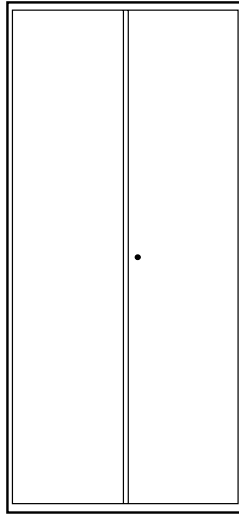

Hinged doors

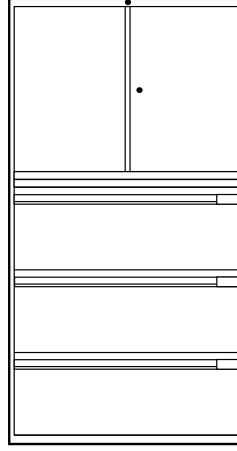

Multi-units

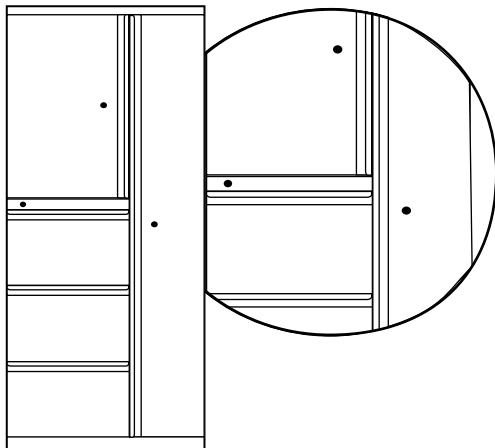

Workplace towers

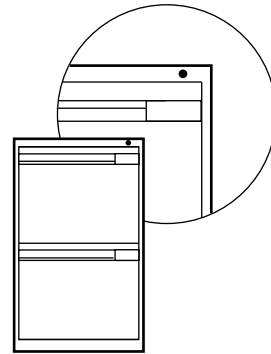

Pedestals

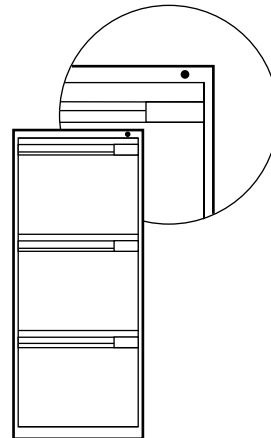

Verticals

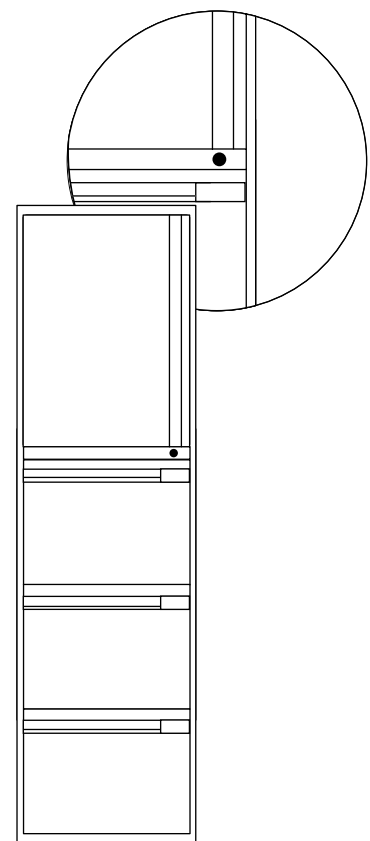

Vertical towers

Modular towers

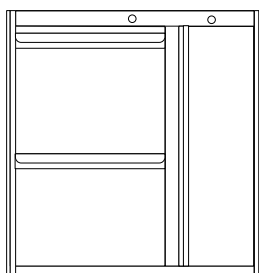
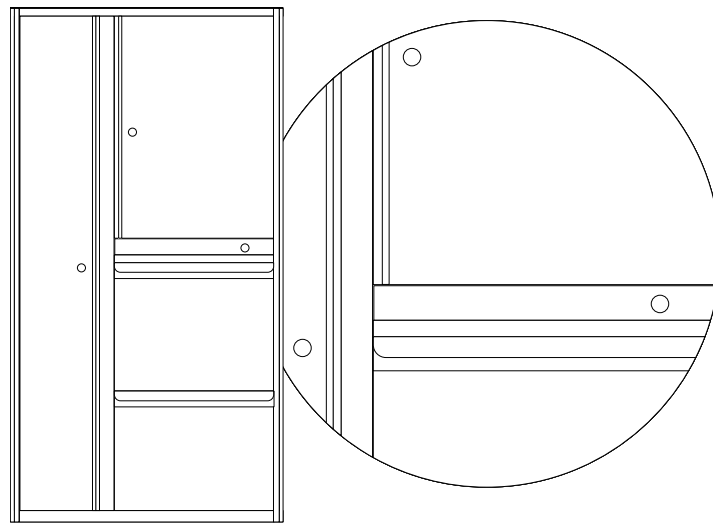
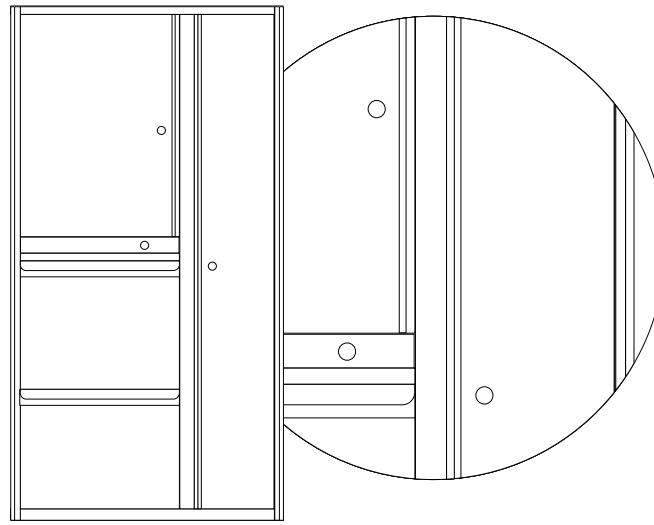

With MoPed

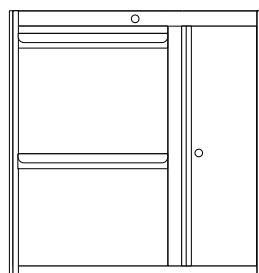

With Hinged Door

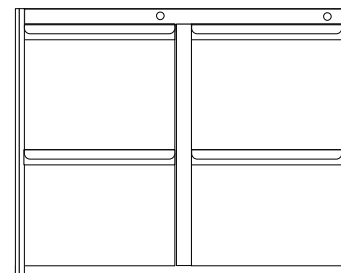

Double Pedestal Base Module

# General info

## Lock locations

### GRID

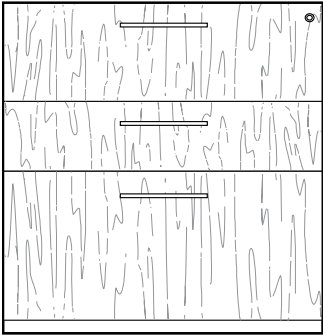

Laterals

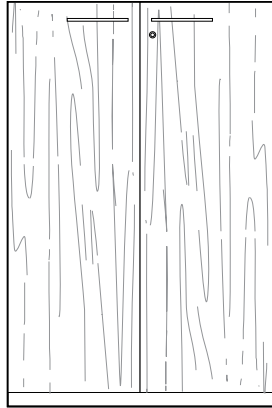

Hinged doors  
- 24" interior height

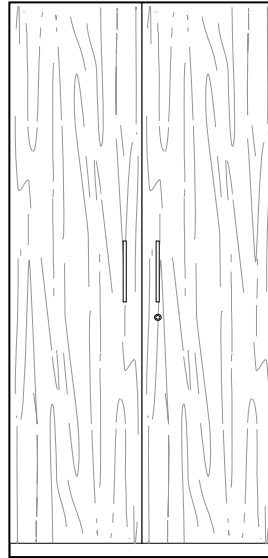

Hinged doors  
- all except 24" interior height

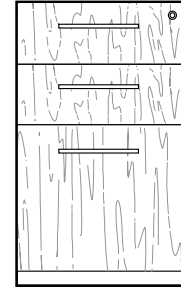

Pedestals

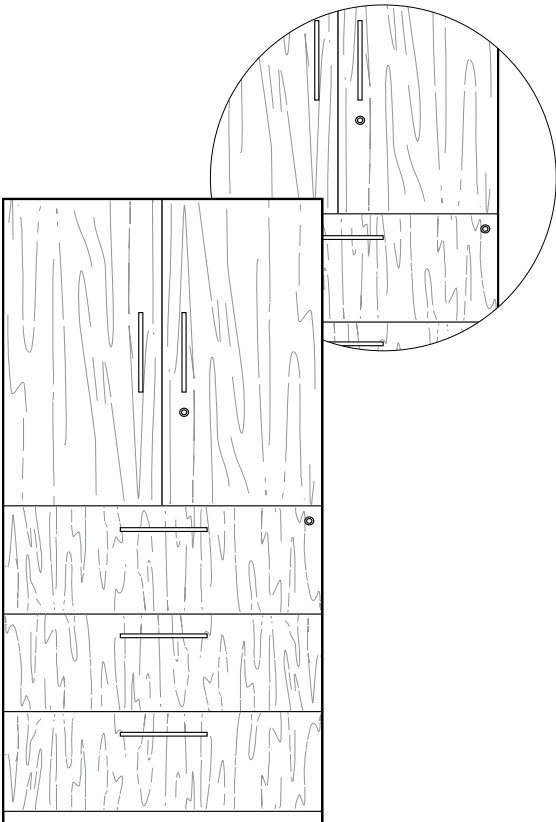

Multi-units

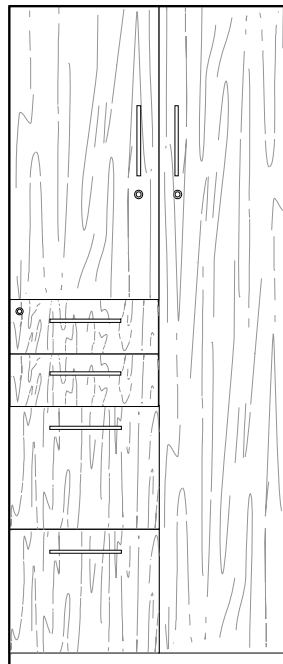

Towers  
- Right hand hinged door



Towers  
- Left hand hinged door

Counterweight matrix

Product	Can counterweight be ordered during lateral cabinet order entry?	Can Counterweight be installed in factory?	Field installed counterweight order entry code*
30"W Laterals - 21"I.D. & lower	YES	NO	CW
36"W Laterals - 21"I.D. & lower	YES	NO	CW
42"W Laterals - 21"I.D. & lower	YES	NO	CW
30"W Laterals - 22.5"I.D. & higher	YES	NO	IMCW-30
36"W Laterals - 22.5"I.D. & higher	YES	NO	IMCW-36
42"W Laterals - 22.5"I.D. & higher	YES	NO	IMCW-42
Split unit laterals (Storwal)	NO	NO	N/A
Lat/ped combo laterals	NO always included	YES	PFCW
Glide pedestals/verticals	YES	YES	WS-CW
Mobile pedestals (except Storage with Handles series)	NO always included	NO	PM-CW
Storage with Handles Mobile Pedestals	NO always included	NO	PM-CW79
Waste/Recycle Verticals	YES	NO	PFCW3
Workplace towers & lockers	NO	NO	N/A
Modular towers (except double pedestal)	NO	NO	N/A
Double-pedestal modular towers	NO always included	NO	CW
All non-standard (special) laterals, pedestals, etc.	To be advised by Engineering Specials Department		

\*Notes:

Innviromass™ counterweight plates are be field installed into lateral file cabinets by inserting a 30", 36" or 42" wide retaining wire into holes in the left and right hand rear strips. To accommodate these wires, the .141" diameter holes in rear strips have been changed to .148" diameter.

Innviromass™ counterweight plates are to be field installed into Mobile pedestals (except Storage with Handles) using one security bracket and two strips of double-coated tape for each counterweight plate. The security bracket and double-coated tape is supplied with the counterweight, but must be applied to the counterweight in the field per the Counterweight Installation Instruction sheet.

The Innviromass™ counterweights for field installation 'IMCW-30, IMCW-36 & IMCW-42' consist of one Innviromass plate and one retaining wire.

- The 'CW' counterweight for field installation consists of two 24LB steel plates
- The 'WS-CW' counterweight for field installation consists of one 16LB steel plate
- The 'PM-CW' counterweight for field installation consists of one 24LB Innviromass™ plate, one security bracket and two strips of double-coated tape.
- The 'PM-CW79' counterweight for field installation consists of one 24LB steel plate
- The 'PFCW' counterweight for field installation consists of two 16LB steel plates
- The 'PFCW3' counterweight for field installation consists of three 16LB steel plates

Any non-standard (special) lateral file cabinet, pedestals, vertical etc. for which there is a requirement for counterweights must be reviewed by the Engineering specials department before the order is released to Production. This applies to new product requests AND product that has been ordered in the past.

At this time, counterweights for Workplace lockers, Workplace towers and Modular Towers (except double-pedestal Modular Tower) are not available. Any requests for these products with a counterweight must be routed to the Engineering Specials Department.

# General info

## Case weights/cubes

### Case weights/cubes

Exterior height	30" Wide				36" Wide				42" Wide			
	Weights		Cubes		Weights		Cubes		Weights		Cubes	
	lbs	(kg)	ft	(m)	lbs	(kg)	ft	(m)	lbs	(kg)	ft	(m)
17 5/8"	25	(11.3)	8	(.22)	31	(14)	10	(.28)	36	(16.3)	11	(.31)
19 3/8"	27	(12.2)	9	(.25)	34	(15.4)	10	(.28)	40	(18)	12	(.34)
20 7/8"	30	(13.6)	10	(.28)	38	(17.2)	11	(.31)	44	(19.9)	13	(.37)
22 5/8"	33	(14.9)	10	(.28)	41	(18.6)	12	(.34)	48	(21.7)	14	(.40)
23 7/8"	36	(16.3)	11	(.31)	44	(19.9)	13	(.37)	52	(23.5)	15	(.42)
25 5/8"	37	(16.7)	11	(.31)	45	(20)	13	(.37)	53	(24)	15	(.42)
26 7/8"	38	(17.2)	12	(.34)	46	(21)	14	(.40)	54	(24.5)	16	(.45)
28 5/8"	39	(17.6)	13	(.37)	47	(21.3)	15	(.42)	55	(24.9)	17	(.48)
29 7/8"	41	(18.6)	14	(.40)	49	(22.2)	16	(.45)	57	(25.8)	18	(.51)
31 5/8"	42	(19)	14	(.40)	50	(22.6)	16	(.45)	59	(26.7)	19	(.54)
32 7/8"	43	(19.5)	14	(.40)	52	(23.5)	17	(.48)	61	(27.6)	20	(.56)
34 5/8"	44	(19.9)	15	(.42)	53	(24)	18	(.51)	62	(28.1)	20	(.56)
35 7/8"	45	(20)	16	(.45)	54	(24.5)	18	(.51)	63	(28.5)	21	(.59)
37 5/8"	47	(21.3)	16	(.45)	56	(25.4)	19	(.54)	65	(29.4)	22	(.62)
38 7/8"	48	(21.7)	17	(.48)	58	(26.3)	20	(.56)	68	(30.8)	23	(.65)
40 5/8"	49	(22.2)	17	(.48)	59	(26.7)	20	(.56)	70	(31.7)	24	(.68)
41 7/8"	50	(22.6)	18	(.51)	60	(27.2)	21	(.59)	72	(32.6)	25	(.71)
43 5/8"	51	(23.1)	18	(.51)	62	(28.1)	22	(.62)	74	(33.5)	25	(.71)
44 7/8"	52	(23.5)	19	(.54)	64	(29)	23	(.65)	76	(34.4)	26	(.74)
46 5/8"	54	(24.5)	20	(.56)	66	(29.9)	23	(.65)	78	(35.3)	27	(.76)
47 7/8"	56	(25.4)	21	(.59)	68	(30.8)	24	(.68)	80	(36.2)	28	(.79)
49 5/8"	57	(25.8)	21	(.59)	69	(31.2)	25	(.71)	81	(36.7)	28	(.79)
50 7/8"	58	(26.3)	22	(.62)	70	(31.7)	26	(.74)	82	(37)	30	(.85)
52 5/8"	59	(26.7)	22	(.62)	71	(32.2)	26	(.74)	83	(37.6)	30	(.85)
53 7/8"	60	(27.2)	23	(.65)	72	(32.6)	27	(.76)	84	(38)	31	(.88)
55 5/8"	61	(27.6)	23	(.65)	73	(33)	27	(.76)	85	(38.5)	32	(.91)
56 7/8"	62	(28.1)	24	(.68)	74	(33.5)	28	(.79)	86	(39)	33	(.93)
58 5/8"	64	(29)	24	(.68)	75	(34)	29	(.82)	87	(39.4)	33	(.93)
59 7/8"	65	(29.4)	25	(.71)	76	(34.4)	30	(.85)	89	(40)	34	(.96)
61 5/8"	67	(30.3)	26	(.74)	78	(35.3)	30	(.85)	91	(41.2)	35	(.99)
62 7/8"	68	(30.8)	26	(.74)	79	(35.8)	31	(.88)	92	(41.7)	36	(1.0)
64 5/8"	70	(31.7)	27	(.76)	81	(36.7)	32	(.91)	94	(42.6)	37	(1.0)
65 7/8"	71	(32.2)	28	(.79)	82	(37)	33	(.93)	95	(43)	38	(1.0)
67 5/8"	73	(33)	28	(.79)	84	(38)	33	(.93)	97	(43.9)	38	(1.0)
68 7/8"	74	(33.5)	29	(.82)	85	(38.5)	34	(.96)	98	(44.4)	39	(1.1)
70 5/8"	75	(34)	29	(.82)	86	(39)	35	(.99)	99	(44.9)	40	(1.1)
71 7/8"	76	(34.4)	30	(.85)	87	(39.4)	36	(1.0)	100	(45)	41	(1.1)
73 5/8"	78	(35.3)	31	(.88)	89	(40)	36	(1.0)	102	(46.2)	42	(1.2)
74 7/8"	79	(35.8)	31	(.88)	90	(40.8)	37	(1.0)	103	(46.7)	43	(1.2)
76 5/8"	81	(36.7)	32	(.91)	92	(41.7)	37	(1.0)	104	(47)	43	(1.2)
77 7/8"	82	(37)	32	(.91)	93	(42)	37	(1.0)	105	(47.6)	43	(1.2)
79 5/8"	84	(38)	33	(.93)	95	(43)	39	(1.1)	—	—	—	—



---

# 9900 Series Pedestals



# 9900 Series Pedestals

## ANSI/BIFMA

With the addition of counterweights where appropriate, pedestals meet all ANSI/BIFMA specifications.

## Construction

Pedestals are welded, “wrap-around” construction. 9900 Series pedestals uses 18 and 20 gauge steel. All pedestals use high quality, tension level, cold rolled steel. The steel gauges selected for drawer fronts, bodies and accessories ensure the highest quality durability and performance for all components.

## Construction features & benefits

1. “Wrap-around” construction with no visible vertical seams gives a clean appearance.
2. Completely enclosed case provides rigid construction and dust-free interiors.
3. Box drawer sides are slotted on 1” centers to allow for maximum flexibility for drawer division.
4. File (10½” and 12”) drawer bodies have full-height sides to accommodate hanging file folders, eliminating the need for optional file frames.
5. Fully-progressive ball bearing suspensions on all drawers, including pencil and box drawers, are staged so that left and right sides work in unison. This provides smooth drawer operation with minimum force.
6. Staged suspensions allow the drawer to be completely pulled out, providing access to the entire drawer depth.
7. Special “claw-like” device incorporated in the suspension “grips” the fixed section of the suspension arm preventing drawer bounce-back or creep when drawer is closed.
8. Casters and glides are both recessed “inboard” for a uniform exterior appearance with no visible hardware.
9. Modular interior allows for complete interchangeability of drawer types within the pedestal case. For example, two 6” box drawers may be replaced by one 12” file drawer.

## Counterweights

Counterweights are required for ALL freestanding units that are not anchored or ganged to other cabinets or bolted to walls/floor. Counterweights come standard with ALL mobile pedestals and must be field installed.

## Casters

Four swivel, recessed 1½” black, double-wheel phenolic carpet casters are supplied with mobile pedestals and must be field installed. Recessed casters are not visible.

## Drawer Standard Equipment

15” letter width storage drawers: 3” pencil drawer, 6” box drawer, 10½” and 12” file drawer are standard.

Pedestals containing 3” or 6” drawers are provided with one pencil tray per pedestal. 6” drawers are additionally standard with one steel divider.

18” legal width storage drawers: 3” pencil drawer, 6” box drawer, 10½” and 12” file drawer are standard. 10½” and 12” file drawer will house suspended legal-size folders front-to-back.

10½” and 12” letter-width file drawers have one suspension bar (two in a 28” deep pedestal) for side-to-side filing of legal or letter-size folders.

## Bases

Optional base aprons are available in 2 standard heights and are screwed to the underside of the pedestal case. Bases may be easily added or changed on site. When ordered, shipped with bases installed.

## Glides

Overall heights are inclusive of metal glides. Heights may be increased up to ⅝” by extending standard glide. Glides are accessible from inside the pedestal when the bottom drawer is fully extended or removed and may be adjusted with a ¼” socket driver.

Optional 1½” stem glides are available. Specify separately and add \$26 list to the pedestal price. Requires field installation.

## Locks

Pedestals come standard with lock. If lock is not required add suffix ‘/NL’ after product number. Deduct \$50 list per lock. For lock location, see the guide at the beginning of this price list. Mobile pedestals must include locks.

Random keying is standard. Pedestals may be ordered keyed alike. Specify. Locks feature removable core and are standard with two keys, one of which has a black neoprene plastic key cover.

Pedestals originally ordered as non-locking may be field installed with the addition of locking bars and a lock core.

Please contact Client Services for assistance.

Master keys are available at \$45 list.

## Finishes

Refer to Finishes section for color options. For lock finish options, refer to the front of this price list.

## Drawer Pulls

9900 Series fronts have full width integral pulls with enamel finish to match case fronts.

# 9900 Series Pedestals

## Freestanding, Letter Width

### How to order

1. Specify product number.
2. Specify finish color.
3. Specify options.

### Product code key example

#### 1522E-B7FM

<b>15</b>	pedestal width
<b>22</b>	pedestal depth
<b>E</b>	9900 Series
<b>B7</b>	7½" box drawer
<b>F</b>	12" file drawer
<b>M</b>	mobile

### General information

Pedestals are standard with either glides or casters. Exterior pedestal heights are nominal. Actual heights (with glides fully recessed) are ½" less. **Pedestal depths are nominal. Actual depth for 9900 Series are ¾" more than noted.** Casters must be field installed. Pedestals with 3" or 6" drawers are standard with one pencil tray per pedestal and one steel divider per 6" drawer. 10½" and 12" drawers have one suspension bar (two in a 28" deep pedestal) for side-to-side filing of letter or legal size folders.

Optional handle for mobile cushion pedestals, \$28 list.

### Accessories

See Pedestal Accessories section for counterweights and accessories.

### Lock option

Pedestals come standard with lock. If lock is not required add suffix '/NL' after product number. Deduct \$50 list.

### Finishes

Refer to Finishes section for color options. Drawer bodies and accessories are finished in Eco Black.

### Counterweights

Counterweights are required for ALL freestanding units that are not anchored or ganged to other cabinets or bolted to walls/floor. Counterweights are standard with all mobile pedestals and must be field installed. See Counterweight matrix on page 023.

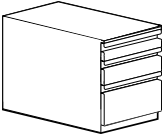
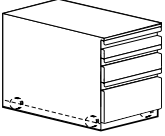
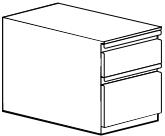
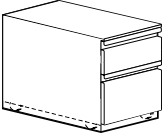
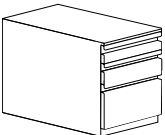
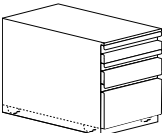
Description	Part number	Exterior Height	Case depth	Weight (lbs)	9900 series/ Neutral paint	Accent paint	
	1-3" pencil, 1-6" box, 1-10.5" file glides	<b>1518E-PBF10</b>	22 ¾"	18"	75	\$806	+\$82
		<b>1522E-PBF10</b>	22 ¾"	22"	85	\$899	+\$91
		<b>1528E-PBF10</b>	22 ¾"	28"	95	\$945	+\$96
	1-3" pencil, 1-6" box, 1-10.5" file, mobile, counterweights are included	<b>1518E-PBF10M</b>	23"	18"	80	\$875	+\$99
		<b>1522E-PBF10M</b>	23"	22"	90	\$850	+\$108
	Mobile pedestals must be locking	<b>1528E-PBF10M</b>	23"	28"	100	\$1025	+\$113
	1-7.5" box, 1-12" file glides	<b>1518E-B7F</b>	22 ¾"	18"	75	\$710	+\$73
		<b>1522E-B7F</b>	22 ¾"	22"	85	\$787	+\$81
		<b>1528E-B7F</b>	22 ¾"	28"	95	\$821	+\$84
	1-7.5" box, 1-12" file, mobile, counterweights are included	<b>1518E-B7FM</b>	23"	18"	80	\$878	+\$89
		<b>1522E-B7FM</b>	23"	22"	90	\$955	+\$97
	Mobile pedestals must be locking	<b>1528E-B7FM</b>	23"	28"	100	\$988	+\$100
	1-3" pencil, 1-6" box, 1-12" file glides	<b>1518E-PBF</b>	23 7/8"	18"	75	\$806	+\$82
		<b>1522E-PBF</b>	23 7/8"	22"	85	\$899	+\$91
		<b>1528E-PBF</b>	23 7/8"	28"	95	\$945	+\$96
	1-3" pencil, 1-6" box, 1-12" file, mobile, counterweights are included	<b>1518E-PBFM</b>	24 ½"	18"	80	\$875	+\$99
		<b>1522E-PBFM</b>	24 ½"	2"	90	\$950	+\$108
	Mobile pedestals must be locking	<b>1528E-PBFM</b>	24 ½"	28"	100	\$1025	+\$113

# 9900 Series Pedestals

## Freestanding, Letter Width

### How to order

1. Specify product number.
2. Specify finish color.
3. Specify options.

### Product code key example

#### 1522E-2F10.5M

- 15** pedestal width  
**22** pedestal depth  
**E** 9900 Series  
**2** number of drawers  
**F10.5** 10½" file drawer  
**M** mobile

### General information

Pedestals are standard with either glides or casters. Exterior pedestal heights are nominal. Actual heights (with glides fully recessed) are ⅛" less. **Pedestal depths are nominal. Actual depth for 9900 Series are ¾" more than noted.** Casters must be field installed. Pedestals with 3" or 6" drawers are standard with one pencil tray per pedestal and one steel divider per 6" drawer. 10½" and 12" drawers have one suspension bar (two in a 28" deep pedestal) for side-to-side filing of letter or legal size folders.

Optional handle for mobile cushion pedestals, \$28 list.

### Accessories

See Pedestal Accessories section for counterweights and accessories.

### Lock option

Pedestals come standard with lock. If lock is not required add suffix 'NL' after product number. Deduct \$50 list.

### Finishes

Refer to Finishes section for color options. Drawer bodies and accessories are finished in Eco Black.

### Counterweights

Counterweights are required for ALL freestanding units that are not anchored or ganged to other cabinets or bolted to walls/floor. Counterweights are standard with all mobile pedestals and must be field installed. See Counterweight matrix on page 023.

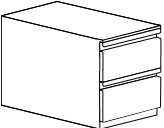
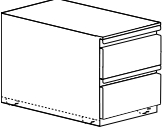
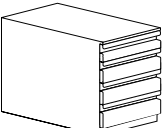
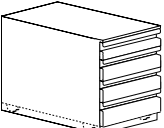
Description	Part number	Exterior Height	Case depth	Weight (lbs)	9900 series/ Neutral paint	Accent paint	
	2-10.5" file glides	<b>1518E-2F10.5</b>	23 7/8"	18"	75	\$758	+\$78
		<b>1522E-2F10.5</b>	23 7/8"	22"	85	\$821	+\$84
		<b>1528E-2F10.5</b>	23 7/8"	28"	95	\$853	+\$87
	2-10.5" file, mobile, counterweights are included	<b>1518E-2F10.5M</b>	24 1/2"	18"	80	\$926	+\$94
		<b>1522E-2F10.5M</b>	24 1/2"	22"	90	\$988	+\$100
	Mobile pedestals must be locking	<b>1528E-2F10.5M</b>	24 1/2"	28"	100	\$1022	+\$103
	1-3" pencil, 3-6" box glides	<b>1518E-P3B</b>	23 7/8"	18"	75	\$871	+\$89
		<b>1522E-P3B</b>	23 7/8"	22"	85	\$1009	+\$102
		<b>1528E-P3B</b>	23 7/8"	28"	95	\$1067	+\$108
	1-3" pencil, 3-6" box, mobile, counterweights are included	<b>1518E-P3BM</b>	24 1/2"	18"	80	\$1038	+\$106
		<b>1522E-P3BM</b>	24 1/2"	22"	90	\$1178	+\$119
	Mobile pedestals must be locking	<b>1528E-P3BM</b>	24 1/2"	28"	100	\$1235	+\$125

### How to order

1. Specify product number.
2. Specify finish color.
3. Specify options.

### Product code key example

#### 1522E-2BF10M

**15** pedestal width  
**22** pedestal depth  
**E** 9900 Series  
**2B** 2 box drawers  
**F10** 10½" file drawer  
**M** mobile

### General information

Pedestals are standard with either glides or casters. Exterior pedestal heights are nominal. Actual heights (with glides fully recessed) are ⅛" less. **Pedestal depths are nominal. Actual depth for 9900 Series are ¾" more than noted.** Casters must be field installed. Pedestals with 3" or 6" drawers are standard with one pencil tray per pedestal and one steel divider per 6" drawer. 10½" and 12" drawers have one suspension bar (two in a 28" deep pedestal) for side-to-side filing of letter or legal size folders.

Optional handle for mobile cushion pedestals, \$28 list.

### Accessories

See Pedestal Accessories section for counterweights and accessories.

### Lock option

Pedestals come standard with lock. If lock is not required add suffix '/NL' after product number. Deduct \$50 list.

### Finishes

Refer to Finishes section for color options. Drawer bodies and accessories are finished in Eco Black.

### Counterweights

Counterweights are required for ALL freestanding units that are not anchored or ganged to other cabinets or bolted to walls/floor. Counterweights are standard with all mobile pedestals and must be field installed. See Counterweight matrix on page 023.

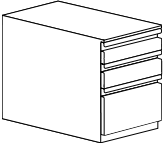
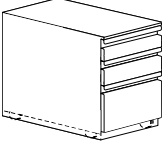
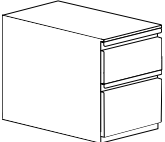
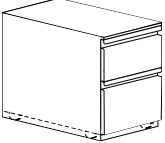
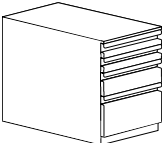
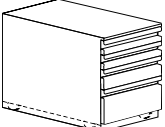
Description	Part number	Exterior Height	Case depth	Weight (lbs)	9900 series/ Neutral paint	Accent paint	
	2-6" box, 1-10.5" file glides	<b>1518E-2BF10</b>	25 ¾"	18"	80	\$822	+\$84
		<b>1522E-2BF10</b>	25 ¾"	22"	90	\$931	+\$94
		<b>1528E-2BF10</b>	25 ¾"	28"	100	\$975	+\$99
	2-6" box, 1-10.5" file, mobile, counterweights are included	<b>1518E-2BF10M</b>	26"	18"	85	\$990	+\$100
	Mobile pedestals must be locking	<b>1522E-2BF10M</b>	26"	22"	95	\$1098	+\$111
		<b>1528E-2BF10M</b>	26"	28"	105	\$1143	+\$116
	1-10.5" file, 1-12" file glides	<b>1518E-F10F</b>	25 ¾"	18"	80	\$758	+\$78
		<b>1522E-F10F</b>	25 ¾"	22"	90	\$821	+\$84
		<b>1528E-F10F</b>	25 ¾"	28"	100	\$853	+\$87
	1-10.5" file, 1-12" file, mobile, counterweights are included	<b>1518E-F10FM</b>	26"	18"	85	\$926	+\$94
	Mobile pedestals must be locking	<b>1522E-F10FM</b>	26"	22"	95	\$988	+\$100
		<b>1528E-F10FM</b>	26"	28"	105	\$1022	+\$103
	2-3" pencil, 1-6" box, 1-10.5" file glides	<b>1518E-2PBF10</b>	25 ¾"	18"	80	\$901	+\$92
		<b>1522E-2PBF10</b>	25 ¾"	22"	90	\$1010	+\$102
		<b>1528E-2PBF10</b>	25 ¾"	28"	100	\$1072	+\$109
	2-3" pencil, 1-6" box, 1-10.5" file, mobile, counterweights are included	<b>1518E-2PBF10M</b>	26"	18"	85	\$1072	+\$109
	Mobile pedestals must be locking	<b>1522E-2PBF10M</b>	26"	22"	95	\$1179	+\$119
		<b>1528E-2PBF10M</b>	26"	28"	105	\$1239	+\$125

# 9900 Series Pedestals

## Freestanding, Letter Width

### How to order

1. Specify product number.
2. Specify finish color.
3. Specify options.

### Product code key example

#### 1522E-B4B7FM

- 15** pedestal width
- 22** pedestal depth
- E** 9900 Series
- B4** 4½" box drawer
- B7** 7½" box drawer
- F** 12" file drawer
- M** mobile

### General information

Pedestals are standard with either glides or casters. Exterior pedestal heights are nominal. Actual heights (with glides fully recessed) are ⅛" less. **Pedestal depths are nominal. Actual depth for 9900 Series are ¾" more than noted.** Casters must be field installed. Pedestals with 3" or 6" drawers are standard with one pencil tray per pedestal and one steel divider per 6" drawer. 10½" and 12" drawers have one suspension bar (two in a 28" deep pedestal) for side-to-side filing of letter or legal size folders.

Optional handle for mobile cushion pedestals, \$28 list.

27 ½"h mobile pedestals do NOT fit under a standard 28.5"h worksurface.

### Accessories

See Pedestal Accessories section for counterweights and accessories.

### Lock option

Pedestals come standard with lock. If lock is not required add suffix '/NL' after product number. Deduct \$50 list.

### Finishes

Refer to Finishes section for color options. Drawer bodies and accessories are finished in Eco Black.

### Counterweights

Counterweights are required for ALL freestanding units that are not anchored or ganged to other cabinets or bolted to walls/floor. Counterweights are standard with all mobile pedestals and must be field installed. See Counterweight matrix on page 023.

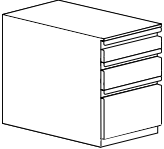
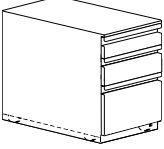
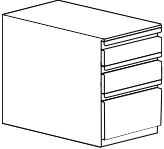
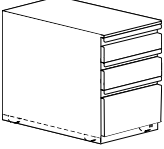
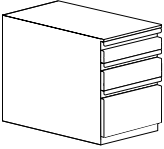
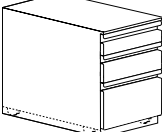
Description	Part number	Exterior Height	Case depth	Weight (lbs)	9900 series/ Neutral paint	Accent paint
 1-4.5" box, 1-7.5" box, 1-12" file glides	<b>1518E-B4B7F</b>	26 ⅞"	18"	80	\$750	+\$84
	<b>1522E-B4B7F</b>	26 ⅞"	22"	90	\$825	+\$94
	<b>1528E-B4B7F</b>	26 ⅞"	28"	100	\$900	+\$99
 1-4.5" box, 1-7.5" box, 1-12" file, mobile, counterweights are included Mobile pedestals must be locking	<b>1518E-B4B7FM</b>	27 ½"	18"	85	\$990	+\$100
	<b>1522E-B4B7FM</b>	27 ½"	22"	95	\$1098	+\$111
	<b>1528E-B4B7FM</b>	27 ½"	28"	105	\$1143	+\$116
 1-6" box, 1-7.5" box, 1-10.5" file glides	<b>1518E-BB7F10</b>	26 ⅞"	18"	80	\$750	+\$84
	<b>1522E-BB7F10</b>	26 ⅞"	22"	90	\$825	+\$94
	<b>1528E-BB7F10</b>	26 ⅞"	28"	100	\$900	+\$99
 1-6" box, 1-7.5" box, 1-10.5" file, mobile, counterweights are included Mobile pedestals must be locking	<b>1518E-BB7F10M</b>	27 ½"	18"	85	\$990	+\$100
	<b>1522E-BB7F10M</b>	27 ½"	22"	95	\$1098	+\$111
	<b>1528E-BB7F10M</b>	27 ½"	28"	105	\$1143	+\$116
 2-6" box, 1-12" file glides	<b>1518E-2BF</b>	26 ⅞"	18"	80	\$750	+\$84
	<b>1522E-2BF</b>	26 ⅞"	22"	90	\$825	+\$94
	<b>1528E-2BF</b>	26 ⅞"	28"	100	\$900	+\$99
 2-6" box, 1-12" file, mobile, counterweights are included Mobile pedestals must be locking	<b>1518E-2BFM</b>	27 ½"	18"	85	\$990	+\$100
	<b>1522E-2BFM</b>	27 ½"	22"	95	\$1098	+\$111
	<b>1528E-2BFM</b>	27 ½"	28"	105	\$1143	+\$116

### How to order

1. Specify product number.
2. Specify finish color.
3. Specify options.

### Product code key example

#### 1522E-2FM

- 15** pedestal width
- 22** pedestal depth
- E** 9900 Series
- 2** number of drawers
- F** 12" file drawer
- M** mobile

### General information

Pedestals are standard with either glides or casters. Exterior pedestal heights are nominal. Actual heights (with glides fully recessed) are  $\frac{1}{8}$ " less. **Pedestal depths are nominal. Actual depth for 9900 Series are  $\frac{3}{4}$ " more than noted.** Casters must be field installed. Pedestals with 3" or 6" drawers are standard with one pencil tray per pedestal and one steel divider per 6" drawer. 10 $\frac{1}{2}$ " and 12" drawers have one suspension bar (two in a 28" deep pedestal) for side-to-side filing of letter or legal size folders.

Optional handle for mobile cushion pedestals, \$28 list.

27  $\frac{1}{2}$ "h mobile pedestals do NOT fit under a standard 28.5"h worksurface.

### Accessories

See Pedestal Accessories section for counterweights and accessories.

### Lock option

Pedestals come standard with lock. If lock is not required add suffix '/NL' after product number. Deduct \$50 list.

### Finishes

Refer to Finishes section for color options. Drawer bodies and accessories are finished in Eco Black.

### Counterweights

Counterweights are required for ALL freestanding units that are not anchored or ganged to other cabinets or bolted to walls/floor. Counterweights are standard with all mobile pedestals and must be field installed. See Counterweight matrix on page 023.

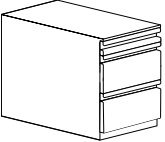
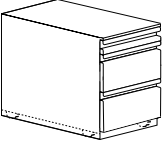
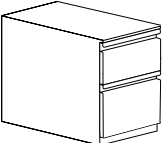
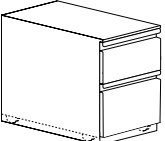
Description	Part number	Exterior Height	Case depth	Weight (lbs)	9900 series/ Neutral paint	Accent paint
 1-3" pencil, 2-10.5" file glides	<b>1518E-P2F10.5</b>	26 $\frac{7}{8}$ "	18"	80	\$800	+\$87
	<b>1522E-P2F10.5</b>	26 $\frac{7}{8}$ "	22"	90	\$835	+\$95
	<b>1528E-P2F10.5</b>	26 $\frac{7}{8}$ "	28"	100	\$900	+\$99
 1-3" pencil, 2-10.5" file, mobile, counterweights are included Mobile pedestals must be locking	<b>1518E-P2F10.5M</b>	27 $\frac{1}{2}$ "	18"	85	\$1022	+\$103
	<b>1522E-P2F10.5M</b>	27 $\frac{1}{2}$ "	22"	95	\$1100	+\$112
	<b>1528E-P2F10.5M</b>	27 $\frac{1}{2}$ "	28"	105	\$1146	+\$116
 2-12" file glides	<b>1518E-2F</b>	26 $\frac{7}{8}$ "	18"	80	\$650	+\$78
	<b>1522E-2F</b>	26 $\frac{7}{8}$ "	22"	90	\$705	+\$84
	<b>1528E-2F</b>	26 $\frac{7}{8}$ "	28"	100	\$775	+\$87
 2-12" file, mobile, counterweights are included Mobile pedestals must be locking	<b>1518E-2FM</b>	27 $\frac{1}{2}$ "	18"	85	\$926	+\$94
	<b>1522E-2FM</b>	27 $\frac{1}{2}$ "	22"	95	\$988	+\$100
	<b>1528E-2FM</b>	27 $\frac{1}{2}$ "	28"	105	\$1022	+\$103

### CONSIDER THIS!

At the same height get a personal drawer with your 2 file drawers!

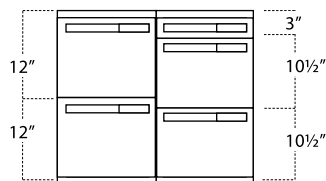



# 9900 Series Pedestals

## Freestanding, Letter Width

### How to order

1. Specify product number.
2. Specify finish color.
3. Specify options.

### Product code key example

#### 1522E-4BM

**15** pedestal width  
**22** pedestal depth  
**E** 9900 Series  
**4B** 4 box drawers  
**M** mobile

### General information

Pedestals are standard with either glides or casters. Exterior pedestal heights are nominal. Actual heights (with glides fully recessed) are 1/8" less. **Pedestal depths are nominal. Actual depth for 9900 Series are 3/4" more than noted.** Casters must be field installed. Pedestals with 3" or 6" drawers are standard with one pencil tray per pedestal and one steel divider per 6" drawer. 10 1/2" and 12" drawers have one suspension bar (two in a 28" deep pedestal) for side-to-side filing of letter or legal size folders.

Optional handle for mobile cushion pedestals, \$28 list.

27 1/2" h mobile pedestals do NOT fit under a standard 28.5" h worksurface.

### Accessories

See Pedestal Accessories section for counterweights and accessories.

### Lock option

Pedestals come standard with lock. If lock is not required add suffix '/NL' after product number. Deduct \$50 list.

### Finishes

Refer to Finishes section for color options. Drawer bodies and accessories are finished in Eco Black.

### Counterweights

Counterweights are required for ALL freestanding units that are not anchored or ganged to other cabinets or bolted to walls/floor. Counterweights are standard with all mobile pedestals and must be field installed. See Counterweight matrix on page 023.

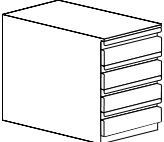
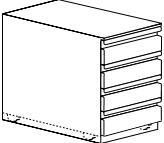
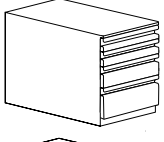
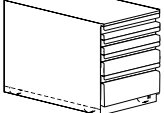
Description	Part number	Exterior Height	Case depth	Weight (lbs)	9900 series/ Neutral paint	Accent paint
 4-6" box glides	<b>1518E-4B</b>	26 7/8"	18"	80	\$887	+\$90
	<b>1522E-4B</b>	26 7/8"	22"	90	\$1040	+\$106
	<b>1528E-4B</b>	26 7/8"	28"	100	\$1096	+\$111
 4-6" box, mobile, counterweights are included Mobile pedestals must be locking	<b>1518E-4BM</b>	27 1/2"	18"	85	\$1055	+\$107
	<b>1522E-4BM</b>	27 1/2"	22"	95	\$1209	+\$122
	<b>1528E-4BM</b>	27 1/2"	28"	105	\$1265	+\$127
 2-3" pencil, 1-6" box, 1-12" file glides	<b>1518E-2PBF</b>	26 7/8"	18"	80	\$901	+\$92
	<b>1522E-2PBF</b>	26 7/8"	22"	90	\$1010	+\$102
	<b>1528E-2PBF</b>	26 7/8"	28"	100	\$1072	+\$109
 2-3" pencil, 1-6" box, 1-12" file, mobile, counterweights are included Mobile pedestals must be locking	<b>1518E-2PBFM</b>	27 1/2"	18"	85	\$1072	+\$109
	<b>1522E-2PBFM</b>	27 1/2"	22"	95	\$1179	+\$119
	<b>1528E-2PBFM</b>	27 1/2"	28"	105	\$1239	+\$125

### How to order

1. Specify product number.
2. Specify finish color.
3. Specify options.

### Product code key example

#### 1822E-2BF10

**18** pedestal width  
**22** pedestal depth  
**E** 9900 Series  
**2B** 2 box drawers  
**F10** 10½" file drawer

### General information

Pedestals are standard with either glides or casters. Exterior pedestal heights are nominal. Actual heights (with glides fully recessed) are ½" less. **Pedestal depths are nominal. Actual depth for 9900 Series are ¾" more than noted.** Casters must be field installed. Pedestals with 3" or 6" drawers are standard with one pencil tray per pedestal and one steel divider per 6" drawer. 10½" and 12" drawers have one suspension bar (two in a 28" deep pedestal) for side-to-side filing of letter or legal size folders.

Optional handle for mobile cushion pedestals, \$28 list.

### Accessories

See Pedestal Accessories section for counterweights and accessories.

### Lock option

Pedestals come standard with lock. If lock is not required add suffix '/NL' after product number. Deduct \$50 list.

### Finishes

Refer to Finishes section for color options. Drawer bodies and accessories are finished in Eco Black.

### Counterweights

Counterweights are required for ALL freestanding units that are not anchored or ganged to other cabinets or bolted to walls/floor. See Counterweight matrix on page 023.

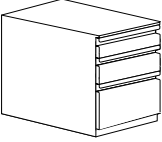
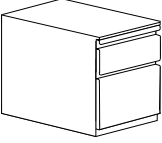
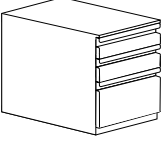
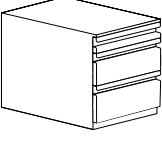
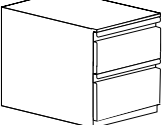
Description	Part number	Exterior Height	Case depth	Weight (lbs)	9900 series/ Neutral paint	Accent paint
 2-6" box, 1-10.5" file glides	<b>1822E-2BF10</b>	25 ¾"	22"	85	\$1083	+\$110
	<b>1828E-2BF10</b>	25 ¾"	28"	95	\$1137	+\$115
 1-10.5" file, 1-12" file glides	<b>1822E-F10F</b>	25 ¾"	22"	85	\$958	+\$97
	<b>1828E-F10F</b>	25 ¾"	28"	95	\$998	+\$101
 2-6" box, 1 file glides	<b>1822E-2BF</b>	26 7/8"	22"	85	\$1083	+\$110
	<b>1828E-2BF</b>	26 7/8"	28"	95	\$1137	+\$115
 1-3" pencil, 2-10.5" file glides	<b>1822E-P2F10.5</b>	26 7/8"	22"	85	\$1084	+\$110
	<b>1828E-P2F10.5</b>	26 7/8"	28"	95	\$1133	+\$115
 2-12" file glides	<b>1822E-2F</b>	26 7/8"	22"	85	\$958	+\$97
	<b>1828E-2F</b>	26 7/8"	28"	95	\$998	+\$101

# 9900 Series Pedestals

## Cushion Pedestals

### How to order

1. Specify product number.
2. Specify finish color.
3. Specify options.

### Product code key example

#### 1522E-BFMC

- 15** pedestal width
- 22** pedestal depth
- E** 9900 Series
- B** box drawer
- F** 12" file drawer
- M** mobile
- C** cushion

### General information

#### Pedestal depths are nominal. Actual depth 9900 Series are 3/4" more than noted.

Cushion Mobile pedestals are topped with a 1 1/4" thick CAL 117 fire-retardant polyurethane foam with a 2.2 lb/ft. density. This upholstered cushion is balanced with a 7/16" board and is attached to the pedestal top with Velcro. For application of ALL fabrics, both from our graded program as well as COM (customers own material), please specify layup orientation at time of order. If layup instructions are not provided we will choose the direction to maximize our production. Refer to page 15 for additional layout and COM details.

Casters must be field installed.

Optional handle for mobile cushion pedestals, \$28 list.

### Counterweights

Counterweights are required for ALL freestanding units that are not anchored or ganged to other cabinets or bolted to walls/floor. Counterweights are standard with all mobile pedestals and must be field installed. See Counterweight matrix on page 023.

### Accessories

See Pedestal Accessories section for counterweights and accessories.

### Lock option

Pedestals come standard with lock. If lock is not required add suffix 'NL' after product number. Deduct \$50 list.

### Finishes

Refer to Finishes section for color options. Drawer bodies and accessories are finished in Eco Black.

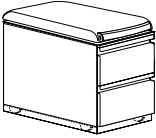
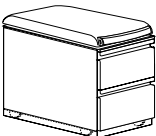
Description	Part number	Exterior Height	Case depth	Weight (lbs)	9900 series/ Neutral paint	Accent paint
 <p>Cushion pedestal 1-6" box, 1-12" file drawer, mobile, counterweights are included Mobile pedestals must be locking</p>	<b>1518E-BFMC</b>	22 1/2"	18"	93	\$900	+\$103
	<b>1522E-BFMC</b>	22 1/2"	22"	105	\$950	+\$108
	<b>1528E-BFMC</b>	22 1/2"	28"	117	\$1010	+\$112
 <p>Cushion pedestal 1-7.5" box, 1-10.5" file drawer, mobile, counterweights are included Mobile pedestals must be locking</p>	<b>1518E-B7F10MC</b>	22 1/2"	18"	93	\$1020	+\$103
	<b>1522E-B7F10MC</b>	22 1/2"	22"	105	\$1060	+\$108
	<b>1528E-B7F10MC</b>	22 1/2"	28"	117	\$1103	+\$112

### Fabric upcharge for mobile cushion pedestals

**Note: To price fabric grade options, add the upcharge (+\$) in the chart below to the base price of the List price (Grade A) column This will be the total cost for that product.**

Grade B/COM	Grade C	Grade D	Grade E	Grade F
+\$50	+\$92	+\$130	+\$156	+\$223

### How to order

1. Specify product number.
2. Specify finish color.
3. Specify options.

### Product code key example

**1522E-2F10TB-2**

**15** pedestal width  
**22** pedestal depth  
**E** 9900 Series  
**2** number of drawers  
**F10** 10½" file drawer  
**TB-2** number of locking tie bar shelves

### General information

Pedestals are standard with either glides or casters. Exterior pedestal heights are nominal. Actual heights (with glides fully recessed) are ½" less. **Pedestal depths are nominal. Actual depth for 9900 Series are ¾" more than noted.** Casters must be field installed. Pedestals with 3" or 6" drawers are standard with one pencil tray per pedestal and one steel divider per 6" drawer. 10½" and 12" drawers have one suspension bar (two in a 28" deep pedestal) for side-to-side filing of letter or legal size folders.

### Accessories

See Pedestal Accessories section for counterweights and accessories.

### Lock option

Pedestal drawers lock individually. If lock is not required add suffix 'N/L' after product number. Deduct \$50 list.

### Finishes

Refer to Finishes section for color options. Drawer bodies and accessories are finished in Eco Black.

### Counterweights

Counterweights are required for ALL freestanding units that are not anchored or ganged to other cabinets or bolted to walls/floor. See Counterweight matrix on page 023.

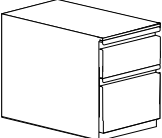
Description	Part number	Exterior Height	Case depth	Weight (lbs)	9900 series/ Neutral paint	Accent paint
 Pedestal with 2-10 ½" individual locking drawers. Locks and security shelf are included. Locks are keyed differently.	<b>1522E-2F10TB-2</b>	25 ¾"	22"	105	\$1129	+\$114
	<b>1528E-2F10TB-2</b>	25 ¾"	28"	117	\$1160	+\$117

Left blank intentionally.

---

# 9900 Series Laterals



# 9900 Series Laterals

## ANSI/BIFMA

With the addition of counterweights where appropriate, lateral files meet all ANSI/BIFMA specifications.

## Construction

Lateral files and hinged door cabinets are of all-welded construction using 20 and 22 gauge high quality, tension leveled, cold rolled steel. The steel gauges selected for drawer fronts, bodies and accessories ensure the highest quality, durability and performance for all components.

## Construction features & benefits

1. All interiors are modular and interchangeable so that cabinets can be retrofitted with new accessories and interiors as required.
2. Corners are strengthened with a reinforcing gusset and are welded at junction of top and case fronts, eliminating horizontal lines for a cleaner, flush appearance on the face of the cabinet.
3. Full width pulls allow lift-up doors and drawers to be opened from any position.
4. Rigid construction allows lift-up doors to be picked up and retracted smoothly from any point, eliminates deformation, ensures flush fit within the cabinet and improves lock performance.
5. Lift-up door carrier mechanism has four nylon rollers, two on each side, for smooth receding action with no binding or snagging.
6. Front leading edge of pullout shelves is beaded and rolled to provide grip for pullout action and to strengthen shelf; front leading edge of fixed shelf is flat for easy removal of material.
7. Fully-progressive ball bearing suspensions are staged so that left and right sides work in unison. This provides smooth drawer operation with minimum force.
8. Special Claw-like device incorporated in suspensions "grips" the fixed section of the suspension arm preventing drawer bounce-back or creep when drawer is closed.
9. Lock bars operate vertically on both sides of the cabinet for maximum security.
10. Lock fingers are configured with right angle bend upward, not downward, so that lift-up doors cannot be pulled down to disengage fingers from door slots and be forced to circumvent lock system.
11. Plastic buttons in side gables of case where top sections of lift-up doors recede into the cabinet eliminate metal-to-metal contact.
12. Plastic buttons in the ends of each drawer and door front eliminates metal-to-metal contact between cabinet sides and closed drawers.
13. Self-closing, 110° opening, European style cupboard hinges provide smooth hinged door operation. Hinges are not visible from the exterior of the cabinet.

## Bases

Optional base aprons are available in 2 heights and are screwed to the underside of the cabinet. Bases may be easily added or changed on site. Cabinets are shipped with bases installed when ordered.

## Counterweights

Counterweights are required for ALL freestanding units that are not anchored or ganged to other cabinets or bolted to walls/floor.

## Safelock™

The patented Safelock mechanism provides complete security against accidental opening of two or more drawers simultaneously. When any drawer or single pullout shelf is extended, even fractionally, Safelock ensures that all other openings, except for the 3" and 4½" drawers, immediately become inoperable. Safelock is standard on all lateral files. The only exceptions are the 3" and 4½" drawers and the upper shelf in a two pullout shelf opening.

## Drawer Standard Equipment

Pullout drawers and shelves are standard with one pair hangfile bars for side-to-side suspended filing. Fixed shelves are standard with 3 plate dividers. Optional accessories are available.

## Glides

Overall heights are inclusive of metal glides. Heights may be increased up to ⅝" by extending standard glide. Glides are accessible from inside the cabinet when the bottom drawer is fully extended or removed and may be adjusted with a ¼" socket driver.

Optional 1½" stem glides are available.

Specify and add \$26 list to the cabinet price. Requires field installation.

## Locks

Cabinets come standard with lock. If lock is not required add suffix 'N/L' after product number. Deduct \$50 list per lock. For lock location, see diagrams at the front of this price list.

Note: 3" and 4½" drawers, when located immediately above a case bottom, tie bar shelf or reference shelves cannot be locked.

Random keying is standard. Files may be ordered keyed alike. Locks feature removable core and are standard with two keys, one of which has a black neoprene plastic key cover.

Cabinets originally ordered as non-locking may be field installed with the addition of locking bars and a lock core. Please contact Inscape Client Services for required parts.

Master keys are available at \$45 list.

## Lateral file tops

Refer to Accessories section to order Laminate, Nuform and Veneer tops.

## Finishes

Refer to Finishes section for color options. For lock finish options, refer to the front of this price list.

## Drawer Pulls

9900 Series fronts have full width integral pulls with enamel finish to match case fronts.

## How to order

1. Specify product number.
2. Specify finish color.
3. Specify options.

## Product code key example

### 36-21-2FFE

**36** cabinet width  
**21** interior height  
**2** number of drawers  
**FF** fixed front  
**E** 9900 Series

## General information

Exterior cabinet heights are nominal. Actual heights (with glides fully recessed) are 1/8" less. Cabinets are priced inclusive 1 pair of hangfile bars in each pullout opening and fixed shelves are standard with 3 plate dividers.

**Cabinets are 18" in depth.**

## Counterweights

Counterweights are required for ALL freestanding units that are not anchored or ganged to other cabinets or bolted to walls/floor. See Counterweight matrix on page 023.

## Accessories

See Lateral File Accessories section for counterweights and accessories.

## Lock option

Cabinets come standard with lock. If lock is not required add suffix '/NL' after product number. Deduct \$50 list.

## Finishes

Refer to Finishes section for color options. Drawer bodies and accessories are finished in Eco Black.

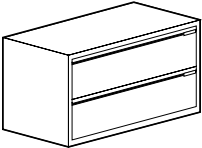
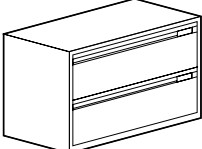
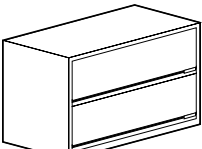
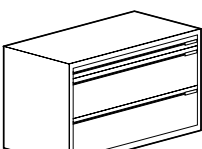
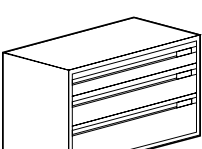
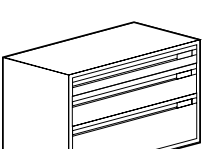
Description	Part number	Exterior height	Width	Weight (lbs)	9900 series/ Neutral paint	Accent paint	
	2 high cabinet	<b>30-21-2FFE</b>	23 7/8"	30"	80	\$950	+\$99
	2-10.5" fixed front drawers	<b>36-21-2FFE</b>	23 7/8"	36"	98	\$995	+\$109
		<b>42-21-2FFE</b>	23 7/8"	42"	116	\$1040	+\$119
	2 high cabinet	<b>24-2FFE</b>	26 7/8"	24"	90	\$900	+\$93
	2-12" fixed front drawers	<b>30-2FFE</b>	26 7/8"	30"	100	\$950	+\$99
		<b>36-2FFE</b>	26 7/8"	36"	120	\$995	+\$109
		<b>42-2FFE</b>	26 7/8"	42"	130	\$1040	+\$120
	2 high cabinet	<b>30-2ETE</b>	26 7/8"	30"	100	\$956	+\$97
	2-12" lift-up doors with fixed shelves	<b>36-2ETE</b>	26 7/8"	36"	120	\$1040	+\$106
		<b>42-2ETE</b>	26 7/8"	42"	130	\$1152	+\$117
	2 high cabinet	<b>30-24-P2FFE</b>	26 7/8"	30"	100	\$1172	+\$118
	top opening 3" drawer, other	<b>36-24-P2FFE</b>	26 7/8"	36"	120	\$1278	+\$129
	2 openings 10.5" fixed front drawers	<b>42-24-P2FFE</b>	26 7/8"	42"	130	\$1390	+\$140
	2 high cabinet	<b>30-24-BB7FE</b>	26 7/8"	30"	100	\$1142	+\$116
	1-6" drawer, 1-7.5" drawer	<b>36-24-BB7FE</b>	26 7/8"	36"	120	\$1254	+\$126
	and 1-10.5" fixed front drawer	<b>42-24-BB7FE</b>	26 7/8"	42"	130	\$1385	+\$140
	2 high cabinet	<b>30-24-B4B7FE</b>	26 7/8"	30"	100	\$1131	+\$115
	1-4.5" drawer, 1-7.5" drawer	<b>36-24-B4B7FE</b>	26 7/8"	36"	120	\$1233	+\$124
	and 1-12" fixed front drawer	<b>42-24-B4B7FE</b>	26 7/8"	42"	130	\$1339	+\$134



# 9900 Series Laterals

## Pre-configured

2 high

### How to order

1. Specify product number.
2. Specify finish color.
3. Specify options.

### Product code key example

#### 36-2LUE

- 36** cabinet width  
**2** number of doors  
**LU** lift-up door  
**E** 9900 Series

### General information

All 13.5" and 15" openings for 14 7/8" x 11" EDP printouts include EDP kit for side-to-side filing of Accodata type 2 point suspension binders. Exterior cabinet heights are nominal. Actual heights (with glides fully recessed) are 1/8" less. Cabinets are priced inclusive 1 pair of hangfile bars in each pullout opening and fixed shelves are standard with 3 plate dividers.

#### Cabinets are 18" in depth.

### Counterweights

Counterweights are required for ALL freestanding units that are not anchored or ganged to other cabinets or bolted to walls/floor. See Counterweight matrix on page 023.

### Accessories

See Lateral File Accessories section for counterweights and accessories.

### Lock option

Cabinets come standard with lock. If lock is not required add suffix '/NL' after product number. Deduct \$50 list.

### Finishes

Refer to Finishes section for color options. Drawer bodies and accessories are finished in Eco Black.

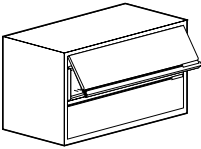
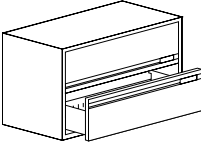
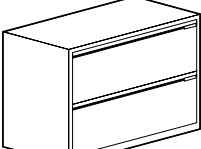
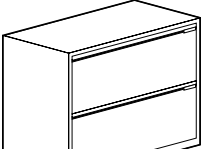
Description	Part number	Exterior height	Width	Weight (lbs)	9900 series/ Neutral paint	Accent paint
 <p>2 high cabinet top opening 13.5" lift-up door with fixed shelf, with 3 plate dividers, other opening 10.5" fixed front drawer</p>	<b>30-24-13LU10FE</b>	26 7/8"	30"	100	\$980	+\$99
	<b>36-24-13LU10FE</b>	26 7/8"	36"	120	\$1082	+\$110
	<b>42-24-13LU10FE</b>	26 7/8"	42"	130	\$1198	+\$121
 <p>2 high cabinet top opening 12" lift-up door with pullout shelf, bottom opening 12" fixed front drawer</p>	<b>30-2LUE</b>	26 7/8"	30"	100	\$982	+\$99
	<b>36-2LUE</b>	26 7/8"	36"	120	\$1078	+\$109
	<b>42-2LUE</b>	26 7/8"	42"	130	\$1184	+\$120
 <p>2 high cabinet 2-13.5" fixed front EDP drawers</p>	<b>30-27-2EDPE</b>	29 7/8"	30"	120	\$1172	+\$118
	<b>36-27-2EDPE</b>	29 7/8"	36"	130	\$1259	+\$127
	<b>42-27-2EDPE</b>	29 7/8"	42"	150	\$1385	+\$140
 <p>2 high cabinet 2-15" fixed front EDP drawers</p>	<b>30-30-2EDPE</b>	32 7/8"	30"	130	\$1188	+\$120
	<b>36-30-2EDPE</b>	32 7/8"	36"	140	\$1299	+\$131
	<b>42-30-2EDPE</b>	32 7/8"	42"	160	\$1438	+\$146

## How to order

1. Specify product number.
2. Specify finish color.
3. Specify options.

## Product code key example

### 36-31.5-3FFE

**36** cabinet width  
**31.5** interior height  
**3** number of drawers  
**FF** fixed front  
**E** 9900 Series

## General information

All 13.5" and 15" openings for 14 7/8" x 11" EDP printouts include EDP kit for side-to-side filing of Accodata type 2 point suspension binders. Exterior cabinet heights are nominal. Actual heights (with glides fully recessed) are 1/8" less. Cabinets are priced inclusive 1 pair of hangfile bars in each pullout opening and fixed shelves are standard with 3 plate dividers.

**Cabinets are 18" in depth.**

## Counterweights

Counterweights are required for ALL freestanding units that are not anchored or ganged to other cabinets or bolted to walls/floor. See Counterweight matrix on page 023.

## Accessories

See Lateral File Accessories section for counterweights and accessories.

## Lock option

Cabinets come standard with lock. If lock is not required add suffix '/NL' after product number. Deduct \$50 list.

## Finishes

Refer to Finishes section for color options. Drawer bodies and accessories are finished in Eco Black.

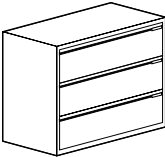
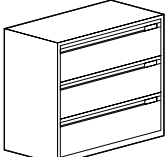
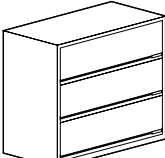
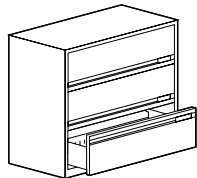
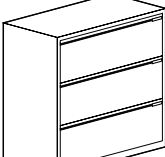
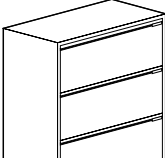
Description	Part number	Exterior height	Width	Weight (lbs)	9900 series/ Neutral paint	Accent paint	
	3 high cabinet	<b>30-31.5-3FFE</b>	34 3/8"	30"	120	\$1150	+\$132
	3-10.5" fixed front drawers	<b>36-31.5-3FFE</b>	34 3/8"	36"	140	\$1200	+\$147
		<b>42-31.5-3FFE</b>	34 3/8"	42"	160	\$1250	+\$163
	3 high cabinet	<b>30-3FFE</b>	38 7/8"	30"	130	\$1150	+\$133
	3-12" fixed front drawers	<b>36-3FFE</b>	38 7/8"	36"	150	\$1200	+\$148
		<b>42-3FFE</b>	38 7/8"	42"	170	\$1250	+\$165
	3 high cabinet	<b>30-3ETE</b>	38 7/8"	30"	130	\$1284	+\$129
	3-12" lift-up doors with fixed shelves	<b>36-3ETE</b>	38 7/8"	36"	150	\$1405	+\$143
		<b>42-3ETE</b>	38 7/8"	42"	170	\$1587	+\$160
	3 high cabinet	<b>30-3LUE</b>	38 7/8"	30"	130	\$1321	+\$133
	2- 12" lift-up doors with pullout shelves, bottom opening 1-12" fixed front drawer	<b>36-3LUE</b>	38 7/8"	36"	150	\$1460	+\$148
		<b>42-3LUE</b>	38 7/8"	42"	170	\$1637	+\$165
	3 high cabinet	<b>30-40.5-3EDPE</b>	43 3/8"	30"	135	\$1550	+\$157
	3-13.5" fixed front EDP drawers	<b>36-40.5-3EDPE</b>	43 3/8"	36"	155	\$1746	+\$176
		<b>42-40.5-3EDPE</b>	43 3/8"	42"	175	\$1947	+\$196
	3 high cabinet	<b>30-45-3EDPE</b>	47 7/8"	30"	145	\$1561	+\$158
	3-15" fixed front EDP drawers	<b>36-45-3EDPE</b>	47 7/8"	36"	165	\$1812	+\$183
		<b>42-45-3EDPE</b>	47 7/8"	42"	195	\$2036	+\$204

# 9900 Series Laterals

## Pre-configured

4 high

### How to order

1. Specify product number.
2. Specify finish color.
3. Specify options.

### Product code key example

**36-42-4FFE**

- 36** cabinet width
- 42** interior height
- 4** number of drawers
- FF** fixed front
- E** 9900 Series

### General information

Exterior cabinet heights are nominal. Actual heights (with glides fully recessed) are  $\frac{1}{8}$ " less. Cabinets are priced inclusive 1 pair of hangfile bars in each pullout opening and fixed shelves are standard with 3 plate dividers.

**Cabinets are 18" in depth.**

### Counterweights

Counterweights are required for ALL freestanding units that are not anchored or ganged to other cabinets or bolted to walls/floor. See Counterweight matrix on page 023.

### Accessories

See Lateral File Accessories section for counterweights and accessories.

### Lock option

Cabinets come standard with lock. If lock is not required add suffix '/NL' after product number. Deduct \$50 list.

### Finishes

Refer to Finishes section for color options. Drawer bodies and accessories are finished in Eco Black.

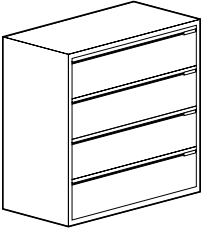
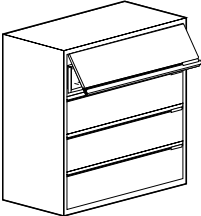
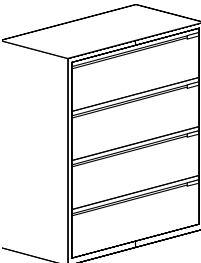
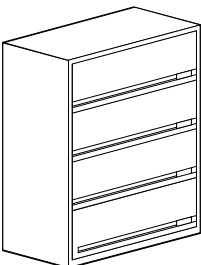
Description	Part number	Exterior height	Width	Weight (lbs)	9900 series/ Neutral paint	Accent paint
 <p>4 high cabinet 4-10.5" fixed front drawers</p>	<b>30-42-4FFE</b>	44 $\frac{7}{8}$ "	30"	140	\$1400	+\$163
	<b>36-42-4FFE</b>	44 $\frac{7}{8}$ "	36"	160	\$1475	+\$185
	<b>42-42-4FFE</b>	44 $\frac{7}{8}$ "	42"	180	\$1600	+\$210
 <p>4 high cabinet top opening 12" lift-up with pullout shelf, other 3 openings 10.5" fixed front drawers</p>	<b>30-43.5-4FFE</b>	46 $\frac{3}{8}$ "	30"	145	\$1619	+\$163
	<b>36-43.5-4FFE</b>	46 $\frac{3}{8}$ "	36"	165	\$1864	+\$188
	<b>42-43.5-4FFE</b>	46 $\frac{3}{8}$ "	42"	185	\$2113	+\$213
 <p>4 high cabinet 4- 12" - fixed front drawers</p>	<b>30-48-4FFE</b>	50 $\frac{7}{8}$ "	30"	170	\$1415	+\$163
	<b>36-48-4FFE</b>	50 $\frac{7}{8}$ "	36"	195	\$1490	+\$190
	<b>42-48-4FFE</b>	50 $\frac{7}{8}$ "	42"	230	\$1615	+\$216
 <p>4 high cabinet 4-12" lift-up doors with fixed shelves</p>	<b>30-48-4ETE</b>	50 $\frac{7}{8}$ "	30"	170	\$1707	+\$173
	<b>36-48-4ETE</b>	50 $\frac{7}{8}$ "	36"	195	\$2035	+\$204
	<b>42-48-4ETE</b>	50 $\frac{7}{8}$ "	42"	230	\$2286	+\$230

## How to order

1. Specify product number.
2. Specify finish color.
3. Specify options.

## Product code key example

### 36-4FFE

**36** cabinet width  
**4** number of drawers  
**FF** fixed front  
**E** 9900 Series

## General information

All 13.5" and 15" openings for 14 7/8" x 11" EDP printouts include EDP kit for side-to-side filing of Accodata type 2 point suspension binders. Exterior cabinet heights are nominal. Actual heights (with glides fully recessed) are 1/8" less. Cabinets are priced inclusive 1 pair of hangfile bars in each pullout opening and fixed shelves are standard with 3 plate dividers.

**Cabinets are 18" in depth.**

## Counterweights

Counterweights are required for ALL freestanding units that are not anchored or ganged to other cabinets or bolted to walls/floor. See Counterweight matrix on page 023.

## Accessories

See Lateral File Accessories section for counterweights and accessories.

## Lock option

Cabinets come standard with lock. If lock is not required add suffix '/NL' after product number. Deduct \$50 list.

## Finishes

Refer to Finishes section for color options. Drawer bodies and accessories are finished in Eco Black.

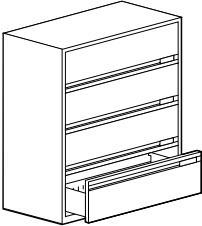
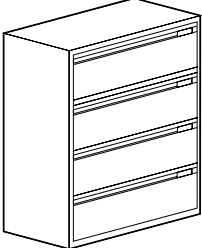
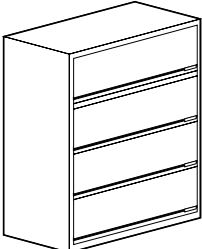
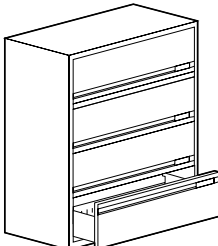
Description	Part number	Exterior height	Width	Weight (lbs)	9900 series/ Neutral paint	Accent paint
 <p>4 high cabinet 3-12" lift-up doors with pullout shelves, bottom opening 1-12" fixed front drawer</p>	<b>30-48-4LUE</b>	50 7/8"	30"	175	\$1913	+\$192
	<b>36-48-4LUE</b>	50 7/8"	36"	200	\$2210	+\$223
	<b>42-48-4LUE</b>	50 7/8"	42"	235	\$2569	+\$258
 <p>4 high cabinet 4-12" fixed front drawers, 1.5" tie bar</p>	<b>30-4FFE</b>	52 3/8"	30"	170	\$1425	+\$165
	<b>36-4FFE</b>	52 3/8"	36"	195	\$1500	+\$190
	<b>42-4FFE</b>	52 3/8"	42"	230	\$1625	+\$216
 <p>4 high cabinet 4-12" lift-up doors with fixed shelves, 1.5" tie bar</p>	<b>30-4ETE</b>	52 3/8"	30"	170	\$1584	+\$160
	<b>36-4ETE</b>	52 3/8"	36"	195	\$1816	+\$183
	<b>42-4ETE</b>	52 3/8"	42"	230	\$2076	+\$209
 <p>4 high cabinet 3-12" lift-up doors with pullout shelves, bottom opening 1-12" fixed front drawer, 1.5" tie bar</p>	<b>30-4LUE</b>	52 3/8"	30"	170	\$1635	+\$165
	<b>36-4LUE</b>	52 3/8"	36"	195	\$1888	+\$190
	<b>42-4LUE</b>	52 3/8"	42"	230	\$2144	+\$216

# 9900 Series Laterals

## Pre-configured

4 high

### How to order

1. Specify product number.
2. Specify finish color.
3. Specify options.

### Product code key example

#### 36-61.5-4EDPE

**36** cabinet width  
**61.5** interior height  
**4** number of drawers  
**EDP** EDP drawers  
**E** 9900 Series

### General information

All 13.5" and 15" openings for 14 7/8" x 11" EDP printouts include EDP kit for side-to-side filing of Accodata type 2 point suspension binders. Exterior cabinet heights are nominal. Actual heights (with glides fully recessed) are 1/8" less. Cabinets are priced inclusive 1 pair of hangfile bars in each pullout opening and fixed shelves are standard with 3 plate dividers.

**Cabinets are 18" in depth.**

### Counterweights

Counterweights are required for ALL freestanding units that are not anchored or ganged to other cabinets or bolted to walls/floor. See Counterweight matrix on page 023

### Accessories

See Lateral File Accessories section for counterweights and accessories.

### Lock option

Cabinets come standard with lock. If lock is not required add suffix '/NL' after product number. Deduct \$50 list.

### Finishes

Refer to Finishes section for color options. Drawer bodies and accessories are finished in Eco Black.

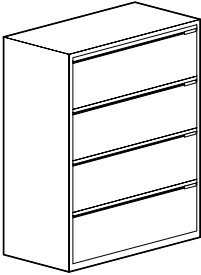
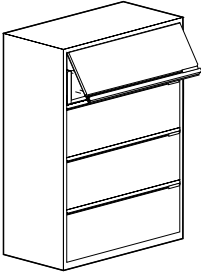
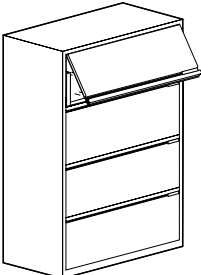
Description	Part number	Exterior height	Width	Weight (lbs)	9900 series/ Neutral paint	Accent paint
 <p>4 high cabinet 4-13.5" fixed front EDP drawers</p>	<b>30-54-4EDPE</b>	56 7/8"	30"	175	\$1933	+\$194
	<b>36-54-4EDPE</b>	56 7/8"	36"	220	\$2200	+\$222
	<b>42-54-4EDPE</b>	56 7/8"	42"	250	\$2463	+\$248
 <p>4 high cabinet 4 EDP drawers, top opening 15" lift-up with pullout shelf, other 3 openings 15" fixed front drawers</p>	<b>30-60-4EDPE</b>	62 7/8"	30"	195	\$1940	+\$195
	<b>36-60-4EDPE</b>	62 7/8"	36"	230	\$2213	+\$223
	<b>42-60-4EDPE</b>	62 7/8"	42"	260	\$2482	+\$250
 <p>4 high cabinet 4 EDP drawers, top opening 15" lift-up with pullout shelf, bottom 3 openings 15" fixed front drawers, 1.5" tie bar</p>	<b>30-61.5-4EDPE</b>	64 3/8"	30"	200	\$1942	+\$195
	<b>36-61.5-4EDPE</b>	64 3/8"	36"	235	\$2214	+\$223
	<b>42-61.5-4EDPE</b>	64 3/8"	42"	265	\$2483	+\$250

## How to order

1. Specify product number.
2. Specify finish color.
3. Specify options.

## Product code key example

### 36-52.5-5FFE

**36** cabinet width  
**52.5** interior height  
**5** number of drawers  
**FF** fixed front  
**E** 9900 Series

## General information

Exterior cabinet heights are nominal. Actual heights (with glides fully recessed) are 1/8" less. Cabinets are priced inclusive 1 pair of hangfile bars in each pullout opening and fixed shelves are standard with 3 plate dividers.

**Cabinets are 18" in depth.**

## Counterweights

Counterweights are required for ALL freestanding units that are not anchored or ganged to other cabinets or bolted to walls/floor. See Counterweight matrix on page 023.

## Accessories



See Lateral File Accessories section for counterweights and accessories.

## Lock option

Cabinets come standard with lock. If lock is not required add suffix '/NL' after product number. Deduct \$50 list.

## Finishes

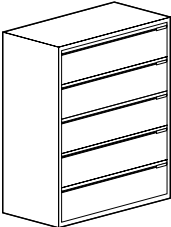
Refer to Finishes section for color options. Drawer bodies and accessories are finished in Eco Black.

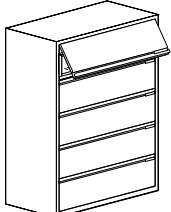
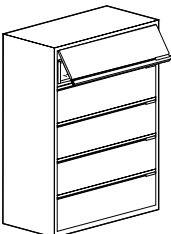
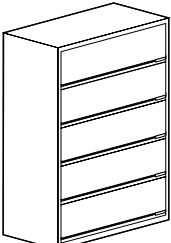
Description	Part number	Exterior height	Width	Weight (lbs)	9900 series/ Neutral paint	Accent paint	
	5 high cabinet	<b>30-52.5-5FFE</b>	55 3/8"	30"	180	\$1575	+\$192
	5-10.5" fixed front drawers	<b>36-52.5-5FFE</b>	55 3/8"	36"	205	\$1650	+\$221
		<b>42-52.5-5FFE</b>	55 3/8"	42"	240	\$1725	+\$250
	5 high cabinet	<b>30-54-5FFE</b>	56 7/8"	30"	185	\$1925	+\$193
	top opening 12" lift-up with	<b>36-54-5FFE</b>	56 7/8"	36"	210	\$2194	+\$221
	pullout shelf, other 4 openings	<b>42-54-5FFE</b>	56 7/8"	42"	245	\$2492	+\$251
	10.5" fixed front drawers						
	5 high cabinet	<b>30-55.5-5FFE</b>	58 3/8"	30"	185	\$1922	+\$193
	top opening 13.5" lift-up with	<b>36-55.5-5FFE</b>	58 3/8"	36"	210	\$2207	+\$222
	fixed shelf, other 4 openings	<b>42-55.5-5FFE</b>	58 3/8"	42"	245	\$2516	+\$253
	10.5" fixed front drawers						
	5 high cabinet	<b>30-60-5FFE</b>	62 7/8"	30"	195	\$1665	+\$194
	top opening 12" lift-up with	<b>36-60-5FFE</b>	62 7/8"	36"	230	\$1740	+\$223
	pullout shelf, other 4 openings	<b>42-60-5FFE</b>	62 7/8"	42"	260	\$1815	+\$253
	12" fixed front drawers						
	5 high cabinet	<b>30-60-5ETE</b>	62 7/8"	30"	195	\$1866	+\$188
	5-12" lift-up doors with fixed	<b>36-60-5ETE</b>	62 7/8"	36"	230	\$2120	+\$214
	shelves	<b>42-60-5ETE</b>	62 7/8"	42"	260	\$2426	+\$244

# 9900 Series Laterals

**Pre-configured**  
5 high

## How to order

1. Specify product number.
2. Specify finish color.
3. Specify options.

## Product code key example

**36-60-5LUE**

**36** cabinet width  
**60** interior height  
**5** number of doors  
**LU** lift-up door  
**E** 9900 Series

## General information

Exterior cabinet heights are nominal. Actual heights (with glides fully recessed) are  $\frac{1}{8}$ " less. Cabinets are priced inclusive 1 pair of hangfile bars in each pullout opening and fixed shelves are standard with 3 plate dividers.

**Cabinets are 18" in depth.**

## Counterweights

Counterweights are required for ALL freestanding units that are not anchored or ganged to other cabinets or bolted to walls/floor. See Counterweight matrix on page 023.

## Accessories

See Lateral File Accessories section for counterweights and accessories.

## Lock option

Cabinets come standard with lock. If lock is not required add suffix '/NL' after product number. Deduct \$50 list.

## Finishes

Refer to Finishes section for color options. Drawer bodies and accessories are finished in Eco Black.

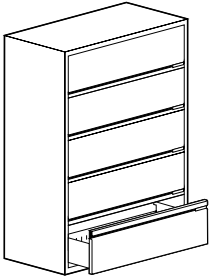
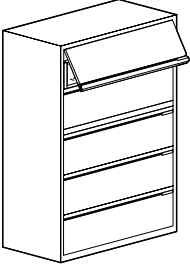
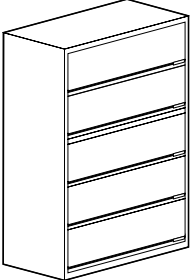
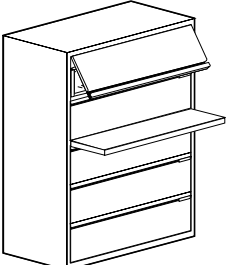
Description	Part number	Exterior height	Width	Weight (lbs)	9900 series/ Neutral paint	Accent paint
 <p>5 high cabinet 4-12" lift-up doors with pullout shelves, bottom opening 1-12" fixed front drawer</p>	<b>30-60-5LUE</b>	62 $\frac{7}{8}$ "	30"	195	\$1931	+\$194
	<b>36-60-5LUE</b>	62 $\frac{7}{8}$ "	36"	230	\$2210	+\$223
	<b>42-60-5LUE</b>	62 $\frac{7}{8}$ "	42"	260	\$2513	+\$253
 <p>5 high cabinet top opening 12" lift-up with pullout shelf, other 4 openings 12" fixed front drawers, 1.5" tie bar</p>	<b>30-5FFE</b>	64 $\frac{3}{8}$ "	30"	200	\$1670	+\$194
	<b>36-5FFE</b>	64 $\frac{3}{8}$ "	36"	235	\$1750	+\$223
	<b>42-5FFE</b>	64 $\frac{3}{8}$ "	42"	265	\$1825	+\$253
 <p>5 high cabinet 5-12" lift-up doors with fixed shelves, 1.5" tie bar</p>	<b>30-5ETE</b>	64 $\frac{3}{8}$ "	30"	200	\$1867	+\$188
	<b>36-5ETE</b>	64 $\frac{3}{8}$ "	36"	235	\$2122	+\$214
	<b>42-5ETE</b>	64 $\frac{3}{8}$ "	42"	265	\$2427	+\$245
 <p>5 high cabinet top opening 12" lift-up with pullout shelf, other 4 openings 12" fixed front drawers, 1.5" reference shelf</p>	<b>30-5FFE-RF</b>	64 $\frac{3}{8}$ "	30"	200	\$1795	+\$206
	<b>36-5FFE-RF</b>	64 $\frac{3}{8}$ "	36"	235	\$1880	+\$235
	<b>42-5FFE-RF</b>	64 $\frac{3}{8}$ "	42"	265	\$2010	+\$265

### How to order

1. Specify product number.
2. Specify finish color.
3. Specify options.

### Product code key example

#### 36-61.5-LU4FFE

- 36** cabinet width  
**61.5** interior height  
**LU** lift-up door  
**4** number of drawers  
**FF** fixed front  
**E** 9900 Series

### General information

All 13.5" and 15" openings for 14 7/8" x 11" EDP printouts include EDP kit for side-to-side filing of Accodata type 2 point suspension binders. Exterior cabinet heights are nominal. Actual heights (with glides fully recessed) are 1/8" less. Cabinets are priced inclusive 1 pair of hangfile bars in each pullout opening and fixed shelves are standard with 3 plate dividers.

**Cabinets are 18" in depth.**

### Counterweights

Counterweights are required for ALL freestanding units that are not anchored or ganged to other cabinets or bolted to walls/floor. See Counterweight matrix on page 023

### Accessories

See Lateral File Accessories section for counterweights and accessories.

### Lock option

Cabinets come standard with lock. If lock is not required add suffix '/NLT' after product number. Deduct \$50 list.

### Finishes

Refer to Finishes section for color options. Drawer bodies and accessories are finished in Eco Black.

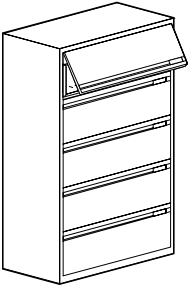
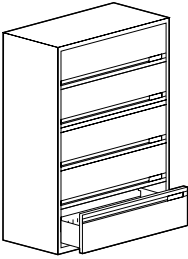
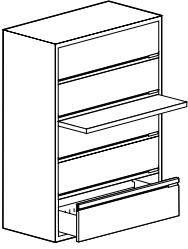
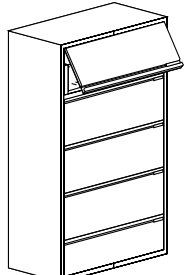
Description	Part number	Exterior height	Width	Weight (lbs)	9900 series/ Neutral paint	Accent paint
 <p>5 high cabinet top opening 13.5" liftup with fixed shelf and 3 plate dividers, other 4 openings 12" fixed front drawers.</p>	<b>30-615-LU4FFE</b>	64 3/8"	30"	200	\$1850	+\$194
	<b>36-615-LU4FFE</b>	64 3/8"	36"	235	\$1900	+\$223
	<b>42-615-LU4FFE</b>	64 3/8"	42"	265	\$2100	+\$254
 <p>5 high cabinet 4-12" lift-up doors with pullout shelves, bottom opening 1-12" fixed front drawer, 1.5" tie bar</p>	<b>30-5LUE</b>	64 3/8"	30"	200	\$1933	+\$194
	<b>36-5LUE</b>	64 3/8"	36"	235	\$2211	+\$223
	<b>42-5LUE</b>	64 3/8"	42"	265	\$2514	+\$253
 <p>5 high cabinet 4-12", lift-up doors with pullout shelves, bottom opening 1-12" fixed front drawer, 1.5" reference shelf</p>	<b>30-5LUE-RF</b>	64 3/8"	30"	200	\$2056	+\$206
	<b>36-5LUE-RF</b>	64 3/8"	36"	235	\$2337	+\$235
	<b>42-5LUE-RF</b>	64 3/8"	42"	265	\$2640	+\$265
 <p>5 high cabinet 5 EDP drawers, top opening 15" lift-up with pullout shelf, other 4 openings 13.5" fixed front EDP drawers, 1.5" tie bar</p>	<b>30-70.5-5EDPE</b>	73 3/8"	30"	210	\$2395	+\$240
	<b>36-70.5-5EDPE</b>	73 3/8"	36"	245	\$2734	+\$274
	<b>42-70.5-5EDPE</b>	73 3/8"	42"	275	\$3035	+\$305



# 9900 Series Laterals

**Pre-configured**  
6 high

## How to order

1. Specify product number.
2. Specify finish color.
3. Specify options.

## Product code key example

**36-45-6B7E**

**36** cabinet width  
**45** interior height  
**6** number of drawers  
**B7** 7 1/2" box drawer  
**E** 9900 Series

## General information

Exterior cabinet heights are nominal. Actual heights (with glides fully recessed) are 1/8" less. Cabinets are priced inclusive of 1 pair of hangfile bars in each pullout opening and fixed shelves are standard with 3 plate dividers. 7.5" box drawers come with 3 dividers in 30" wide drawers, 4 dividers in 36" wide drawers and 5 dividers in 42" wide drawers.

**Cabinets are 18" in depth.**

## Number of CD's per drawer width

	No. of rows	Regular	Slimline
30" wide	4	140	276
36" wide	5	175	345
42" wide	6	210	414

## Counterweights

Counterweights are required for ALL freestanding units that are not anchored or ganged to other cabinets or bolted to walls/floor. See Counterweight matrix on page 023.

## Accessories

See Lateral File Accessories section for counterweights and accessories.

## Lock option

Cabinets come standard with lock. If lock is not required add suffix '/NL' after product number. Deduct \$50 list.

## Finishes

Refer to Finishes section for color options. Drawer bodies and accessories are finished in Eco Black.

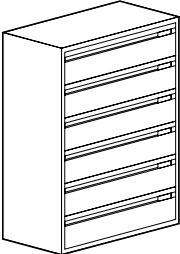
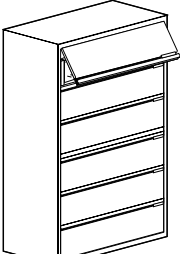
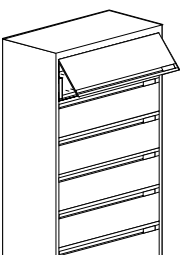
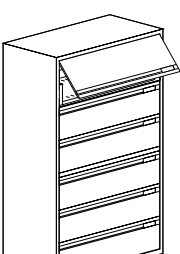
Description	Part number	Exterior height	Width	Weight (lbs)	9900 series/ Neutral paint	Accent paint
 <p>6 high cabinet 6-7.5" drawers with accessories</p>	<b>30-45-6B7E</b>	47 7/8"	30"	154	\$2229	+\$225
	<b>36-45-6B7E</b>	47 7/8"	36"	197	\$2602	+\$261
	<b>42-45-6B7E</b>	47 7/8"	42"	223	\$2996	+\$301
 <p>6 high cabinet top opening 12" lift-up with pullout shelf, other 5 openings 10.5" fixed front drawers, 1.5" tie bar</p>	<b>30-66-6FFE</b>	64 7/8"	30"	215	\$2251	+\$227
	<b>36-66-6FFE</b>	64 7/8"	36"	230	\$2577	+\$259
	<b>42-66-6FFE</b>	64 7/8"	42"	260	\$2908	+\$293
 <p>6 high cabinet top opening 13.5" lift-up with fixed shelf, other 5 openings 10.5" fixed front drawers</p>	<b>30-66-LU5F10E</b>	68 7/8"	30"	215	\$2247	+\$226
	<b>36-66-LU5F10E</b>	68 7/8"	36"	230	\$2586	+\$260
	<b>42-66-LU5F10E</b>	68 7/8"	42"	260	\$2921	+\$294
 <p>6 high cabinet top opening 13.5" liftup with fixed shelf and 3 plate dividers, other 5 openings 10.5" fixed front drawers, 1.5" tie bar</p>	<b>30-67.5-6FFE</b>	70 3/8"	30"	245	\$2272	+\$229
	<b>36-67.5-6FFE</b>	70 3/8"	36"	265	\$2605	+\$262
	<b>42-67.5-6FFE</b>	70 3/8"	42"	285	\$2947	+\$296

## How to order

1. Specify product number.
2. Specify finish color.
3. Specify options.

## Product code key example

### 30-70.5-2LU4F10E

**30** cabinet width  
**70.5** interior height  
**2LU** number of lift-up doors  
**4** number of drawers  
**F10** 10.5" h file drawers  
**E** 9900 Series

## General information

Exterior cabinet heights are nominal. Actual heights (with glides fully recessed) are 1/8" less. Cabinets are priced inclusive 1 pair of hangfile bars in each pullout opening and fixed shelves are standard with 3 plate dividers.

**Cabinets are 18" in depth.**

## Counterweights

Counterweights are required for ALL freestanding units that are not anchored or ganged to other cabinets or bolted to walls/floor. See Counterweight matrix on page 023.

## Accessories

See Lateral File Accessories section for counterweights and accessories.

## Lock option

Cabinets come standard with lock. If lock is not required add suffix '/NL' after product number. Deduct \$50 list.

## Finishes

Refer to Finishes section for color options. Drawer bodies and accessories are finished in Eco Black.

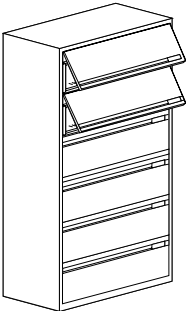
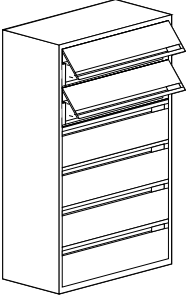
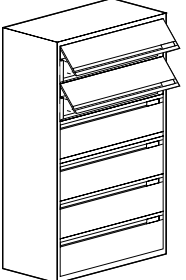
Description	Part number	Exterior height	Width	Weight (lbs)	9900 series/ Neutral paint	Accent paint
 <p>6 high cabinet                      top 2 openings 13.5" lift-up                      with fixed shelf and 3 plate                      dividers, other 4 openings                      10.5" fixed front drawers, 1.5"                      tie bar</p>	<b>30-705-2LU4F10E</b>	73 3/8"	30"	232	\$2312	+\$232
	<b>36-705-2LU4F10E</b>	73 3/8"	36"	260	\$2666	+\$267
	<b>42-705-2LU4F10E</b>	73 3/8"	42"	302	\$3016	+\$303
 <p>6 high cabinet                      top opening 12" lift-up                      with fixed shelf and 3 plate                      dividers, next opening 12"                      lift-up with pullout shelf                      and hangfile bars, other                      4 openings 12" fixed front                      doors</p>	<b>30-72-6FFE</b>	74 7/8"	30"	250	\$2337	+\$235
	<b>36-72-6FFE</b>	74 7/8"	36"	270	\$2670	+\$268
	<b>42-72-6FFE</b>	74 7/8"	42"	291	\$3062	+\$307
 <p>6 high cabinet                      top opening 12" lift-up                      with fixed shelf and 3 plate                      dividers, next opening 12"                      lift-up with pullout shelf                      and hangfile bars, other 4                      openings 12" fixed front                      drawers, 1.5" tie bar</p>	<b>30-6FFE</b>	76 3/8"	30"	250	\$2354	+\$237
	<b>36-6FFE</b>	76 3/8"	36"	270	\$2691	+\$270
	<b>42-6FFE</b>	76 3/8"	42"	291	\$3033	+\$304

# 9900 Series Laterals

**Pre-configured**  
6 high

## How to order

1. Specify product number.
2. Specify finish color.
3. Specify options.

## Product code key example

**36-6FFE-RF**

v

## General information

Exterior cabinet heights are nominal. Actual heights (with glides fully recessed) are  $\frac{1}{8}$ " less. Cabinets are priced inclusive 1 pair of hangfile bars in each pullout opening and fixed shelves are standard with 3 plate dividers.

**Cabinets are 18" in depth.**

## Counterweights

Counterweights are required for ALL freestanding units that are not anchored or ganged to other cabinets or bolted to walls/floor. See Counterweight matrix on page 023.

## Accessories

See Lateral File Accessories section for counterweights and accessories.

## Lock option

Cabinets come standard with lock. If lock is not required add suffix '/NL' after product number. Deduct \$50 list.

## Finishes

Refer to Finishes section for color options. Drawer bodies and accessories are finished in Eco Black.

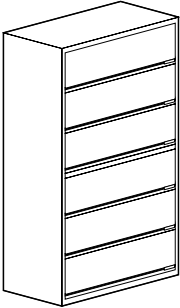
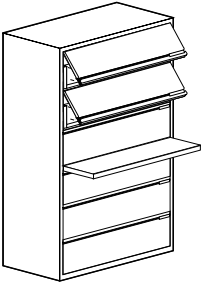
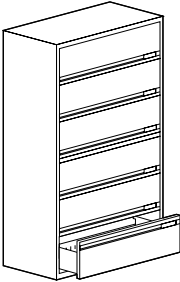
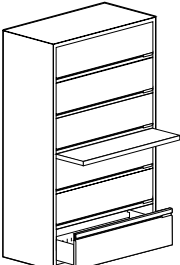
Description	Part number	Exterior height	Width	Weight (lbs)	9900 series/ Neutral paint	Accent paint
 <p>6 high cabinet 6-12" lift-up doors with fixed shelves, 1.5" tie bar</p>	<b>30-6ETE</b>	76 $\frac{3}{8}$ "	30"	250	\$2289	+\$230
	<b>36-6ETE</b>	76 $\frac{3}{8}$ "	36"	270	\$2601	+\$261
	<b>42-6ETE</b>	76 $\frac{3}{8}$ "	42"	291	\$2950	+\$297
 <p>6 high cabinet top opening 12" lift-up with fixed shelf and 3 plate dividers, next opening 12" lift-up with pullout shelf and hangfile bars, other 4 openings 12" fixed front drawers, 1.5" reference shelf</p>	<b>30-6FFE-RF</b>	76 $\frac{3}{8}$ "	30"	250	\$2478	+\$249
	<b>36-6FFE-RF</b>	76 $\frac{3}{8}$ "	36"	270	\$2819	+\$284
	<b>42-6FFE-RF</b>	76 $\frac{3}{8}$ "	42"	291	\$3162	+\$318
 <p>6 high cabinet top opening 12" lift-up door with fixed shelf and 3 plate dividers, other 4 openings 12" lift-up doors with pullout shelves, bottom opening 12" fixed front drawer, 1.5" tie bar</p>	<b>30-6LUE</b>	76 $\frac{3}{8}$ "	30"	250	\$2354	+\$237
	<b>36-6LUE</b>	76 $\frac{3}{8}$ "	36"	270	\$2691	+\$270
	<b>42-6LUE</b>	76 $\frac{3}{8}$ "	42"	291	\$3033	+\$304
 <p>6 high cabinet top opening 12" lift-up door with fixed shelf and 3 plate dividers, other 4 openings 12" lift-up doors with pullout shelves, bottom opening 12" fixed front drawer, 1.5" reference shelf</p>	<b>30-6LUE-RF</b>	76 $\frac{3}{8}$ "	30"	250	\$2478	+\$249
	<b>36-6LUE-RF</b>	76 $\frac{3}{8}$ "	36"	270	\$2819	+\$284
	<b>42-6LUE-RF</b>	76 $\frac{3}{8}$ "	42"	291	\$3162	+\$318

### How to order

1. Specify product number.
2. Specify finish color.
3. Specify options.

### Product code key example

**36-75-6FFE**

- 36** cabinet width
- 75** interior height
- 6** number of drawers
- FF** fixed front
- E** 9900 Series

### General information

Exterior cabinet heights are nominal. Actual heights (with glides fully recessed) are 1/8" less. Cabinets are priced inclusive 1 pair of hangfile bars in each pullout opening and fixed shelves are standard with 3 plate dividers.

**Cabinets are 18" in depth.**

### Counterweights

Counterweights are required for ALL freestanding units that are not anchored or ganged to other cabinets or bolted to walls/floor. See Counterweight matrix on page 023

### Accessories

See Lateral File Accessories section for counterweights and accessories.

### Lock option

Cabinets come standard with lock. If lock is not required add suffix '/NL' after product number. Deduct \$50 list.

### Finishes

Refer to Finishes section for color options. Drawer bodies and accessories are finished in Eco Black.

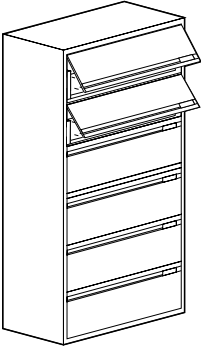
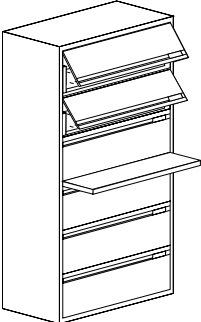
Description	Part number	Exterior height	Width	Weight (lbs)	9900 series/ Neutral paint	Accent paint
 <p>6 high cabinet top opening 13.5" lift-up with fixed shelf and 3 plate dividers, next opening 12" lift-up with pullout shelf and hangfile bars, other 4 openings 12" fixed front drawers, 1.5" tie bar</p>	<b>30-75-6FFE</b>	77 7/8"	30"	257	\$2398	+\$242
	<b>36-75-6FFE</b>	77 7/8"	36"	277	\$2745	+\$276
	<b>42-75-6FFE</b>	77 7/8"	42"	299	\$3090	+\$311
 <p>6 high cabinet top opening 13.5" liftup with fixed shelf and 3 plate dividers, next opening 12" lift-up with pullout shelf and hangfile bars, other 4 openings 12" fixed front drawers, 1.5" reference shelf</p>	<b>30-75-6FFE-RF</b>	77 7/8"	30"	257	\$2522	+\$254
	<b>36-75-6FFE-RF</b>	77 7/8"	36"	277	\$2871	+\$289
	<b>42-75-6FFE-RF</b>	77 7/8"	42"	299	\$3220	+\$323

# 9900 Series Laterals

## Pre-configured

7 high

### How to order

1. Specify product number.
2. Specify finish color.
3. Specify options.

### Product code key example

**36-52.5-7B7E**

**36** cabinet width  
**52.5** interior height  
**7** number of drawers  
**B7** 7.5" box drawer  
**E** 9900 Series

### General information

Exterior cabinet heights are nominal. Actual heights (with glides fully recessed) are  $\frac{1}{8}$ " less. Cabinets are priced inclusive of 1 pair of hangfile bars in each pullout opening and fixed shelves are standard with 3 plate dividers. 7.5" box drawers come with 3 dividers in 30" wide drawers, 4 dividers in 36" wide drawers and 5 dividers in 42" wide drawers.

**Cabinets are 18" in depth.**

### Number of CD's per drawer width

	No. of rows	Regular	Slimline
30" wide	4	140	276
36" wide	5	175	345
42" wide	6	210	414

### Counterweights

Counterweights are required for ALL freestanding units that are not anchored or ganged to other cabinets or bolted to walls/floor. See Counterweight matrix on page 023

### Lock option

Cabinets come standard with lock. If lock is not required add suffix '**/NL**' after product number. Deduct \$50 list.

### Finishes

Refer to Finishes section for color options. Drawer bodies and accessories are finished in Eco Black.

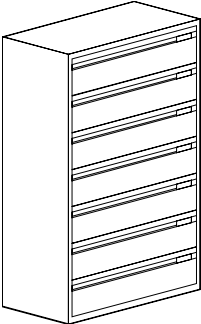
Description	Part number	Exterior height	Width	Weight (lbs)	9900 series/ Neutral paint	Accent paint
 7 high cabinet 7- 7.5" drawers with accessories	<b>30-52.5-7B7E</b>	55 $\frac{3}{8}$ "	30"	170	\$2540	+\$255
	<b>36-52.5-7B7E</b>	55 $\frac{3}{8}$ "	36"	219	\$2931	+\$295
	<b>42-52.5-7B7E</b>	55 $\frac{3}{8}$ "	42"	247	\$3377	+\$338

### How to order

1. Specify product number.
2. Specify finish color.
3. Specify options.

### Product code key example

#### 36-60-8B7E

- 36** cabinet width
- 60** interior height
- 8** number of drawers
- B7** 7.5" box drawer
- E** 9900 Series

### General information

Exterior cabinet heights are nominal. Actual heights (with glides fully recessed) are 1/8" less. Cabinets are priced inclusive of 1 pair of hangfile bars in each pullout opening and fixed shelves are standard with 3 plate dividers. 7.5" box drawers come with 3 dividers in 30" wide drawers, 4 dividers in 36" wide drawers and 5 dividers in 42" wide drawers.

#### Cabinets are 18" in depth.

#### Number of CD's per drawer width

	No. of rows	Regular	Slimline
30" wide	4	140	276
36" wide	5	175	345
42" wide	6	210	414

### Counterweights

Counterweights are required for ALL freestanding units that are not anchored or ganged to other cabinets or bolted to walls/floor. See Counterweight matrix on page 023

### Lock option

Cabinets come standard with lock. If lock is not required add suffix '/NL' after product number. Deduct \$50 list.

### Finishes

Refer to Finishes section for color options. Drawer bodies and accessories are finished in Eco Black.

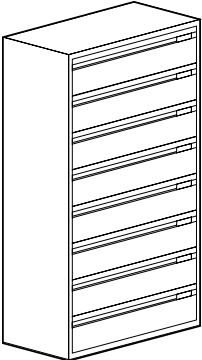
Description	Part number	Exterior height	Width	Weight (lbs)	9900 series/ Neutral paint	Accent paint
 8 high cabinet	<b>30-60-8B7E</b>	62 7/8"	30"	186	\$2834	+\$285
	<b>36-60-8B7E</b>	62 7/8"	36"	241	\$3266	+\$328
	<b>42-60-8B7E</b>	62 7/8"	42"	271	\$3760	+\$377
8- 7.5" drawers with accessories						

# 9900 Series Laterals

## Pre-configured Individually Locking

### How to order

1. Specify product number.
2. Specify finish color.
3. Specify options.

### Product code key example

**36225-2FFE1TB**

- 36** cabinet width  
**225** interior height  
**2** number of drawers  
**FF** fixed front  
**E** 9900 Series  
**1TB** number of locking tier bars

### General information

Exterior cabinet heights are nominal. Actual heights (with glides fully recessed) are 1/8" less. Cabinets are priced inclusive 1 pair of hangfile bars in each pullout opening and fixed shelves are standard with 3 plate dividers.

**Cabinets are 18" in depth.**

### Counterweights

Counterweights are required for ALL freestanding units that are not anchored or ganged to other cabinets or bolted to walls/floor. See Counterweight matrix on page 023.

### Accessories

See Lateral File Accessories section for counterweights and accessories.

### Lock option

Individually locking drawers.

### Finishes

Refer to Finishes section for color options. Drawer bodies and accessories are finished in Eco Black.

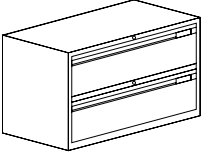
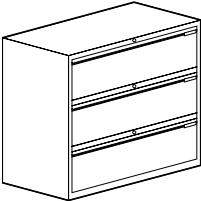
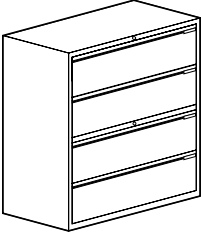
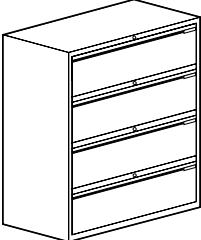
Description	Part number	Exterior height	Width	Weight (lbs)	9900 series/ Neutral paint	Accent paint
 <p>2 high cabinet 2-10.5" fixed front individually locking drawers</p>	<b>30225-2FFE1TB</b>	25 3/8"	30"	90	\$1114	+\$113
	<b>36225-2FFE1TB</b>	25 3/8"	36"	105	\$1239	+\$125
	<b>42225-2FFE1TB</b>	25 3/8"	42"	120	\$1339	+\$134
 <p>3 high cabinet 3-10.5" fixed front individually locking drawers</p>	<b>30345-3FFE2TB</b>	37 3/8"	30"	130	\$1626	+\$164
	<b>36345-3FFE2TB</b>	37 3/8"	36"	150	\$1785	+\$180
	<b>42345-3FFE2TB</b>	37 3/8"	42"	170	\$1959	+\$197
 <p>4 high cabinet 4-10.5" fixed front drawers. Top two drawers share one lock, bottom two drawers share another lock.</p>	<b>30435-4FFE1TB</b>	46 3/8"	30"	145	\$1754	+\$177
	<b>36435-4FFE1TB</b>	46 3/8"	36"	165	\$2006	+\$201
	<b>42435-4FFE1TB</b>	46 3/8"	42"	185	\$2252	+\$227
 <p>4 high cabinet 4-10.5" fixed front individually locking drawers</p>	<b>30465-4FFE3TB</b>	49 3/8"	30"	180	\$2126	+\$215
	<b>36465-4FFE3TB</b>	49 3/8"	36"	205	\$2388	+\$240
	<b>42465-4FFE3TB</b>	49 3/8"	42"	240	\$2637	+\$265

# 9900 Series Laterals

**Pre-configured**  
Individually Locking

## How to order

1. Specify product number.
2. Specify finish color.
3. Specify options.

## Product code key example

### 3660-5FFE4TB

- 36** cabinet width  
**60** interior height  
**5** number of drawers  
**FF** fixed front  
**E** 9900 Series  
**4TB** number of locking tier bars

## General information

Exterior cabinet heights are nominal. Actual heights (with glides fully recessed) are 1/8" less. Cabinets are priced inclusive 1 pair of hangfile bars in each pullout opening and fixed shelves are standard with 3 plate dividers.

**Cabinets are 18" in depth.**

## Counterweights

Counterweights are required for ALL freestanding units that are not anchored or ganged to other cabinets or bolted to walls/floor. See Counterweight matrix on page 023.

## Accessories

See Lateral File Accessories section for counterweights and accessories.

## Lock option

Individually locking drawers.

## Finishes

Refer to Finishes section for color options. Drawer bodies and accessories are finished in Eco Black.

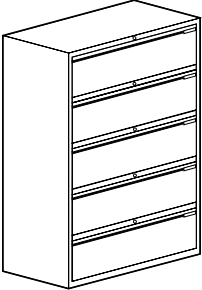
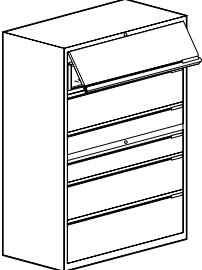
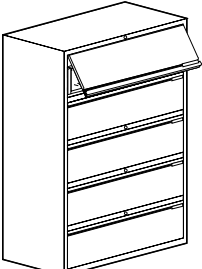
Description	Part number	Exterior height	Width	Weight (lbs)	9900 series/ Neutral paint	Accent paint
 <p>5 high cabinet 5-10.5" fixed front individually locking drawers</p>	<b>30585-5FFE4TB</b>	61 3/8"	30"	195	\$2620	+\$263
	<b>36585-5FFE4TB</b>	61 3/8"	36"	230	\$2886	+\$290
	<b>42585-5FFE4TB</b>	61 3/8"	42"	260	\$3177	+\$319
 <p>Cabinet from top to bottom: 1-12" lift-up door with pullout shelf, 1-10.5" fixed front drawer, 2-6" fixed front drawers, 10.5" fixed front drawer and 1-12" fixed front drawer. Each bank of 3 drawers locks individually.</p>	<b>305812LU5FFETB</b>	61 3/8"	30"	235	\$2261	+\$228
	<b>365812LU5FFETB</b>	61 3/8"	36"	240	\$2548	+\$256
	<b>425812LU5FFETB</b>	61 3/8"	42"	270	\$2852	+\$287
 <p>5 high cabinet top opening 12" lift-up with pullout shelf, other 4 openings 10 1/2" fixed front individually locking drawers</p>	<b>3060-5FFE4TB</b>	62 7/8"	30"	195	\$2620	+\$263
	<b>3660-5FFE4TB</b>	62 7/8"	36"	230	\$2886	+\$290
	<b>4260-5FFE4TB</b>	62 7/8"	42"	260	\$3177	+\$319



# 9900 Series Laterals

## Pre-configured Secure Files

### How to order

1. Specify product number.
2. Specify finish color.
3. Specify options.

### Product code key example

#### 36-2FFE-SB

- 36** cabinet width  
**2** number of drawers  
**FF** fixed front  
**E** 9900 Series  
**SB** sliding security bar

### General information

Exterior cabinet heights are nominal. Actual heights (with glides fully recessed) are 1/8" less. Cabinets come with piano style hinges, a 1 1/2" sliding security bar and a lock hook with double sided tape. Cabinets are priced inclusive 1 pair of hangfile bars in each pullout opening.

**Cabinets are 18" in depth.**

### Counterweights

Counterweights are required for ALL freestanding units that are not anchored or ganged to other cabinets or bolted to walls/floor. See Counterweight matrix on page 023.

### Accessories

See Lateral File Accessories section for counterweights and accessories.

### Lock option

Cabinets come standard with lock. If lock is not required add suffix '/NL' after product number. Deduct \$50 list.

### Finishes

Refer to Finishes section for color options. Drawer bodies and accessories are finished in Eco Black.

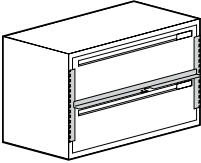
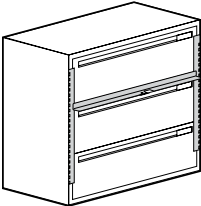
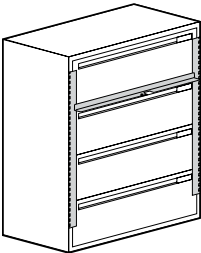
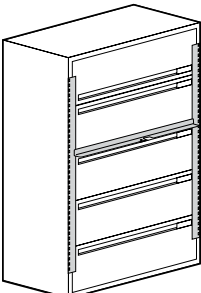
Description	Part number	Exterior height	Width	Weight (lbs)	9900 series/ Neutral paint	Accent paint
 <p>2 high cabinet 2-12" fixed front drawers, 1.5" sliding security bar</p>	<b>30-2FvFE-SB</b>	28 3/8"	30"	107	\$1300	+\$131
	<b>36-2FFE-SB</b>	28 3/8"	36"	127	\$1365	+\$137
	<b>42-2FFE-SB</b>	28 3/8"	42"	138	\$1479	+\$150
 <p>3 high cabinet 3-12" fixed front drawers, 1.5" sliding security bar</p>	<b>30-3FFE-SB</b>	40 3/8"	30"	139	\$1639	+\$165
	<b>36-3FFE-SB</b>	40 3/8"	36"	159	\$1784	+\$180
	<b>42-3FFE-SB</b>	40 3/8"	42"	181	\$1974	+\$198
 <p>4 high cabinet 4-12" fixed front drawers, 1.5" sliding security bar</p>	<b>30-4FFE-SB</b>	52 3/8"	30"	180	\$1970	+\$198
	<b>36-4FFE-SB</b>	52 3/8"	36"	205	\$2222	+\$224
	<b>42-4FFE-SB</b>	52 3/8"	42"	241	\$2480	+\$250
 <p>5 high cabinet top opening 12" lift-up with pullout shelf, other 4 openings 12" fixed front drawers, 1.5" sliding security bar</p>	<b>30-5FFE-SB</b>	64 3/8"	30"	212	\$2292	+\$231
	<b>36-5FFE-SB</b>	64 3/8"	36"	247	\$2571	+\$258
	<b>42-5FFE-SB</b>	64 3/8"	42"	274	\$2873	+\$289

## How to order

1. Specify product number.
2. Specify finish color.
3. Specify options.

## Product code key example

### 3624E-F-R2B

**36** cabinet width  
**24** interior height  
**E** 9900 Series  
**F** 12" file drawer  
**R** right side  
**2B** 6" box drawers

## General information

Exterior cabinet heights are nominal. Actual heights (with glides fully recessed) are 1/8" less. Cabinets are priced inclusive 1 pair of hangfile bars in each pullout opening and fixed shelves are standard with 3 plate dividers.

**Cabinets are 18" in depth.**

## Counterweights

Counterweights are required for ALL freestanding units that are not anchored or ganged to other cabinets or bolted to walls/floor. See Counterweight matrix on page 023.

## Accessories

See Lateral File Accessories section for counterweights and accessories.

## Lock option

Cabinets come standard with lock. If lock is not required add suffix '/NL' after product number. Deduct \$50 list.

## Finishes

Refer to Finishes section for color options. Drawer bodies and accessories are finished in Eco Black.

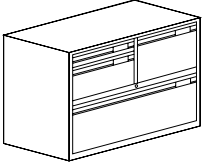
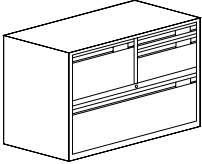
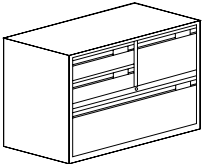
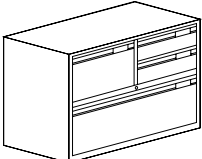
Description	Part number	Exterior height	Width	Weight (lbs)	9900 series/ Neutral paint	Accent paint
 <p>1-10.5" h x 15" w file drawer            1-3" h x 15" w pencil drawer            1-7.5" h x 15" w box drawer            1-10.5" h x 30" W file drawer            Counterweight included            Left hand unit must be specified under worksurface</p>	<b>30225E-F10LPB7</b>	25 3/8"	30"	117	\$1276	+\$128
 <p>1-10.5" h x 15" w file drawer            1-3" h x 15" w pencil drawer            1-7.5" h x 15" w box drawer            1-10.5" h x 30" W file drawer            Counterweight included</p>	<b>30225E-F10RPB7</b>	25 3/8"	30"	117	\$1276	+\$128
 <p>1-12" h x 15" w file drawer            2-6" h x 15" w box drawers            1-10.5" h x 30" w file drawer            Counterweight included            Left hand unit must be specified under worksurface</p>	<b>3024E-F-L2B</b>	26 7/8"	30"	117	\$1294	+\$130
 <p>1-12" h x 15" w file drawer            2-6" h x 15" w box drawers            1-10.5" h x 30" w file drawer            Counterweight included</p>	<b>3024E-F-R2B</b>	26 7/8"	30"	117	\$1514	+\$130

# 9900 Series Laterals

## Pre-configured Multi-units

### How to order

1. Specify product number.
2. Specify finish color.
3. Specify options.

### Product code key example

#### 36-48-HD2FE

- 36** cabinet width  
**48** interior height  
**HD** hinged door  
**2** number of drawers  
**F** 12" file drawer  
**E** 9900 Series

### General information

Exterior cabinet heights are nominal. Actual heights (with glides fully recessed) are 1/8" less. Cabinets are priced inclusive 1 pair of hangfile bars in each pullout opening. Hinged doors are standard with self-closing European style hinges that open 110°. Shelves are slotted every 1 1/2" and are height adjustable in 1 1/2" increments. Shelf dividers are not included.

**Cabinets are 18" in depth.**

### Counterweights

Counterweights are required for ALL freestanding units that are not anchored or ganged to other cabinets or bolted to walls/floor. See Counterweight matrix on page 023.

### Accessories

See Lateral File Accessories section for counterweights and accessories.

### Lock option

Cabinets come standard with lock. If lock is not required add suffix '/NL' after product number. Deduct \$50 list.

### Finishes

Refer to Finishes section for color options. Drawer bodies and accessories are finished in Eco Black.

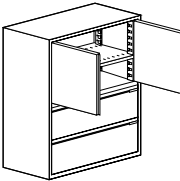
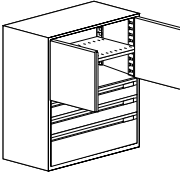
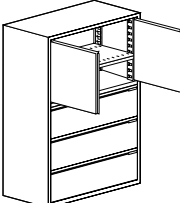
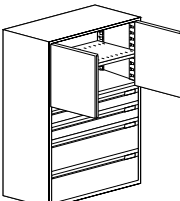
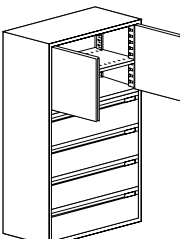
Description	Part number	Exterior height	Width	Weight (lbs)	9900 series/ Neutral paint	Accent paint
	<b>4 high cabinet</b>	50 7/8"	30"	170	\$1605	+\$162
	<b>top opening 24" hinged door</b>	50 7/8"	36"	195	\$1843	+\$186
	<b>cupboard insert with 1 adjustable slotted shelf, other 2 openings 12" fixed front drawers</b>	50 7/8"	42"	230	\$2075	+\$209
	<b>4 high cabinet</b>	50 7/8"	30"	175	\$1745	+\$176
	<b>Cabinet with top opening 24" hinged door cupboard insert with 1 adjustable slotted shelf, next 2 openings 6" fixed front drawers, bottom opening 12" fixed front drawer</b>	50 7/8"	36"	200	\$2000	+\$201
		50 7/8"	42"	235	\$2251	+\$227
	<b>5 high cabinet</b>	62 7/8"	30"	195	\$1913	+\$192
	<b>top opening 24" hinged door cupboard insert with 1 adjustable slotted shelf, other 3 openings 12" fixed front drawers</b>	62 7/8"	36"	230	\$2169	+\$219
		62 7/8"	42"	260	\$2444	+\$246
	<b>5 high cabinet</b>	62 7/8"	30"	195	\$2055	+\$206
	<b>top opening 24" hinged door cupboard insert with 1 adjustable slotted shelf, next 2 openings 6" fixed front drawers, bottom 2 openings 12" fixed front drawers</b>	62 7/8"	36"	230	\$2323	+\$234
		62 7/8"	42"	260	\$2617	+\$263
	<b>6 high cabinet</b>	74 7/8"	30"	250	\$2329	+\$234
	<b>top opening 24" hinged door cupboard insert with 1 adjustable slotted shelf, other 4 openings 12" fixed front drawers</b>	74 7/8"	36"	270	\$2639	+\$265
		74 7/8"	42"	291	\$2947	+\$296

## How to order

1. Specify product number.
2. Specify finish color.
3. Specify options.

## Product code key example

### 36-49.5-HDF10FE

- 36** cabinet width  
**49.5** interior height  
**HD** hinged door  
**F10** 10½" file drawer  
**F** 12" file drawer  
**E** 9900 Series

## General information

Exterior cabinet heights are nominal. Actual heights (with glides fully recessed) are ⅛" less. Cabinets are priced inclusive 1 pair of hangfile bars in each pullout opening. Hinged doors are standard with self-closing European style hinges that open 110°. Shelves are slotted every 1 ½" and are height adjustable in 1 ½" increments. Shelf dividers are not included.

**Cabinets are 18" in depth.**

## Counterweights

Counterweights are required for ALL freestanding units that are not anchored or ganged to other cabinets or bolted to walls/floor. See Counterweight matrix on page 023.

## Accessories

See Lateral File Accessories section for counterweights and accessories.

## Lock option

Cabinets come standard with lock. If lock is not required add suffix '/NL' after product number. Deduct \$50 list.

## Finishes

Refer to Finishes section for color options. Drawer bodies and accessories are finished in Eco Black.

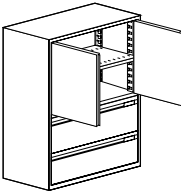
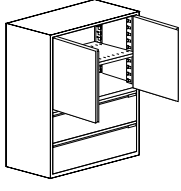
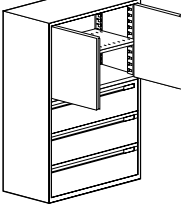
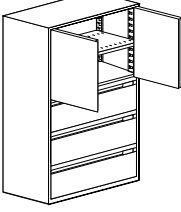
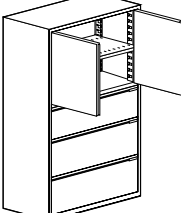
Description	Part number	Exterior height	Width	Weight (lbs)	9900 series/ Neutral paint	Accent paint
 <p><b>4 high cabinet</b>  <b>top opening 27" hinged door</b>  <b>cupboard insert with 1 adjustable slotted shelf, next opening 10.5" fixed front drawer, other opening 12" fixed front drawer.</b></p>	<b>3049.5-HDF10FE</b>	52 ⅜"	30"	170	\$1619	+\$163
	<b>3649.5-HDF10FE</b>	52 ⅜"	36"	195	\$1844	+\$186
	<b>4249.5-HDF10FE</b>	52 ⅜"	42"	230	\$2076	+\$209
 <p><b>4 high cabinet</b>  <b>top opening 27" hinged door</b>  <b>cupboard insert with 1 adjustable slotted shelf, other 2 openings 12" fixed front drawers, 1.5" tie bar</b></p>	<b>30525HD2FE</b>	55 ⅜"	30"	170	\$1635	+\$165
	<b>36525HD2FE</b>	55 ⅜"	36"	195	\$1852	+\$187
	<b>42525HD2FE</b>	55 ⅜"	42"	230	\$2094	+\$212
 <p><b>5 high cabinet</b>  <b>top opening 27" hinged door</b>  <b>cupboard insert with 1 adjustable slotted shelf, other 3 openings 10.5" fixed front drawers</b></p>	<b>3058.5-HD3F10E</b>	61 ⅜"	30"	195	\$1911	+\$192
	<b>3658.5-HD3F10E</b>	61 ⅜"	36"	230	\$2167	+\$219
	<b>4258.5-HD3F10E</b>	61 ⅜"	42"	260	\$2443	+\$246
 <p><b>5 high cabinet</b>  <b>top opening 27" hinged door</b>  <b>cupboard insert with 1 adjustable slotted shelf, 2-10.5" fixed front drawers and 1-12" fixed front drawer</b></p>	<b>3060HD2F10FE</b>	62 ⅞"	30"	195	\$1913	+\$192
	<b>3660HD2F10FE</b>	62 ⅞"	36"	230	\$2169	+\$219
	<b>4260HD2F10FE</b>	62 ⅞"	42"	260	\$2444	+\$246
 <p><b>5 high cabinet</b>  <b>top opening 27" hinged door</b>  <b>cupboard insert with 1 adjustable slotted shelf, 1 opening 10.5" fixed front drawer and 2-12" fixed front drawers</b></p>	<b>3061.5HDF102FE</b>	64 ⅜"	30"	200	\$1915	+\$193
	<b>3661.5HDF102FE</b>	64 ⅜"	36"	235	\$2170	+\$219
	<b>4261.5HDF102FE</b>	64 ⅜"	42"	265	\$2445	+\$246

# 9900 Series Laterals

## Pre-configured Multi-units

### How to order

1. Specify product number.
2. Specify finish color.
3. Specify options.

### Product code key example

**3669-HD4F10E**

- 36** cabinet width  
**69** interior height  
**HD** hinged door  
**4** number of drawers  
**F10** 10 ½" file drawer  
**E** 9900 Series

### General information

Exterior cabinet heights are nominal. Actual heights (with glides fully recessed) are ½" less. Cabinets are priced inclusive 1 pair of hangfile bars in each pullout opening. Hinged doors are standard with self-closing European style hinges that open 110°. Shelves are slotted every 1 ½" and are height adjustable in 1 ½" increments. Shelf dividers are not included.

**Cabinets are 18" in depth.**

### Counterweights

Counterweights are required for ALL freestanding units that are not anchored or ganged to other cabinets or bolted to walls/floor. See Counterweight matrix on page 023.

### Accessories

See Lateral File Accessories section for counterweights and accessories.

### Lock option

Cabinets come standard with lock. If lock is not required add suffix '**NL**' after product number. Deduct \$50 list.

### Finishes

Refer to Finishes section for color options. Drawer bodies and accessories are finished in Eco Black.

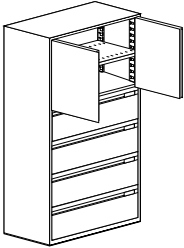
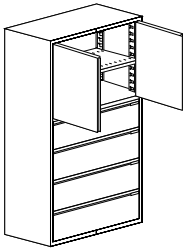
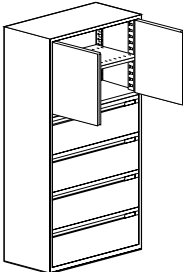
Description	Part number	Exterior height	Width	Weight (lbs)	9900 series/ Neutral paint	Accent paint
 <p><b>5 high cabinet</b>  <b>top opening 27" hinged door</b>  <b>cupboard insert with 1 adjustable slotted shelf other 4 openings</b>  <b>10.5" fixed front drawers</b></p>	<b>3069-HD4F10E</b>	71 7/8"	30"	230	\$2277	+\$229
	<b>3669-HD4F10E</b>	71 7/8"	36"	266	\$2588	+\$260
	<b>4269-HD4F10E</b>	71 7/8"	42"	301	\$2894	+\$291
 <p><b>6 high cabinet</b>  <b>top opening 27" hinged door</b>  <b>cupboard insert with 1 adjustable slotted shelf, 1-10.5" fixed front drawers and 3" 12" fixed front drawers</b></p>	<b>30735HDF103FE</b>	76 3/8"	30"	250	\$2349	+\$236
	<b>36735HDF103FE</b>	76 3/8"	36"	270	\$2667	+\$267
	<b>42735HDF103FE</b>	76 3/8"	42"	291	\$2982	+\$300
 <p><b>6 high cabinet</b>  <b>top opening 27" hinged door</b>  <b>cupboard insert with 1 adjustable slotted shelf, other 4 openings</b>  <b>12" fixed front drawers</b></p>	<b>30-75-HD4FE</b>	77 7/8"	30"	250	\$2384	+\$239
	<b>36-75-HD4FE</b>	77 7/8"	36"	270	\$2697	+\$270
	<b>42-75-HD4FE</b>	77 7/8"	42"	291	\$3010	+\$302

# 9900 Series Laterals

**Pre-configured**  
Mailroom Units with SuperStor™ Insert

## How to order

1. Specify product number.
2. Specify finish color.
3. Specify options.

## Product code key example

**36615-SS3FE**

- 36** cabinet width  
**615** interior height  
**SS** SuperStor™ insert  
**3** number of drawers  
**F** 12" file drawer  
**E** 9900 Series

## General information

Exterior cabinet heights are nominal. Actual heights (with glides fully recessed) are 1/8" less. 25 1/2" and 51" SuperStor inserts have three vertical compartments with slots at 1" increments. Each compartment in the 25 1/2" insert holds 22 trays. Each compartment in the 51" insert holds 48 trays. SuperStor trays, **WHICH ARE SOLD SEPARATELY** slide into the slots. Tray fronts angle downwards 1/2" to permit labeling. Cabinets are priced inclusive 1 pair of hangfile bars in each pullout opening.

**Cabinets are 18" in depth.**

## Counterweights

Counterweights are required for ALL freestanding units that are not anchored or ganged to other cabinets or bolted to walls/floor. See Counterweight matrix on page 023.

## Accessories

See Lateral File Accessories section for counterweights and accessories.

## Lock option

Cabinets come standard with lock. If lock is not required add suffix '/NL' after product number. Deduct \$50 list.

## Finishes

Refer to Finishes section for color options. Drawer bodies and accessories finished in Eco Black. SuperStor and inserts in Onyx.

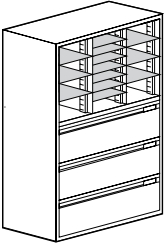
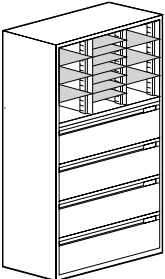
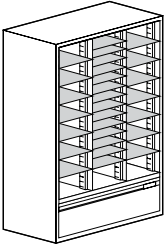
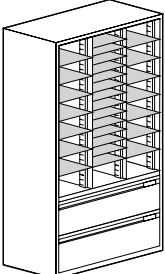
Description	Part number	Exterior height	Width	Weight (lbs)	9900 series/ Neutral paint	Accent paint
 <p>Cabinet with 25.5" SuperStor™ insert and 3-12" fixed front drawers Order trays separately</p>	<b>36615-SS3FE</b>	64 3/8"	36"	199	\$2090	+\$210
 <p>Cabinet with 25.5" SuperStor™ insert and 4-12" fixed front drawers Order trays separately.</p>	<b>36735-SS4FE</b>	76 3/8"	36"	231	\$2592	+\$260
 <p>Cabinet with 51" SuperStor™ insert and 1-10.5" fixed front drawer Order trays separately</p>	<b>36615-SSF10E</b>	64 3/8"	36"	211	\$1801	+\$182
 <p>Cabinet with 51" SuperStor™ insert and 1-10.5" fixed front drawer and 1-12" fixed front drawer Order trays separately</p>	<b>36735-SSF10FE</b>	76 3/8"	36"	243	\$2298	+\$231

# 9900 Series Laterals

## Pre-configured

Mailroom Units with SuperStor™ Insert

### How to order

1. Specify product number.
2. Specify finish color.
3. Specify options.

### Product code key example

#### 36615-SSHD3FE

- 36** cabinet width  
**615** interior height  
**SS** SuperStor™ insert  
**HD** hinged doors  
**3** number of drawers  
**F** 12" file drawer  
**E** 9900 Series

### General information

Exterior cabinet heights are nominal. Actual heights (with glides fully recessed) are ½" less. 25 ½" and 51" SuperStor inserts have three vertical compartments with slots at 1" increments. Each compartment in the 25 ½" insert holds 22 trays. Each compartment in the 51" insert holds 48 trays. SuperStor trays, **WHICH ARE SOLD SEPARATELY** slide into the slots. Tray fronts angle downwards ½" to permit labeling. Cabinets are priced inclusive 1 pair of hangfile bars in each pullout opening.

**Cabinets are 18" in depth.**

### Counterweights

Counterweights are required for ALL freestanding units that are not anchored or ganged to other cabinets or bolted to walls/floor. See Counterweight matrix on page 023.

### Accessories

See Lateral File Accessories section for counterweights and accessories.

### Lock option

Cabinets come standard with lock. If lock is not required add suffix '/NL' after product number. Deduct \$50 list.

### Finishes

Refer to Finishes section for color options. Drawer bodies and accessories finished in Eco Black. SuperStor and inserts in Onyx.

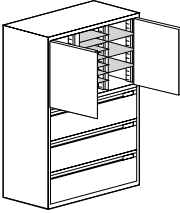
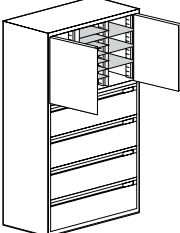
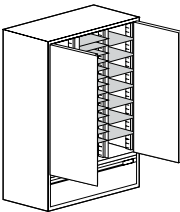
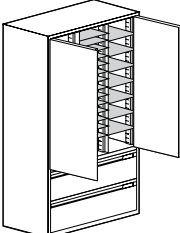
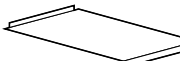
Description	Part number	Exterior height	Width	Weight (lbs)	9900 series/ Neutral paint	Accent paint
 <p>Cabinet with 25.5" SuperStor™ insert with hinged doors and 3-12" fixed front drawers Order trays separately</p>	<b>36615-SSHD3FE</b>	64 ¾"	36"	224	\$2416	+\$243
 <p>Cabinet with 25.5" SuperStor™ insert with hinged doors and 4-12" fixed front drawers Order trays separately</p>	<b>36735-SSHD4FE</b>	76 ¾"	36"	256	\$2914	+\$293
 <p>Cabinet with 51" SuperStor™ insert with hinged doors and 1-10.5" fixed front drawer Order trays separately</p>	<b>36615-SSHDF10E</b>	64 ¾"	36"	296	\$2329	+\$234
 <p>Cabinet with 51" SuperStor™ insert with hinged doors and 1-10.5" fixed front drawer and 1-12" fixed front drawer Order trays separately</p>	<b>36735-SSHDF10FE</b>	76 ¾"	36"	328	\$2829	+\$285
 <p>SuperStor™ trays Pack of 12 trays, black only</p>	<b>T12SS-BL</b>	—	10"	25	\$240	—



### How to order

1. Specify product number.
2. Specify finish color.
3. Specify options.

### Product code key example

#### 3615SDO-SH

**36** cabinet width  
**15** interior height  
**SDO** sliding doors  
**SH** shelves

### General information

Shelves are slotted every 1 1/2" and are height adjustable in 1 1/2" increments. Shelf dividers are not included.

**Cabinets are 18" in depth.**

**Note: Lock is located center bottom of the case**

### Accessories

See Lateral File Accessories section for counterweights and accessories.

### Lock option

Cabinets come standard with lock. If lock is not required add suffix '/NL' after product number. Deduct \$50 list.

### Finishes

Refer to Finishes section for color options. Drawer bodies and accessories are finished in Eco Black.

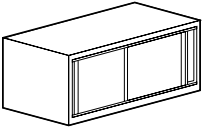
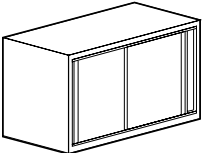
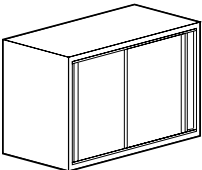
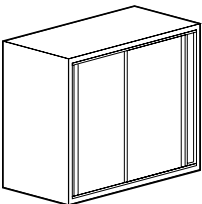
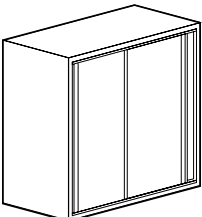
Description	Part number	Exterior height	Width	Weight (lbs)	Storage centers/ 9900 Series/ Neutral paint	Accent paint	
	Cabinet with sliding doors, no interior accessories	<b>3015SDO</b>	17 7/8"	30"	39	\$660	+\$66
		<b>3615SDO</b>	17 7/8"	36"	48	\$717	+\$74
		<b>4215SDO</b>	17 7/8"	42"	57	\$757	+\$78
	Cabinet with sliding doors with 1 slotted shelf	<b>3015SDO-SH</b>	17 7/8"	30"	49	\$753	+\$77
		<b>3615SDO-SH</b>	17 7/8"	36"	59	\$812	+\$83
		<b>4215SDO-SH</b>	17 7/8"	42"	69	\$850	+\$87
	Cabinet with sliding doors, no interior accessories	<b>3021SDO</b>	23 7/8"	30"	47	\$729	+\$75
		<b>3621SDO</b>	23 7/8"	36"	65	\$778	+\$80
		<b>4221SDO</b>	23 7/8"	42"	83	\$829	+\$85
	Cabinet with sliding doors with 1 slotted shelf	<b>3021SDO-SH</b>	23 7/8"	30"	57	\$821	+\$84
		<b>3621SDO-SH</b>	23 7/8"	36"	76	\$872	+\$89
		<b>4221SDO-SH</b>	23 7/8"	42"	95	\$924	+\$94
	Cabinet with sliding doors, no interior accessories	<b>3024SDO</b>	26 7/8"	30"	75	\$729	+\$75
		<b>3624SDO</b>	26 7/8"	36"	95	\$778	+\$80
		<b>4224SDO</b>	26 7/8"	42"	110	\$829	+\$85
	Cabinet with sliding doors with 1 slotted shelf	<b>3024SDO-SH</b>	26 7/8"	30"	85	\$821	+\$84
		<b>3624SDO-SH</b>	26 7/8"	36"	105	\$872	+\$89
		<b>4224SDO-SH</b>	26 7/8"	42"	115	\$924	+\$94
	Cabinet with sliding doors, no interior accessories	<b>3027SDO</b>	29 7/8"	30"	83	\$795	+\$81
		<b>3627SDO</b>	29 7/8"	36"	104	\$827	+\$84
		<b>4227SDO</b>	29 7/8"	42"	120	\$899	+\$91
	Cabinet with sliding doors with 1 slotted shelf	<b>3027SDO-SH</b>	29 7/8"	30"	94	\$888	+\$90
		<b>3627SDO-SH</b>	29 7/8"	42"	117	\$922	+\$94
		<b>4227SDO-SH</b>	29 7/8"	42"	135	\$993	+\$100
	Cabinet with sliding doors, no interior accessories	<b>3030SDO</b>	32 7/8"	30"	115	\$840	+\$86
		<b>3630SDO</b>	32 7/8"	36"	120	\$871	+\$89
		<b>4230SDO</b>	32 7/8"	42"	130	\$963	+\$97
	Cabinet with sliding doors with 1 slotted shelf	<b>3030SDO-SH</b>	32 7/8"	30"	120	\$933	+\$95
		<b>3630SDO-SH</b>	32 7/8"	36"	135	\$964	+\$98
		<b>4230SDO-SH</b>	32 7/8"	42"	140	\$1054	+\$107



# 9900 Series Laterals

## Pre-configured

Overfile and Storage Cabinets

### How to order

1. Specify product number.
2. Specify finish color.
3. Specify options.

### Product code key example

#### 3621HDE-SH

**36** cabinet width  
**21** interior height  
**HD** hinged doors  
**E** 9900 Series  
**SH** shelves

### General information

Exterior cabinet heights are nominal. Actual heights (with glides fully recessed) are 1/8" less. Hinged doors are standard with self-closing European style hinges that open 110°. Shelves are slotted every 1 1/2" and are height adjustable in 1 1/2" increments. Shelf dividers are not included.

**Cabinets are 18" in depth.**

### Accessories

See Lateral File Accessories section for counterweights and accessories.

### Lock option

Cabinets come standard with lock. If lock is not required add suffix **'/NL'** after product number. Deduct \$50 list.

### Finishes

Refer to Finishes section for color options. Drawer bodies and accessories are finished in Eco Black.

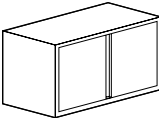
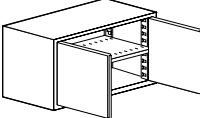
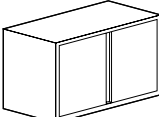
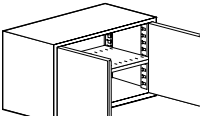
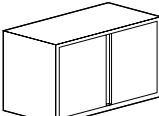
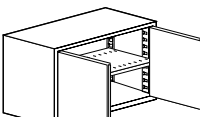
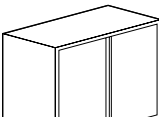
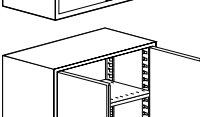
Description	Part number	Exterior height	Width	Weight (lbs)	9900 series/ Neutral paint	Accent paint
	<b>3021HDE</b>	23 7/8"	30"	47	\$717	+\$74
	<b>3621HDE</b>	23 7/8"	36"	65	\$766	+\$79
	<b>4221HDE</b>	23 7/8"	42"	83	\$817	+\$84
	<b>3021HDE-SH</b>	23 7/8"	30"	57	\$809	+\$83
	<b>3621HDE-SH</b>	23 7/8"	36"	76	\$858	+\$87
	<b>4221HDE-SH</b>	23 7/8"	42"	95	\$910	+\$92
	<b>3024HDE</b>	26 7/8"	30"	75	\$717	+\$74
	<b>3624HDE</b>	26 7/8"	36"	95	\$766	+\$79
	<b>4224HDE</b>	26 7/8"	42"	110	\$817	+\$84
	<b>3024HDE-SH</b>	26 7/8"	30"	85	\$809	+\$83
	<b>3624HDE-SH</b>	26 7/8"	36"	105	\$858	+\$87
	<b>4224HDE-SH</b>	26 7/8"	42"	115	\$910	+\$92
	<b>3027HDE</b>	29 7/8"	30"	83	\$783	+\$80
	<b>3627HDE</b>	29 7/8"	36"	104	\$814	+\$83
	<b>4227HDE</b>	29 7/8"	42"	120	\$884	+\$90
	<b>3027HDE-SH</b>	29 7/8"	30"	94	\$876	+\$89
	<b>3627HDE-SH</b>	29 7/8"	36"	117	\$906	+\$92
	<b>4227HDE-SH</b>	29 7/8"	42"	135	\$978	+\$99
	<b>3030HDE</b>	32 7/8"	30"	115	\$826	+\$84
	<b>3630HDE</b>	32 7/8"	36"	120	\$857	+\$87
	<b>4230HDE</b>	32 7/8"	42"	130	\$946	+\$96
	<b>3030HDE-SH</b>	32 7/8"	30"	120	\$919	+\$93
	<b>3630HDE-SH</b>	32 7/8"	36"	135	\$947	+\$96
	<b>4230HDE-SH</b>	32 7/8"	42"	140	\$1038	+\$106

# 9900 Series Laterals

**Pre-configured**  
Storage and Wardrobe Cabinets

## How to order

1. Specify product number.
2. Specify finish color.
3. Specify options.

## Product code key example

**3636HD□-SH**

**36** cabinet width  
**36** interior height  
**HD** hinged doors  
**E** 9900 Series  
**SH** shelves

## General information

Exterior cabinet heights are nominal. Actual heights (with glides fully recessed) are  $\frac{1}{8}$ " less. Hinged doors are standard with self-closing European style hinges that open 110°. Shelves are slotted every 1  $\frac{1}{2}$ " and are height adjustable in 1  $\frac{1}{2}$ " increments. Shelf dividers are not included.

**Cabinets are 18" in depth.**

## Accessories

See Lateral File Accessories section for counterweights and accessories.

## Lock option

Cabinets come standard with lock. If lock is not required add suffix '/NL' after product number. Deduct \$50 list.

## Finishes

Refer to Finishes section for color options. Drawer bodies and accessories are finished in Eco Black.

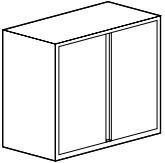
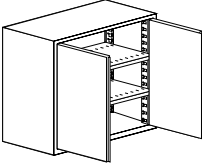
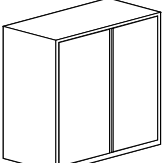
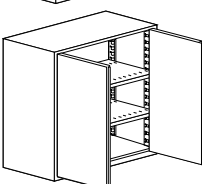
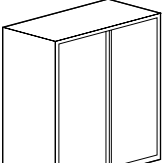
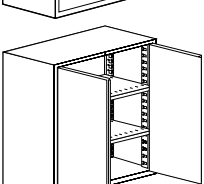
Description	Part number	Exterior height	Width	Weight (lbs)	9900 series/ Neutral paint	Accent paint
	<b>3036HDE</b>	38 $\frac{7}{8}$ "	30"	130	\$841	+\$86
	<b>3636HDE</b>	38 $\frac{7}{8}$ "	36"	140	\$922	+\$94
	<b>4236HDE</b>	38 $\frac{7}{8}$ "	42"	150	\$1014	+\$102
	<b>3036HDE-SH</b>	38 $\frac{7}{8}$ "	30"	145	\$1024	+\$103
	<b>3636HDE-SH</b>	38 $\frac{7}{8}$ "	36"	155	\$1105	+\$112
	<b>4236HDE-SH</b>	38 $\frac{7}{8}$ "	42"	165	\$1197	+\$121
	<b>3040.5HDE</b>	43 $\frac{3}{8}$ "	30"	135	\$870	+\$89
	<b>3640.5HDE</b>	43 $\frac{3}{8}$ "	36"	145	\$974	+\$99
	<b>4240.5HDE</b>	43 $\frac{3}{8}$ "	42"	160	\$1104	+\$112
	<b>3040.5HDE-SH</b>	43 $\frac{3}{8}$ "	30"	145	\$1054	+\$107
	<b>3640.5HDE-SH</b>	43 $\frac{3}{8}$ "	36"	155	\$1157	+\$117
	<b>4240.5HDE-SH</b>	43 $\frac{3}{8}$ "	42"	165	\$1287	+\$129
	<b>3045HDE</b>	47 $\frac{7}{8}$ "	30"	135	\$895	+\$91
	<b>3645HDE</b>	47 $\frac{7}{8}$ "	36"	145	\$1039	+\$106
	<b>4245HDE</b>	47 $\frac{7}{8}$ "	42"	155	\$1190	+\$120
	<b>3045HDE-SH</b>	47 $\frac{7}{8}$ "	30"	145	\$1080	+\$110
	<b>3645HDE-SH</b>	47 $\frac{7}{8}$ "	36"	155	\$1222	+\$123
	<b>4245HDE-SH</b>	47 $\frac{7}{8}$ "	42"	165	\$1371	+\$139

# 9900 Series Laterals

## Pre-configured

Storage and Wardrobe Cabinets

### How to order

1. Specify product number.
2. Specify finish color.
3. Specify options.

### Product code key example

**3648HDE-SH**

**36** cabinet width  
**48** interior height  
**HD** hinged doors  
**E** 9900 Series  
**SH** shelves

### General information

Exterior cabinet heights are nominal. Actual heights (with glides fully recessed) are  $\frac{1}{8}$ " less. Hinged doors are standard with self-closing European style hinges that open 110°. Shelves are slotted every 1  $\frac{1}{2}$ " and are height adjustable in 1  $\frac{1}{2}$ " increments. Shelf dividers are not included.

**Cabinets are 18" in depth.**

### Accessories

See Lateral File Accessories section for counterweights and accessories.

### Lock option

Cabinets come standard with lock. If lock is not required add suffix **'/NL'** after product number. Deduct \$50 list.

### Finishes

Refer to Finishes section for color options. Drawer bodies and accessories are finished in Eco Black.

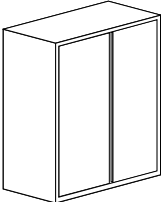
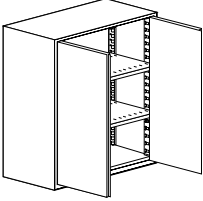
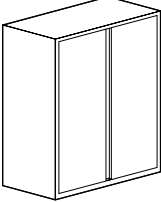
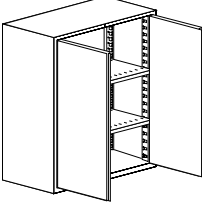
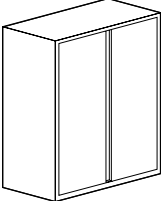
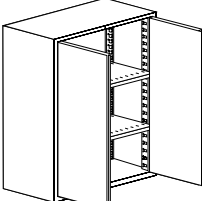
Description	Part number	Exterior height	Width	Weight (lbs)	9900 series/ Neutral paint	Accent paint
	<b>3048HDE</b>	50 $\frac{7}{8}$ "	30"	160	\$951	+\$96
	<b>3648HDE</b>	50 $\frac{7}{8}$ "	36"	170	\$1082	+\$110
	<b>4248HDE</b>	50 $\frac{7}{8}$ "	42"	190	\$1230	+\$124
	<b>3048HDE-SH</b>	50 $\frac{7}{8}$ "	30"	165	\$1136	+\$115
	<b>3648HDE-SH</b>	50 $\frac{7}{8}$ "	36"	175	\$1265	+\$127
	<b>4248HDE-SH</b>	50 $\frac{7}{8}$ "	42"	195	\$1414	+\$144
	<b>3049.5HDE</b>	52 $\frac{3}{8}$ "	30"	160	\$951	+\$96
	<b>3649.5HDE</b>	52 $\frac{3}{8}$ "	36"	170	\$1082	+\$110
	<b>4249.5HDE</b>	52 $\frac{3}{8}$ "	42"	190	\$1230	+\$124
	<b>3049.5HDE-SH</b>	52 $\frac{3}{8}$ "	30"	170	\$1136	+\$115
	<b>3649.5HDE-SH</b>	52 $\frac{3}{8}$ "	36"	180	\$1265	+\$127
	<b>4249.5HDE-SH</b>	52 $\frac{3}{8}$ "	42"	200	\$1414	+\$144
	<b>3052.5HDE</b>	55 $\frac{3}{8}$ "	30"	160	\$967	+\$98
	<b>3652.5HDE</b>	55 $\frac{3}{8}$ "	36"	170	\$1106	+\$112
	<b>4252.5HDE</b>	55 $\frac{3}{8}$ "	42"	190	\$1274	+\$128
	<b>3052.5HDE-SH</b>	55 $\frac{3}{8}$ "	30"	170	\$1149	+\$116
	<b>3652.5HDE-SH</b>	55 $\frac{3}{8}$ "	36"	180	\$1291	+\$130
	<b>4252.5HDE-SH</b>	55 $\frac{3}{8}$ "	42"	200	\$1459	+\$148

# 9900 Series Laterals

**Pre-configured**  
Storage and Wardrobe Cabinets

## How to order

1. Specify product number.
2. Specify finish color.
3. Specify options.

## Product code key example

**3654HDE-SH**

**36** cabinet width  
**54** interior height  
**HD** hinged doors  
**E** 9900 Series  
**SH** shelves

## General information

Exterior cabinet heights are nominal. Actual heights (with glides fully recessed) are 1/8" less. Hinged doors are standard with self-closing European style hinges that open 110°. Shelves are slotted every 1 1/2" and are height adjustable in 1 1/2" increments. Shelf dividers are not included.

**Cabinets are 18" in depth.**

## Accessories

See Lateral File Accessories section for counterweights and accessories.

## Lock option

Cabinets come standard with lock. If lock is not required add suffix '/NL' after product number. Deduct \$50 list.

## Finishes

Refer to Finishes section for color options. Drawer bodies and accessories are finished in Eco Black.

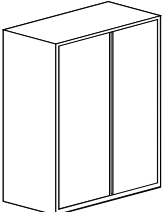
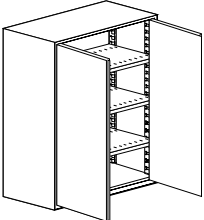
Description	Part number	Exterior height	Width	Weight (lbs)	9900 series/ Neutral paint	Accent paint	
	Cabinet with hinged doors no interior accessories	<b>3054HDE</b>	56 7/8"	30"	165	\$974	+\$99
		<b>3654HDE</b>	56 7/8"	36"	175	\$1110	+\$113
		<b>4254HDE</b>	56 7/8"	42"	195	\$1151	+\$116
	Cabinet with hinged doors with 3 slotted shelves	<b>3054HDE-SH</b>	56 7/8"	30"	180	\$1248	+\$126
		<b>3654HDE-SH</b>	56 7/8"	36"	190	\$1384	+\$140
		<b>4254HDE-SH</b>	56 7/8"	42"	210	\$1553	+\$157

# 9900 Series Laterals

## Pre-configured

Storage and Wardrobe Cabinets

### How to order

1. Specify product number.
2. Specify finish color.
3. Specify options.

### Product code key example

**3660HDE-SH**

**36** cabinet width  
**60** interior height  
**HD** hinged doors  
**E** 9900 Series  
**SH** shelves

### General information

Exterior cabinet heights are nominal. Actual heights (with glides fully recessed) are  $\frac{1}{8}$ " less. Hinged doors are standard with self-closing European style hinges that open 110°. Shelves are slotted every 1  $\frac{1}{2}$ " and are height adjustable in 1  $\frac{1}{2}$ " increments. Shelf dividers are not included.

**Cabinets are 18" in depth.**

### Accessories

See Lateral File Accessories section for counterweights and accessories.

### Lock option

Cabinets come standard with lock. If lock is not required add suffix '/NL' after product number. Deduct \$50 list.

### Finishes

Refer to Finishes section for color options. Drawer bodies and accessories are finished in Eco Black.

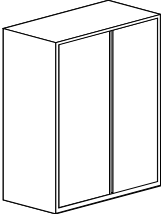
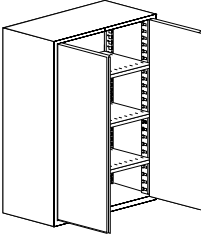
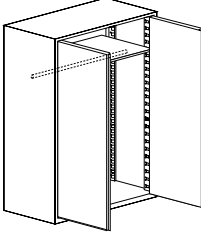
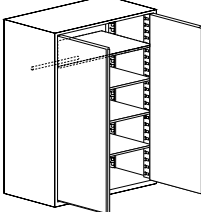
Description	Part number	Exterior height	Width	Weight (lbs)	9900 series/ Neutral paint	Accent paint	
	Cabinet with hinged doors no interior accessories	<b>3060HDE</b>	62 $\frac{7}{8}$ "	30"	170	\$980	+\$99
		<b>3660HDE</b>	62 $\frac{7}{8}$ "	36"	185	\$1113	+\$113
		<b>4260HDE</b>	62 $\frac{7}{8}$ "	42"	210	\$1281	+\$129
	Cabinet with hinged doors with 3 slotted shelves	<b>3060HDE-SH</b>	62 $\frac{7}{8}$ "	30"	185	\$1254	+\$126
		<b>3660HDE-SH</b>	62 $\frac{7}{8}$ "	36"	200	\$1390	+\$140
		<b>4260HDE-SH</b>	62 $\frac{7}{8}$ "	42"	220	\$1556	+\$157
	Cabinet with 1 blank shelf and side-to-side coat rod	<b>3060HDE-W</b>	62 $\frac{7}{8}$ "	30"	175	\$1104	+\$112
		<b>3660HDE-W</b>	62 $\frac{7}{8}$ "	36"	185	\$1240	+\$125
		<b>4260HDE-W</b>	62 $\frac{7}{8}$ "	42"	215	\$1406	+\$143
	Cabinet with hinged doors, 1 full width blank shelf, 3 half width shelves and 1 half width coat rod	<b>3060HDE-WS</b>	62 $\frac{7}{8}$ "	30"	175	\$1316	+\$132
		<b>3660HDE-WS</b>	62 $\frac{7}{8}$ "	36"	185	\$1452	+\$147
		<b>4260HDE-WS</b>	62 $\frac{7}{8}$ "	42"	215	\$1619	+\$163

# 9900 Series Laterals

**Pre-configured**  
Storage and Wardrobe Cabinets

## How to order

1. Specify product number.
2. Specify finish color.
3. Specify options.

## Product code key example

### 3661.5HDE-SH

**36** cabinet width  
**61.5** interior height  
**HD** hinged doors  
**E** 9900 Series  
**SH** shelves

## General information

Exterior cabinet heights are nominal. Actual heights (with glides fully recessed) are 1/8" less. Hinged doors are standard with self-closing European style hinges that open 110°. Shelves are slotted every 1 1/2" and are height adjustable in 1 1/2" increments. Shelf dividers are not included.

**Cabinets are 18" in depth.**

## Accessories

See Lateral File Accessories section for counterweights and accessories.

## Lock option

Cabinets come standard with lock. If lock is not required add suffix '/NL' after product number. Deduct \$50 list.

## Finishes

Refer to Finishes section for color options. Drawer bodies and accessories are finished in Eco Black.

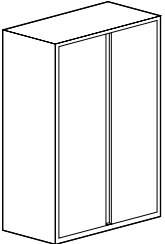
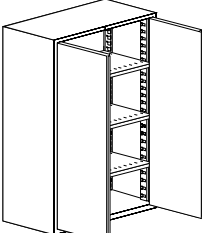
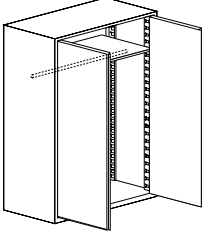
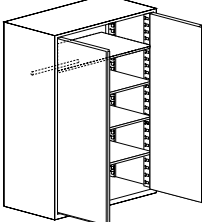
Description	Part number	Exterior height	Width	Weight (lbs)	9900 series/ Neutral paint	Accent paint	
	Cabinet with hinged doors no interior accessories	<b>3061.5HDE</b>	64 3/8"	30"	175	\$980	+\$99
		<b>3661.5HDE</b>	64 3/8"	36"	185	\$1113	+\$113
		<b>4261.5HDE</b>	64 3/8"	42"	215	\$1281	+\$129
	Cabinet with hinged doors with 3 slotted shelves	<b>3061.5HDE-SH</b>	64 3/8"	30"	185	\$1254	+\$126
		<b>3661.5HDE-SH</b>	64 3/8"	36"	200	\$1390	+\$140
		<b>4261.5HDE-SH</b>	64 3/8"	42"	220	\$1556	+\$157
	Cabinet with hinged doors, 1 blank shelf and side-to-side coat rod	<b>3061.5HDE-W</b>	64 3/8"	30"	175	\$1104	+\$112
		<b>3661.5HDE-W</b>	64 3/8"	36"	185	\$1240	+\$125
		<b>4261.5HDE-W</b>	64 3/8"	42"	215	\$1406	+\$143
	Cabinet with hinged doors, 1 full width blank shelf, 3 half width shelves and 1 half width coat rod	<b>3061.5HDE-WS</b>	64 3/8"	30"	180	\$1316	+\$132
		<b>3661.5HDE-WS</b>	64 3/8"	36"	190	\$1450	+\$147
		<b>4261.5HDE-WS</b>	64 3/8"	42"	220	\$1619	+\$163

# 9900 Series Laterals

## Pre-configured

Storage and Wardrobe Cabinets

### How to order

1. Specify product number.
2. Specify finish color.
3. Specify options.

### Product code key example

**3667.5HDE-SH**

**36** cabinet width  
**67.5** interior height  
**HD** hinged doors  
**E** 9900 Series  
**SH** shelves

### General information

Exterior cabinet heights are nominal. Actual heights (with glides fully recessed) are 1/8" less. Hinged doors are standard with self-closing European style hinges that open 110°. Shelves are slotted every 1 1/2" and are height adjustable in 1 1/2" increments. Shelf dividers are not included.

**Cabinets are 18" in depth.**

### Accessories

See Lateral File Accessories section for counterweights and accessories.

### Lock option

Cabinets come standard with lock. If lock is not required add suffix '/NL' after product number. Deduct \$50 list.

### Finishes

Refer to Finishes section for color options. Drawer bodies and accessories are finished in Eco Black.

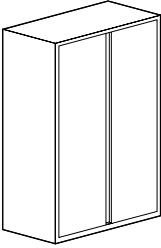
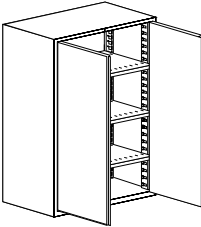
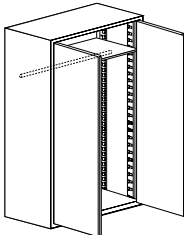
Description	Part number	Exterior height	Width	Weight (lbs)	9900 series/ Neutral paint	Accent paint
	<b>3067.5HDE</b>	70 3/8"	30"	185	\$1083	+\$110
	<b>3667.5HDE</b>	70 3/8"	36"	210	\$1233	+\$124
	<b>4267.5HDE</b>	70 3/8"	42"	225	\$1397	+\$142
	<b>3067.5HDE-SH</b>	70 3/8"	30"	205	\$1450	+\$147
	<b>3667.5HDE-SH</b>	70 3/8"	36"	230	\$1597	+\$161
	<b>4267.5HDE-SH</b>	70 3/8"	42"	245	\$1763	+\$178
	<b>3067.5HDE-W</b>	70 3/8"	30"	190	\$1207	+\$122
	<b>3667.5HDE-W</b>	70 3/8"	36"	215	\$1358	+\$136
	<b>4267.5HDE-W</b>	70 3/8"	42"	230	\$1520	+\$154

# 9900 Series Laterals

**Pre-configured**  
Storage and Wardrobe Cabinets

## How to order

1. Specify product number.
2. Specify finish color.
3. Specify options.

## Product code key example

**3673.5HDE-SH**

**36** cabinet width  
**73.5** interior height  
**HD** hinged doors  
**E** 9900 Series  
**SH** shelves

## General information

Exterior cabinet heights are nominal. Actual heights (with glides fully recessed) are  $\frac{1}{8}$ " less. Hinged doors are standard with self-closing European style hinges that open 110°. Shelves are slotted every 1  $\frac{1}{2}$ " and are height adjustable in 1  $\frac{1}{2}$ " increments. Shelf dividers are not included.

**Cabinets are 18" in depth.**

## Accessories

See Lateral File Accessories section for counterweights and accessories.

## Lock option

Cabinets come standard with lock. If lock is not required add suffix '**/NL**' after product number. Deduct \$50 list.

## Finishes

Refer to Finishes section for color options. Drawer bodies and accessories are finished in Eco Black.

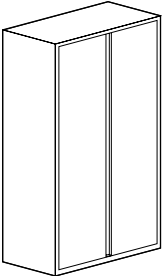
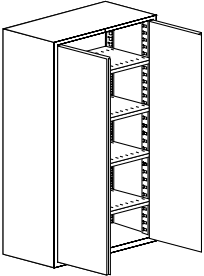
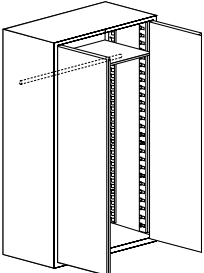
Description	Part number	Exterior height	Width	Weight (lbs)	9900 series/ Neutral paint	Accent paint
	Cabinet with hinged doors, no interior accessories	<b>3073.5HDE</b>	76 $\frac{3}{8}$ "	30"	190	\$1188 +\$120
		<b>3673.5HDE</b>	76 $\frac{3}{8}$ "	36"	220	\$1349 +\$135
		<b>4273.5HDE</b>	76 $\frac{3}{8}$ "	42"	240	\$1516 +\$153
	Cabinet with hinged doors with 4 slotted shelves	<b>3073.5HDE-SH</b>	76 $\frac{3}{8}$ "	30"	210	\$1553 +\$157
		<b>3673.5HDE-SH</b>	76 $\frac{3}{8}$ "	36"	240	\$1716 +\$174
		<b>4273.5HDE-SH</b>	76 $\frac{3}{8}$ "	42"	260	\$1881 +\$189
	Cabinet with hinged doors 1 blank shelf and side-to-side coat rod	<b>3073.5HDE-W</b>	76 $\frac{3}{8}$ "	30"	195	\$1311 +\$132
		<b>3673.5HDE-W</b>	76 $\frac{3}{8}$ "	36"	225	\$1472 +\$149
		<b>4273.5HDE-W</b>	76 $\frac{3}{8}$ "	42"	245	\$1640 +\$165



# 9900 Series Laterals

## Pre-configured

Storage Cabinet with SuperStor™ Insert

### How to order

1. Specify product number.
2. Specify finish color.
3. Specify options.

### Product code key example

**3624DHE-SS**

**36** cabinet width  
**24** interior height  
**HD** hinged doors  
**E** 9900 Series  
**SS** SuperStor™

### General information

Exterior cabinet heights are nominal. Actual heights (with glides fully recessed) are  $\frac{1}{8}$ " less. SuperStor™ cabinets are equipped with an internal storage organizer that consists of three vertical compartments with slots at 1" increments. SuperStor™ trays, **WHICH ARE SOLD SEPARATELY**, slide into the slots. Tray fronts angle downwards  $\frac{1}{2}$ " to permit labeling. Hinged doors are standard with self-closing European style hinges that open 110°.

**Cabinets are 18" in depth.**

### Accessories

See Lateral File Accessories section for counterweights and accessories.

### Lock option

Cabinets come standard with lock. If lock is not required add suffix '/NL' after product number. Deduct \$50 list.

### Finishes

Refer to Finishes section for color options. Drawer bodies and accessories are finished in Eco Black. SuperStor and trays are finishes in Onyx only.

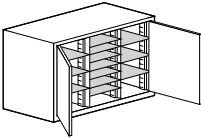
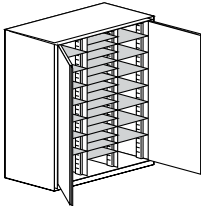
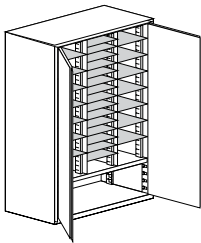
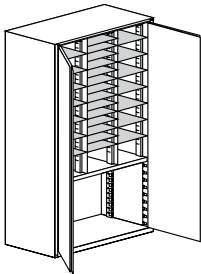
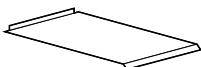
Description	Part number	Exterior height	Width	Weight (lbs)	9900 series/ Neutral paint	Accent paint
 <p>Cabinet with 24" high SuperStor™ insert. Three vertical compartments with slots at 1" increments hold 22 sliding trays per compartment. Order trays separately</p>	<b>3624HDE-SS</b>	26 $\frac{7}{8}$ "	36"	120	\$1210	+\$122
 <p>Cabinet with 49.5" high SuperStor™ insert. Three vertical compartments with slots at 1" increments hold 48" sliding trays per compartment. Order trays separately</p>	<b>3649.5HDE-SS</b>	53 $\frac{3}{8}$ "	36"	190	\$1774	+\$179
 <p>Cabinet with 49.5" high SuperStor™ insert. Three vertical compartments with slots at 1" increments hold 48" sliding trays per compartment. 10.5" clearance from bottom of cabinet to bottom of insert. Order trays separately.</p>	<b>3661.5HDE-SS</b>	64 $\frac{3}{8}$ "	36"	235	\$1840	+\$185
 <p>Cabinet with 49.5" high SuperStor™ insert. Three vertical compartments with slots at 1" increments hold 48" sliding trays per compartment. 22.5" clearance from bottom of cabinet to bottom of insert Order trays separately.</p>	<b>3673.5HDE-SS</b>	76 $\frac{3}{8}$ "	36"	270	\$2073	+\$209
 <p>SuperStor™ trays Pack of 12 trays, black only</p>	<b>T12SS-BL</b>	—	10"	25	\$240	—

# 9900 Series Laterals

**Pre-configured**  
Bookcase/File Combination Cabinets

## How to order

1. Specify product number.
2. Specify finish color.
3. Specify options.

## Product code key example

**36495E-2F101SH**

**36** cabinet width  
**495** interior height  
**E** 9900 Series  
**2** number of drawers  
**F10** 10 1/2" fixed front drawers  
**1SH** number of adjustable shelves

## General information

Exterior cabinet heights are nominal. Actual heights (with glides fully recessed) are 1/8" less. Cabinets are priced inclusive of 1 pair of hangfile bars in each pullout opening. Shelves are adjustable except the shelf above the file drawers. All shelves are slotted to accept dividers. Shelf dividers are not included. See Accessories section.

**Cabinets are 18" in depth.**

## Counterweights

Counterweights are required for ALL freestanding units that are not anchored or ganged to other cabinets or bolted to walls/floor. See Counterweight matrix on page 023.

## Accessories

See Lateral File Accessories section for counterweights and accessories.

## Lock option

Cabinets come standard with lock. If lock is not required add suffix '/NL' after product number. Deduct \$50 list.

## Finishes

Refer to Finishes section for color options. Drawer bodies and accessories are finished in Eco Black.

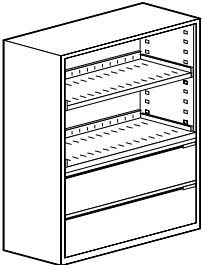
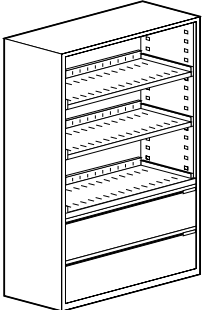
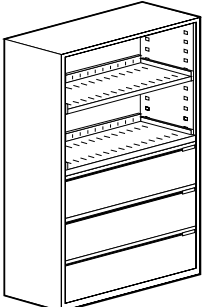
Description	Part number	Exterior height	Width	Weight (lbs)	9900 series/ Neutral paint	Accent paint
 <p><b>4 high cabinet with 2 bookcase openings and 2-10.5" drawers</b></p> <p><b>Bookcase Opening Clearances</b>  <b>Top 12.5"</b>  <b>Bottom 14"</b></p>	<b>30495E-2F101SH</b>	52 3/8"	30"	165	\$1309	+\$132
	<b>36495E-2F101SH</b>	52 3/8"	36"	183	\$1522	+\$154
	<b>42495E-2F101SH</b>	52 3/8"	42"	210	\$1713	+\$173
 <p><b>5 high cabinet with 3 bookcase openings and 2-10.5" drawers</b></p> <p><b>Bookcase Opening Clearances</b>  <b>Top 12.5"</b>  <b>Middle 12.5"</b>  <b>Bottom 13"</b></p>	<b>30615E-2F102SH</b>	64 3/8"	30"	187	\$1449	+\$147
	<b>36615E-2F102SH</b>	64 3/8"	36"	210	\$1638	+\$165
	<b>42615E-2F102SH</b>	64 3/8"	42"	240	\$1840	+\$185
 <p><b>5 high cabinet with 2 bookcase openings and 3-10.5" drawers</b></p> <p><b>Bookcase Opening Clearances</b>  <b>Top 14"</b>  <b>Bottom 14"</b></p>	<b>30615E-3F101SH</b>	64 3/8"	30"	190	\$1451	+\$147
	<b>36615E-3F101SH</b>	64 3/8"	36"	212	\$1851	+\$186
	<b>42615E-3F101SH</b>	64 3/8"	42"	243	\$2085	+\$210

# 9900 Series Laterals

## Build-ups

### ANSI/BIFMA

With the addition of counterweights where appropriate, lateral files meet all ANSI/BIFMA specifications.

### Construction

Lateral files and hinged door cabinets are of all-welded construction using 20 and 22 gauge high quality, tension leveled, cold rolled steel. The steel gauges selected for drawer fronts, bodies and accessories ensure the highest quality, durability and performance for all components.

### Construction features & benefits

- All interiors are modular and interchangeable so that cabinets can be retrofitted with new accessories and interiors as required.
- Corners are strengthened with a reinforcing gusset and are welded at junction of top and case fronts, eliminating horizontal lines for a cleaner, flush appearance on the face of the cabinet.
- Full width pulls allow lift-up doors and drawers to be opened from any position.
- Rigid construction allows lift-up doors to be picked up and retracted smoothly from any point, eliminates deformation, ensures flush fit within the cabinet and improves lock performance.
- Lift-up door carrier mechanism has four nylon rollers, two on each side, for smooth receding action with no binding or snagging.
- Front leading edge of pullout shelves is beaded and rolled to provide grip for pullout action and to strengthen shelf; front leading edge of fixed shelf is flat for easy removal of material.
- Fully-progressive ball bearing suspensions are staged so that left and right sides work in unison. This provides smooth drawer operation with minimum force.
- Special "claw-like" device incorporated in suspensions "grips" the fixed section of the suspension arm preventing drawer bounce-back or creep when drawer is closed.
- Lock bars operate vertically on both sides of the cabinet for maximum security.
- Lock fingers are configured with right angle bend upward, not downward, so that lift-up doors cannot be pulled down to disengage fingers from door slots and be forced to circumvent lock system.
- Plastic buttons in side gables of case where top sections of lift-up doors recede into the cabinet eliminate metal-to-metal contact.
- Plastic buttons in the ends of each drawer and door front eliminates metal-to-metal contact between cabinet sides and closed drawers.
- Self-closing, 110° opening, European style cupboard hinges provide smooth hinged door operation. Hinges are not visible from the exterior of the cabinet.

### Bases

Optional base aprons are available in 2 heights and are screwed to the underside of the cabinet. Bases may be easily added or changed on site. Cabinets are shipped with bases installed when ordered.

### Counterweights

Counterweights are required for ALL freestanding units that are not anchored or ganged to other cabinets or bolted to walls/floor.

### Safelock™

The patented Safelock mechanism provides complete security against accidental opening of two or more drawers simultaneously. When any drawer or single pullout shelf is extended, even fractionally, Safelock ensures that all other openings, except for the 3" and 4 1/2" drawers, immediately become inoperable. Safelock is standard on all lateral files. The only exceptions are the 3" and 4 1/2" drawers and the upper shelf in a two pullout shelf opening.

### Drawer standard equipment

Pullout drawers and shelves are standard with one pair hangfile bars for side-to-side suspended filing. Fixed shelves are standard with 3 plate dividers. Optional accessories are available.

### Glides

Overall heights are inclusive of metal glides. Heights may be increased up to 5/8" by extending standard glide. Glides are accessible from inside the cabinet when the bottom drawer is fully extended or removed and may be adjusted with a 1/4" socket driver.

Optional 1 1/2" stem glides are available.

Specify separately and add \$26 list to the cabinet price. Requires field installation.

### Locks

Cabinets come standard with lock. If lock is not required add suffix 'N/L' after product number. Deduct \$50 list per lock. For lock location, see diagrams at the front of this price list.

**Note: 3" and 4 1/2" drawers, when located immediately above a case bottom, tie bar shelf or reference shelves cannot be locked.**

Random keying is standard. Files may be ordered keyed alike. Specify. Locks feature removable core and are standard with two keys, one of which has a black neoprene plastic key cover.

Cabinets originally ordered as non-locking may be field installed with the addition of locking bars and a lock core. Please contact Inscape Client Services for required parts.

Master keys are available at \$45 list.

### Lateral File Tops

Refer to Accessories section to order Laminate, Nuform and Veneer tops.

### Finishes

Refer to Finishes section of this price list. For lock finish options, refer to the front of this price list.

### Drawer pulls

9900 Series fronts have full width integral pulls with enamel finish to match case fronts.

### Case Height Matrix

Interior Height		Exterior Height	
in.	mm	in.	mm
15"	381	17 7/8"	454
16 1/2"	419	19 3/8"	492
18"	457	20 7/8"	530
19 1/2"	495	22 3/8"	568
21"	533	23 7/8"	606
22 1/2"	572	25 3/8"	645
24"	610	26 7/8"	683
25 1/2"	648	28 3/8"	721
27"	686	29 7/8"	759
28 1/2"	724	31 3/8"	797
30"	762	32 7/8"	835
31 1/2"	800	34 3/8"	873
33"	838	35 7/8"	911
34 1/2"	876	37 3/8"	949
36"	914	38 7/8"	987
37 1/2"	953	40 3/8"	1026
39"	991	41 7/8"	1064
40 1/2"	1029	43 3/8"	1102
42"	1067	44 7/8"	1140
43 1/2"	1105	46 3/8"	1178
45"	1143	47 7/8"	1216
46 1/2"	1181	49 3/8"	1254
48"	1219	50 7/8"	1292
49 1/2"	1257	52 3/8"	1330
51"	1295	53 7/8"	1368
52 1/2"	1334	55 3/8"	1407
54"	1372	56 7/8"	1445
55 1/2"	1410	58 3/8"	1483
57"	1448	59 7/8"	1521
58 1/2"	1486	61 3/8"	1559
60"	1524	62 7/8"	1597
61 1/2"	1562	64 3/8"	1635
63"	1600	65 7/8"	1673
64 1/2"	1638	67 3/8"	1711
66"	1676	68 7/8"	1749
67 1/2"	1715	70 3/8"	1788
69"	1753	71 7/8"	1826
70 1/2"	1791	73 3/8"	1864
72"	1829	74 7/8"	1902
73 1/2"	1867	76 3/8"	1940
75"	1905	77 7/8"	1978
76 1/2"	1943	79 3/8"	2016

### How to order

1. Specify basic cabinet product number.
2. Specify cabinet interiors from TOP to BOTTOM.
3. Specify accessories, refer to Accessories section.
4. Specify finish color.
5. Cabinets come standard with lock. If lock is not required add suffix '**NL**' after product number. Deduct \$50 list

### Product code key example

#### 30-15E

- 30** cabinet width  
**15** cabinet interior clear height including tie bar  
**E** 9900 Series

### General information

$\frac{5}{8}$ " glides are standard and can be used with or without base aprons. Total of interior components specified must equal interior case height.  $1\frac{1}{2}$ " for structural tie bar must be added to interior components that total  $61\frac{1}{2}$ " or more.

#### Cabinets are 18" in depth.

Tie bar is not required:

- For 9900 Series if build-up includes hinged door insert, fixed shelf or SuperStor™ insert in the top opening.

**Note: Exterior cabinet heights shown above are nominal. Actual heights, with glides fully recessed, are  $\frac{1}{8}$ " less. Cabinets are 18" deep.**

**A standard  $1\frac{1}{2}$ " structural tie bar will be provided by the factory in all cabinets with  $64\frac{3}{8}$ " or more exterior height. The tie bar is usually positioned  $\pm 36$ " from the bottom of the cabinet.**

### Counterweights

Counterweights are required for ALL freestanding units that are not anchored or ganged to other cabinets or bolted to walls/floor. See Counterweight matrix on page 023.

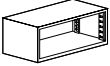
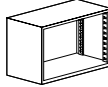
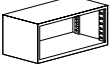
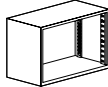
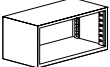
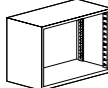
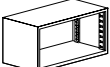
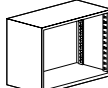
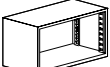
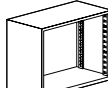
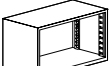
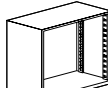
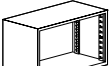
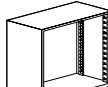
	Interior height	Exterior height	Part number	Neutral paint/ base price	Accent paint		Interior height	Exterior height	Part number	Neutral paint/ base price	Accent paint
	15"	17 $\frac{7}{8}$ "	<b>30-15E</b> <b>36-15E</b> <b>42-15E</b>	\$432 \$474 \$510	+\$45 +\$49 +\$52		25 $\frac{1}{2}$ "	28 $\frac{3}{8}$ "	<b>30-25.5E</b> <b>36-25.5E</b> <b>42-25.5E</b>	\$500 \$505 \$548	+\$51 +\$52 +\$56
	16 $\frac{1}{2}$ "	19 $\frac{3}{8}$ "	<b>30-16.5E</b> <b>36-16.5E</b> <b>42-16.5E</b>	\$445 \$483 \$512	+\$46 +\$50 +\$52		27"	29 $\frac{7}{8}$ "	<b>30-27E</b> <b>36-27E</b> <b>42-27E</b>	\$509 \$522 \$582	+\$52 +\$53 +\$59
	18"	20 $\frac{7}{8}$ "	<b>30-18E</b> <b>36-18E</b> <b>42-18E</b>	\$450 \$484 \$515	+\$46 +\$50 +\$53		28 $\frac{1}{2}$ "	31 $\frac{3}{8}$ "	<b>30-28.5E</b> <b>36-28.5E</b> <b>42-28.5E</b>	\$522 \$541 \$608	+\$53 +\$55 +\$62
	19 $\frac{1}{2}$ "	22 $\frac{3}{8}$ "	<b>30-19.5□</b> <b>36-19.5□</b> <b>42-19.5□</b>	\$452 \$485 \$522	+\$47 +\$50 +\$53		30"	32 $\frac{7}{8}$ "	<b>30-30E</b> <b>36-30E</b> <b>42-30E</b>	\$523 \$562 \$635	+\$53 +\$57 +\$64
	21"	23 $\frac{7}{8}$ "	<b>30-21E</b> <b>36-21E</b> <b>42-21E</b>	\$453 \$486 \$524	+\$47 +\$50 +\$53		31 $\frac{1}{2}$ "	34 $\frac{3}{8}$ "	<b>30-31.5□</b> <b>36-31.5□</b> <b>42-31.5□</b>	\$524 \$564 \$636	+\$53 +\$57 +\$64
	22 $\frac{1}{2}$ "	25 $\frac{3}{8}$ "	<b>30-22.5E</b> <b>36-22.5E</b> <b>42-22.5E</b>	\$455 \$488 \$527	+\$47 +\$50 +\$54		33"	35 $\frac{7}{8}$ "	<b>30-33E</b> <b>36-33E</b> <b>42-33E</b>	\$527 \$567 \$644	+\$54 +\$58 +\$65
	24"	26 $\frac{7}{8}$ "	<b>30-24E</b> <b>36-24E</b> <b>42-24E</b>	\$456 \$490 \$531	+\$47 +\$50 +\$54		34 $\frac{1}{2}$ "	37 $\frac{3}{8}$ "	<b>30-34.5E</b> <b>36-34.5E</b> <b>42-34.5E</b>	\$531 \$573 \$655	+\$54 +\$58 +\$66

# 9900 Series Laterals

## Build-Ups

Basic Lateral Cabinets

### How to order

1. Specify basic cabinet product number.
2. Specify cabinet interiors from TOP to BOTTOM.
3. Specify accessories, refer to Accessories section.
4. Specify finish color.
5. Cabinets come standard with lock. If lock is not required add suffix '**NL**' after product number. Deduct \$50 list

### Product code key example

#### 30-15E

- 30** cabinet width  
**15** cabinet interior clear height including tie bar  
**E** 9900 Series

### General information

$\frac{5}{8}$ " glides are standard and can be used with or without base aprons. Total of interior components specified must equal interior case height.  $1\frac{1}{2}$ " for structural tie bar must be added to interior components that total  $61\frac{1}{2}$ " or more.

#### Cabinets are 18" in depth.

Tie bar is not required:

- For 9900 Series if build-up includes hinged door insert, fixed shelf or SuperStor™ insert in the top opening.

**Note: Exterior cabinet heights shown above are nominal. Actual heights, with glides fully recessed, are  $\frac{1}{8}$ " less. Cabinets are 18" deep.**

**A standard  $1\frac{1}{2}$ " structural tie bar will be provided by the factory in all cabinets with  $64\frac{3}{8}$ " or more exterior height. The tie bar is usually positioned  $\pm 36$ " from the bottom of the cabinet.**

### Counterweights

Counterweights are required for ALL freestanding units that are not anchored or ganged to other cabinets or bolted to walls/floor. See Counterweight matrix on page 023.

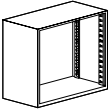
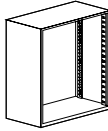
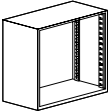
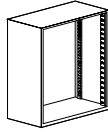
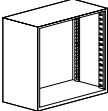
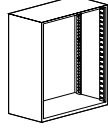
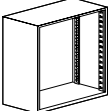
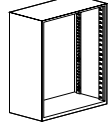
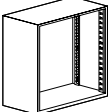
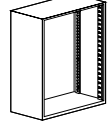
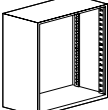
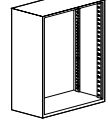
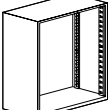
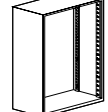
	Interior height	Exterior height	Part number	Neutral paint/ base price	Accent paint		Interior height	Exterior height	Part number	Neutral paint/ base price	Accent paint
	36"	38 $\frac{7}{8}$ "	<b>30-36E</b> <b>36-36E</b> <b>42-36E</b>	\$533 \$575 \$655	+\$54 +\$58 +\$66		46 $\frac{1}{2}$ "	49 $\frac{3}{8}$ "	<b>30-46.5E</b> <b>36-46.5E</b> <b>42-46.5E</b>	\$567 \$709 \$830	+\$58 +\$73 +\$85
	37 $\frac{1}{2}$ "	40 $\frac{3}{8}$ "	<b>30-37.5E</b> <b>36-37.5E</b> <b>42-37.5E</b>	\$542 \$595 \$684	+\$55 +\$60 +\$70		48"	50 $\frac{7}{8}$ "	<b>30-48E</b> <b>36-48E</b> <b>42-48E</b>	\$568 \$710 \$831	+\$58 +\$73 +\$85
	39"	41 $\frac{7}{8}$ "	<b>30-39E</b> <b>36-39E</b> <b>42-39E</b>	\$549 \$615 \$709	+\$56 +\$62 +\$73		49 $\frac{1}{2}$ "	52 $\frac{3}{8}$ "	<b>30-49.5E</b> <b>36-49.5E</b> <b>42-49.5E</b>	\$582 \$711 \$832	+\$59 +\$73 +\$85
	40 $\frac{1}{2}$ "	43 $\frac{3}{8}$ "	<b>30-40.5E</b> <b>36-40.5E</b> <b>42-40.5E</b>	\$556 \$640 \$740	+\$57 +\$65 +\$76		51"	53 $\frac{7}{8}$ "	<b>30-51E</b> <b>36-51E</b> <b>42-51E</b>	\$596 \$714 \$842	+\$60 +\$74 +\$86
	42"	44 $\frac{7}{8}$ "	<b>30-42E</b> <b>36-42E</b> <b>42-42E</b>	\$563 \$663 \$771	+\$57 +\$67 +\$79		52 $\frac{1}{2}$ "	55 $\frac{3}{8}$ "	<b>30-52.5E</b> <b>36-52.5E</b> <b>42-52.5E</b>	\$597 \$717 \$851	+\$60 +\$74 +\$87
	43 $\frac{1}{2}$ "	46 $\frac{3}{8}$ "	<b>30-43.5E</b> <b>36-43.5E</b> <b>42-43.5E</b>	\$564 \$688 \$804	+\$57 +\$70 +\$82		54"	56 $\frac{7}{8}$ "	<b>30-54E</b> <b>36-54E</b> <b>42-54E</b>	\$607 \$725 \$854	+\$61 +\$75 +\$87
	45"	47 $\frac{7}{8}$ "	<b>30-45E</b> <b>36-45E</b> <b>42-45E</b>	\$566 \$707 \$829	+\$57 +\$73 +\$85		55 $\frac{1}{2}$ "	58 $\frac{3}{8}$ "	<b>30-55.5E</b> <b>36-55.5E</b> <b>42-55.5E</b>	\$608 \$730 \$864	+\$62 +\$75 +\$88

### How to order

1. Specify basic cabinet product number.
2. Specify cabinet interiors from TOP to BOTTOM.
3. Specify accessories, refer to Accessories section.
4. Specify finish color.
5. Cabinets come standard with lock. If lock is not required add suffix **'NL'** after product number. Deduct \$50 list

### Product code key example

#### 30-15E

- 30** cabinet width  
**15** cabinet interior clear height including tie bar  
**E** 9900 Series

### General information

5/8" glides are standard and can be used with or without base aprons. Total of interior components specified must equal interior case height. 1 1/2" for structural tie bar must be added to interior components that total 61 1/2" or more.

#### Cabinets are 18" in depth.

Tie bar is not required:



- For 9900 Series if build-up includes hinged door insert, fixed shelf or SuperStor™ insert in the top opening.

**Note: Exterior cabinet heights shown above are nominal. Actual heights, with glides fully recessed, are 1/8" less. Cabinets are 18" deep.**

**A standard 1 1/2" structural tie bar will be provided by the factory in all cabinets with 64 3/8" or more exterior height. The tie bar is usually positioned ±36" from the bottom of the cabinet.**

### Counterweights

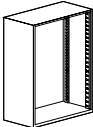
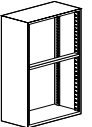
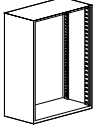
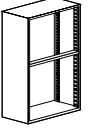
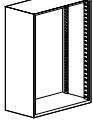
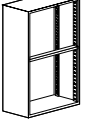
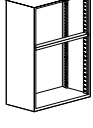
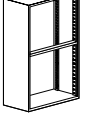
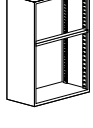
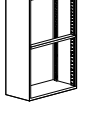
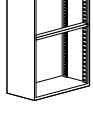
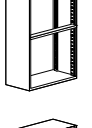
Counterweights are required for ALL freestanding units that are not anchored or ganged to other cabinets or bolted to walls/floor. See Counterweight matrix on page <?>.

	Interior height	Exterior height	Part number	Neutral paint/ base price	Accent paint		Interior height	Exterior height	Part number	Neutral paint/ base price	Accent paint
	57"	59 7/8"	<b>30-57E</b> <b>36-57E</b> <b>42-57E</b>	\$611 \$737 \$871	+\$62 +\$76 +\$89		67 1/2"	70 3/8"	<b>30-67.5E</b> <b>36-67.5E</b> <b>42-67.5E</b>	\$696 \$837 \$970	+\$72 +\$85 +\$98
	58 1/2"	61 3/8"	<b>30-58.5E</b> <b>36-58.5E</b> <b>42-58.5E</b>	\$612 \$738 \$872	+\$62 +\$76 +\$89		69"	71 7/8"	<b>30-69E</b> <b>36-69E</b> <b>42-69E</b>	\$713 \$864 \$997	+\$74 +\$88 +\$101
	60"	62 7/8"	<b>30-60E</b> <b>36-60E</b> <b>42-60E</b>	\$614 \$739 \$873	+\$62 +\$76 +\$89		70 1/2"	73 3/8"	<b>30-70.5E</b> <b>36-70.5E</b> <b>42-70.5E</b>	\$738 \$888 \$1026	+\$76 +\$90 +\$105
	61 1/2"	64 3/8"	<b>30-61.5E</b> <b>36-61.5E</b> <b>42-61.5E</b>	\$615 \$740 \$874	+\$62 +\$76 +\$89		72"	74 7/8"	<b>30-72□</b> <b>36-72□</b> <b>42-72□</b>	\$766 \$917 \$1049	+\$79 +\$93 +\$107
	63"	65 7/8"	<b>30-63E</b> <b>36-63E</b> <b>42-63E</b>	\$633 \$765 \$895	+\$64 +\$79 +\$91		73 1/2"	76 3/8"	<b>30-73.5E</b> <b>36-73.5E</b> <b>42-73.5E</b>	\$786 \$944 \$1084	+\$81 +\$96 +\$110
	64 1/2"	67 3/8"	<b>30-64.5E</b> <b>36-64.5E</b> <b>42-64.5E</b>	\$649 \$786 \$920	+\$65 +\$81 +\$93		75"	77 7/8"	<b>30-75E</b> <b>36-75E</b> <b>42-75E</b>	\$821 \$975 \$1111	+\$84 +\$99 +\$113
	66"	68 7/8"	<b>30-66E</b> <b>36-66E</b> <b>42-66E</b>	\$669 \$814 \$943	+\$67 +\$83 +\$96		76 1/2"	79 3/8"	<b>30-76.5E</b> <b>36-76.5E</b>	\$852 \$1004	+\$87 +\$101



# 9900 Series Laterals

## Build-Ups

Basic Lateral Cabinets with Security Lock Bar

### How to order

1. Specify basic cabinet product number.
2. Specify cabinet interiors from TOP to BOTTOM ensuring that the total height of the selected components equals the total interior clear height of the case.
3. Specify accessories, refer to Accessories section.
4. Specify finish color.
5. Cabinets come standard with lock. If lock is not required add suffix 'NL' after product number. Deduct \$50 list.

### Product Code Key Example

#### 30-63ESB

<b>30</b>	cabinet width
<b>63</b>	cabinet interior clear height including sliding security bar
<b>E</b>	9900 Series
<b>SB</b>	sliding security bar

### Finishes

Refer to Finishes section for color options. Sliding security bar and hinges are the same finish as the case. Drawer bodies and accessories are finished in Eco Black.

### Important

These are available in Storage Centers and 9900 Series only. Security lock bars cannot be field installed. Tie bar, filler panel, hinged door inserts and SuperStor™ inserts cannot be specified as cabinet interiors. Reference shelf cannot be positioned above or below the security bar.

The security lock base 1 1/2" high.

**Note: Exterior cabinet heights shown are nominal. Actual heights, with glides fully recessed, are 1/8" less. Cabinets are 18" deep.**

**Cabinets come with piano style hinges, a 1 1/2" sliding security bar and a lock hook with double sided tape.**

### Counterweights

Counterweights are required for ALL freestanding units that are not anchored or ganged to other cabinets or bolted to walls/floor. See Counterweight matrix on page 023.

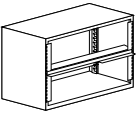
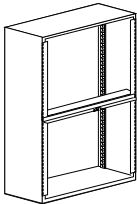
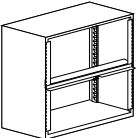
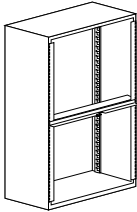
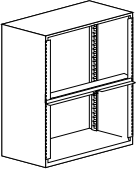
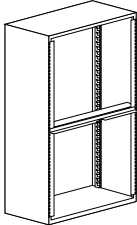
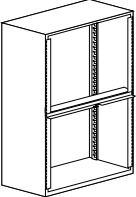
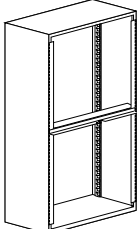
	Interior height	Exterior height	Part number	Neutral paint/ base price	Accent paint		Interior height	Exterior height	Part number	Neutral paint/ base price	Accent paint
	25 1/2"	25 3/8"	<b>30-25.5ESB</b> <b>36-25.5ESB</b> <b>42-25.5ESB</b>	\$775 \$780 \$823	+\$79 +\$80 +\$84		63"	65 7/8"	<b>30-63ESB</b> <b>36-63ESB</b> <b>42-63ESB</b>	\$1000 \$1131 \$1261	+\$101 +\$115 +\$127
	37 1/2"	40 3/8"	<b>30-37.5ESB</b> <b>36-37.5ESB</b> <b>42-37.5ESB</b>	\$850 \$903 \$992	+\$87 +\$92 +\$100		67 1/2"	70 3/8"	<b>30-67.5ESB</b> <b>36-67.5ESB</b> <b>42-67.5ESB</b>	\$1071 \$1212 \$1345	+\$109 +\$122 +\$135
	49 1/2"	52 3/8"	<b>30-49.5ESB</b> <b>36-49.5ESB</b> <b>42-49.5ESB</b>	\$919 \$1048 \$1169	+\$93 +\$107 +\$118		73 1/2"	76 3/8"	<b>30-73.5ESB</b> <b>36-73.5ESB</b> <b>42-73.5ESB</b>	\$1175 \$1332 \$1472	+\$119 +\$134 +\$149
	61 1/2"	64 3/8"	<b>30-61.5ESB</b> <b>36-61.5ESB</b> <b>42-61.5ESB</b>	\$978 \$1103 \$1236	+\$99 +\$112 +\$125		76 1/2"	79 3/8"	<b>30-76.5ESB</b> <b>36-76.5ESB</b>	\$1253 \$1404	+\$126 +\$143

# 9900 Series Laterals

## Build-Ups

Cabinet Interiors

Interior Drawers with Accessories

### How to order

- Specify basic cabinet product number followed by drawer and shelf interiors with their accessories (see Accessories section) in order from TOP to BOTTOM, indicating which interior is in the top position. Interiors may be specified in almost any combination to make up the TOTAL INTERIOR HEIGHT.
- Specify finish color

### Product code key example

**10.5FFE-36HF**

**10.5** module height  
**FF** fixed front drawer  
**LU/PS** lift-up w/pullout shelf  
**E** 9900 Series  
**36** width  
**HF** hangfile bar  
**HFSR** hangfile bars w/sliding rails

### General information

The following cabinet interiors contain all necessary accessories to accommodate the media shown.

### Finishes

Refer to Finishes section for color options. Drawer bodies and accessories are finished in Eco Black.

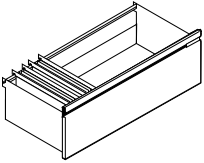
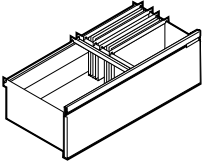
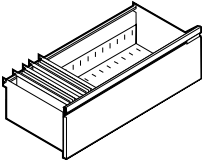
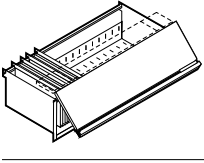
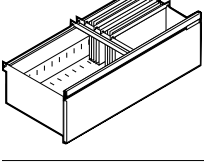
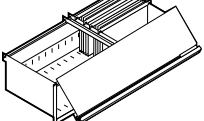
Description	Part number	Exterior height	Width	Weight (lbs)	9900 series/ Neutral paint	Accent paint
 <p>10.5" fixed front pullout drawer with 1 pair hangfile bars for filing side-to-side. Note: Not to be used for bottom filing.</p>	<b>10.5FFE-30HF</b>	10.5"	30"	16	\$266	+\$28
	<b>10.5FFE-36HF</b>	10.5"	36"	20	\$297	+\$31
	<b>10.5FFE-42HF</b>	10.5"	42"	24	\$329	+\$34
 <p>10.5" fixed front pullout drawer with 1 pair hangfile bars and 2 sliding rails for filing front-to-back. Note: Not to be used for bottom filing.</p>	<b>10.5FF E-30HFSR</b>	10.5"	30"	17	\$291	+\$29
	<b>10.5FF E-36HFSR</b>	10.5"	36"	21	\$322	+\$32
	<b>10.5FF E-42HFSR</b>	10.5"	42"	25	\$354	+\$36
 <p>12" fixed front pullout drawer with 1 pair hangfile bars for filing side-to-side</p>	<b>12FFE-30HF</b>	12"	30"	17	\$266	+\$28
	<b>12FFE-36HF</b>	12"	36"	21	\$297	+\$31
	<b>12FFE-42HF</b>	12"	42"	25	\$329	+\$34
 <p>12" lift-up door with pullout shelf and 1 pair hangfile bars for filing side-to-side</p>	<b>12LUE/PS-30HF</b>	12"	30"	22	\$266	+\$28
	<b>12LUE/PS-36HF</b>	12"	36"	27	\$297	+\$31
	<b>12LUE/PS-42HF</b>	12"	42"	33	\$329	+\$34
 <p>12" fixed front pullout drawer with 1 pair hangfile bars and 2 sliding rails for filing front-to-back</p>	<b>12FFE-30HFSR</b>	12"	30"	18	\$291	+\$29
	<b>12FFE-36HFSR</b>	12"	36"	22	\$322	+\$32
	<b>12FFE-42HFSR</b>	12"	42"	26	\$354	+\$36
 <p>12" lift-up door with pullout shelf 1 pair hangfile bars and 2 sliding rails for filing front-to-back</p>	<b>12LUE/PS-30HFSR</b>	12"	30"	23	\$291	+\$29
	<b>12LUE/PS-36HFSR</b>	12"	36"	28	\$322	+\$32
	<b>12LUE/PS-42HFSR</b>	12"	42"	34	\$354	+\$36



# 9900 Series Laterals

## Build-Ups

### Cabinet Interiors

#### Interior Drawers with Accessories

#### How to order

- Specify basic cabinet product number followed by drawer and shelf interiors with their accessories (see Accessories section) in order from TOP to BOTTOM, indicating which interior is in the top position. Interiors may be specified in almost any combination to make up the TOTAL INTERIOR HEIGHT.
- Specify finish color

#### Product code key example

##### 12LUE/FS-36DV

<b>12</b>	module height
<b>LU/PS</b>	lift-up w/pullout shelf
<b>LU/FS</b>	lift-up w/fixed shelf
<b>E</b>	9900 Series
<b>36</b>	width
<b>DV</b>	plate dividers
<b>LDV</b>	legal/letter adapter w/plate dividers

#### General information

The following cabinet interiors contain all necessary accessories to accommodate the media shown.

#### Finishes

Refer to Finishes section for color options. Drawer bodies and accessories are finished in Eco Black.

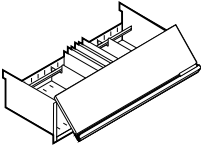
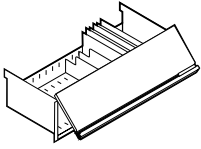
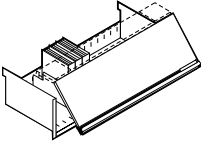
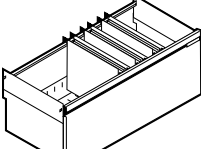
Description	Part number	Exterior height	Width	Weight (lbs)	9900 series/ Neutral paint	Accent paint
 <p>letter depth 12" lift-up door with fixed shelf, legal to letter adapter and 3 plate dividers</p>	<b>12LUE/FS-30LDV</b>	12"	30"	23	\$293	+\$30
	<b>12LUE/FS-36LDV</b>	12"	36"	27	\$317	+\$32
	<b>12LUE/FS-42LDV</b>	12"	42"	33	\$352	+\$37
 <p>legal depth 12" lift-up door with fixed shelf and 3 plate dividers</p>	<b>12LUE/FS-30DV</b>	12"	30"	23	\$271	+\$28
	<b>12LUE/FS-36DV</b>	12"	36"	27	\$295	+\$30
	<b>12LUE/FS-42DV</b>	12"	42"	33	\$330	+\$34
 <p>12" lift-up door with pullout shelf and 3 plate dividers</p>	<b>12LUE/PS-30DV</b>	12"	30"	23	\$281	+\$29
	<b>12LUE/PS-36DV</b>	12"	36"	27	\$312	+\$32
	<b>12LUE/PS-42DV</b>	12"	42"	33	\$343	+\$36
 <p>13.5" lift-up door with fixed shelf and 3 plate dividers</p>	<b>13.5LUE/FS-30DV</b>	13.5"	30"	24	\$281	+\$29
	<b>13.5LUE/FS-36DV</b>	13.5"	36"	28	\$318	+\$33
	<b>13.5LUE/FS-42DV</b>	13.5"	42"	34	\$361	+\$38
 <p>13.5" lift-up drawer with pullout shelf and 1 pair of hang-file bars for side-to-side filing</p>	<b>13.5LUE/PS-30HF</b>	13.5"	30"	23	\$301	+\$31
	<b>13.5LUE/PS-36HF</b>	13.5"	36"	28	\$340	+\$36
	<b>13.5LUE/PS-42HF</b>	13.5"	42"	33	\$373	+\$39
 <p>13.5" lift-up door with pullout shelf and 3 plate dividers</p>	<b>13.5LU□/PS-30DV</b>	13.5"	30"	24	\$316	+\$32
	<b>13.5LU□/PS-36DV</b>	13.5"	36"	28	\$355	+\$37
	<b>13.5LU□/PS-42DV</b>	13.5"	42"	33	\$388	+\$40
 <p>13.5" fixed front drawer with EDP kit for filing side-to-side</p>	<b>13.5FFE-30EDP</b>	13.5"	30"	21	\$334	+\$34
	<b>13.5FFE-36EDP</b>	13.5"	36"	25	\$373	+\$39
	<b>13.5FFE-42EDP</b>	13.5"	42"	30	\$406	+\$42

# 9900 Series Laterals

## Build-Ups Cabinet Interiors

Interior Drawers with Accessories

### How to order

- Specify basic cabinet product number followed by drawer and shelf interiors with their accessories (see Accessories section) in order from TOP to BOTTOM, indicating which interior is in the top position. Interiors may be specified in almost any combination to make up the TOTAL INTERIOR HEIGHT.
- Specify finish color

### Product code key example **12FFE-36EDPSR**

**12** module height  
**FF** fixed front drawer  
**E** 9900 Series **36** width  
**EDPSR** EDP kit w/sliding rails  
**TS** tape seal center hang bar

### General information

The following cabinet interiors contain all necessary accessories to accommodate the media shown.

### Finishes

Refer to Finishes section for color options. Drawer bodies and accessories are finished in Eco Black.

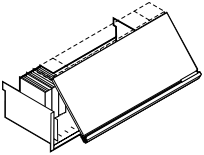
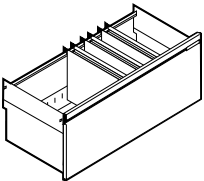
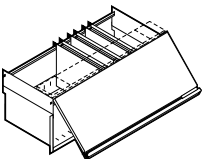
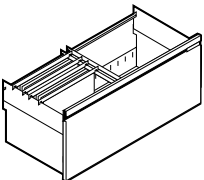
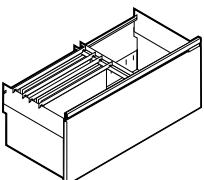
Description	Part number	Exterior height	Width	Weight (lbs)	9900 series/ Neutral paint	Accent paint
 <p>15" lift-up door with fixed shelf and 3 plate dividers</p>	<b>15LUE/FS-30DV</b>	15"	30"	25	\$281	+\$29
	<b>15LUE/FS-36DV</b>	15"	36"	29	\$318	+\$33
	<b>15LUE/FS-42DV</b>	15"	42"	35	\$361	+\$38
 <p>15" fixed front drawer with EDP kit for filing side-to-side</p>	<b>15FFE-30EDP</b>	15"	30"	22	\$334	+\$34
	<b>15FFE-36EDP</b>	15"	36"	25	\$373	+\$39
	<b>15FFE-42EDP</b>	15"	42"	30	\$406	+\$42
 <p>15" lift-up door with pullout shelf and EDP kit for filing side-to-side</p>	<b>15LUE/PS-30EDP</b>	15"	30"	27	\$334	+\$34
	<b>15LUE/PS-36EDP</b>	15"	36"	31	\$373	+\$39
	<b>15LUE/PS-42EDP</b>	15"	42"	36	\$406	+\$42
 <p>15" fixed front drawer with EDP kit and sliding rails (2 in 30" - 3 in 36" and 42"w) for front-to-back filing</p>	<b>15FFE-30EDPSR</b>	15"	30"	23	\$359	+\$36
	<b>15FFE-36EDPSR</b>	15"	36"	26	\$410	+\$40
	<b>15FFE-42EDPSR</b>	15"	42"	32	\$443	+\$43
 <p>16.5" fixed front drawer with X-ray EDP Kit and sliding rails (1 in 30" and 36", 2 in 42") for front-to-back filing</p>	<b>16.5FFE-30XRAY</b>	16.5"	30"	19	\$389	+\$40
	<b>16.5FFE-36XRAY</b>	16.5"	36"	23	\$418	+\$43
	<b>16.5FFE-42XRAY</b>	16.5"	42"	30	\$471	+\$48

# 9900 Series Laterals

## Build-Ups

### Cabinet Interiors

#### Hinged Door Cabinet Inserts with Accessories

#### How to order

1. Specify basic cabinet product number followed by drawer and shelf interiors with their accessories (see Accessories section) in order from TOP to BOTTOM, indicating which interior is in the top position. Interiors may be specified in almost any combination to make up the TOTAL INTERIOR HEIGHT.
2. Specify finish color

#### Product code key example

##### 24HDE/SH-36DV

<b>24</b>	module height
<b>HD</b>	hinged door
<b>E</b>	9900 Series
<b>SH</b>	shelf
<b>36</b>	width
<b>DV</b>	plate dividers

#### Lock option

Hinged door inserts come standard with lock. If lock is not required add suffix 'NL' after product number. Deduct \$50 list.

#### Finishes

Refer to Finishes section for color options. Drawer bodies and accessories are finished in Eco Black.

#### General information

The following cabinet interiors contain all necessary accessories to accommodate the media shown.

A hinged door insert includes a bottom shelf. This means that the insert door height and usable interior space is actually 1 1/2" less than the heights noted in the descriptions.

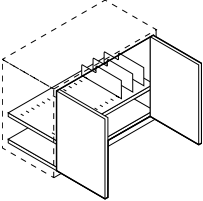
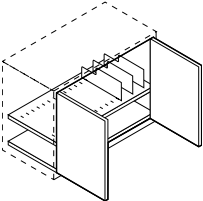
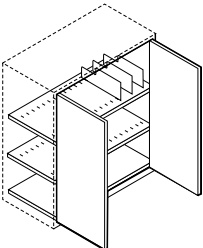
Description	Part number	Exterior height	Width	Weight (lbs)	9900 series/ Neutral paint	Accent paint
 <p>24" hinged door cupboard insert with 1 adjustable slotted shelf and 3 plate dividers. Bottom shelf is standard with slots. Must be specified in the top opening.</p>	<b>24HDE/SH-30DV</b>	24"	30"	36	\$581	+\$59
	<b>24HDE/SH-36DV</b>	24"	36"	50	\$617	+\$62
	<b>24HDE/SH-42DV</b>	24"	42"	64	\$703	+\$72
 <p>27" hinged door cupboard insert with 1 adjustable slotted shelf and 3 plate dividers. Bottom shelf is standard with slots. Must be specified in the top opening.</p>	<b>27HDE/SH-30DV</b>	27"	30"	38	\$581	+\$59
	<b>27HDE/SH-36DV</b>	27"	36"	52	\$617	+\$62
	<b>27HDE/SH-42DV</b>	27"	42"	62	\$703	+\$72
 <p>39" hinged door cupboard insert with 2 adjustable slotted shelf and 3 plate dividers. Will accommodate 3 rows of standard binders. Bottom shelf is standard with slots. Must be specified in the top opening.</p>	<b>39HDE/SH-30DV</b>	39"	30"	52	\$640	+\$64
	<b>39HDE/SH-36DV</b>	39"	36"	78	\$676	+\$68
	<b>39HDE/SH-42DV</b>	39"	42"	93	\$758	+\$78

# 9900 Series Laterals

**Build-Ups**  
Cabinet Interiors  
Drawer and Shelf Interiors

## How to order

- Specify basic cabinet product number followed by drawer and shelf interiors with their accessories (see Accessories section) in order from TOP to BOTTOM, indicating which interior is in the top position. Interiors may be specified in almost any combination to make up the TOTAL INTERIOR HEIGHT.
- Specify finish color

## Product code key example

**7.5FFE-36**

**7.5** module height  
**FF** fixed front drawer  
**E** 9900 Series  
**36** width

## General information

Drawers and shelf interiors on these pages do not include accessories. For drawers with accessories see complete media modules preceding this section. See Lateral File Accessories section for accessories.

## Finishes

Refer to Finishes section for color options. Drawer bodies and accessories are finished in Eco Black.

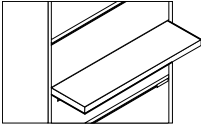
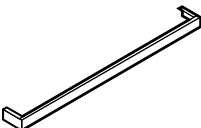
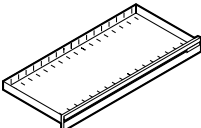
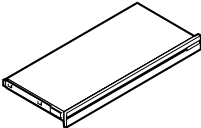
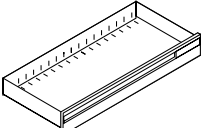
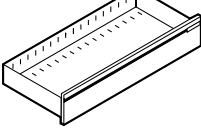
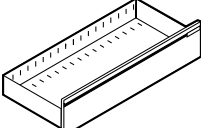
Description	Part number	Exterior height	Width	Weight (lbs)	9900 series/ Neutral paint	Accent paint
 <p>1.5" Opening Interiors 1.5" reference shelf (can replace tie bar in units designated with tie bar) Cannot be positioned in top opening, or below hinged door inserts</p>	<b>RF-30</b>	1.5"	30"	8	\$124	+\$14
	<b>RF-36</b>	1.5"	36"	10	\$126	+\$14
	<b>RF-42</b>	1.5"	42"	12	\$129	+\$15
 <p>1.5" filler panel Cannot be positioned above or below a reference shelf.</p>	<b>1.5F-30</b>	1.5"	30"	1	\$57	+\$8
	<b>1.5F-36</b>	1.5"	36"	1	\$61	+\$8
	<b>1.5F-42</b>	1.5"	42"	1	\$63	+\$8
 <p>3" Opening Interiors 3" fixed front drawer Note: 3" drawer, when located immediately above a case bottom, tie bar or reference shelf cannot be locked.</p>	<b>3FFE-30</b>	3"	30"	10	\$192	+\$21
	<b>3FFE-36</b>	3"	36"	12	\$202	+\$22
	<b>3FFE-42</b>	3"	42"	14	\$204	+\$22
 <p>3" fixed front drawer with laminate shelf Note: 3" drawer, when located immediately above a case bottom, tie bar or reference shelf cannot be locked.</p>	<b>3FFE/PL-30</b>	3"	30"	26	\$388	+\$40
	<b>3FFE/PL-36</b>	3"	36"	32	\$402	+\$42
	<b>3FFE/PL-42</b>	3"	42"	39	\$445	+\$46
 <p>4.5" Opening Interiors 4.5" fixed front drawer</p>	<b>4.5FFE-30</b>	4.5"	30"	10	\$192	+\$21
	<b>4.5FFE-36</b>	4.5"	36"	12	\$202	+\$22
	<b>4.5FFE-42</b>	4.5"	42"	14	\$204	+\$22
 <p>6" Opening Interiors 6" fixed front drawer. Optional drawer filler is recommended. See Lateral Accessories.</p>	<b>6FFE-30</b>	6"	30"	12	\$202	+\$22
	<b>6FFE-36</b>	6"	36"	16	\$227	+\$24
	<b>6FFE-42</b>	6"	42"	17	\$252	+\$26
 <p>7.5" Opening Interiors 7.5" fixed front drawer. Optional drawer filler is recommended. See Lateral Accessories.</p>	<b>7.5FFE-30</b>	7.5"	30"	13	\$225	+\$24
	<b>7.5FFE-36</b>	7.5"	36"	17	\$250	+\$26
	<b>7.5FFE-42</b>	7.5"	42"	18	\$279	+\$29

# 9900 Series Laterals

## Build-Ups

Cabinet Interiors

Drawer and Shelf Interiors

### How to order

1. Specify basic cabinet product number followed by drawer and shelf interiors with their accessories (see Accessories section) in order from TOP to BOTTOM, indicating which interior is in the top position. Interiors may be specified in almost any combination to make up the TOTAL INTERIOR HEIGHT.
2. Specify finish color

### Product code key example

**9FFE-36**

**9** module height  
**FF** fixed front drawer  
**E** 9900 Series  
**36** width

### General information

Drawers and shelf interiors on these pages do not include accessories. For drawers with accessories see complete media modules preceding this section. See Lateral File Accessories section for accessories.

### Finishes

Refer to Finishes section for color options. Drawer bodies and accessories are finished in Eco Black.

Description	Part number	Exterior height	Width	Weight (lbs)	9900 series/ Neutral paint	Accent paint
 <p>9" Opening Interiors 9" fixed front drawer</p>	<b>9FFE-30</b>	9"	30"	14	\$225	+\$24
	<b>9FFE-36</b>	9"	36"	17	\$250	+\$26
	<b>9FFE-42</b>	9"	42"	19	\$279	+\$29
 <p>10.5" Opening Interiors 10.5" fixed front drawer</p>	<b>10.5FFE-30</b>	10.5"	30"	14	\$228	+\$24
	<b>10.5FFE-36</b>	10.5"	36"	17	\$259	+\$27
	<b>10.5FFE-42</b>	10.5"	42"	19	\$291	+\$30
 <p>10.5" Opening Interiors 10.5" fixed front drawer to accommodate non-suspended filing. Note: Not to be used with hangfile bars.</p>	<b>10.5FFE-30BF</b>	10.5"	30"	14	\$228	+\$24
	<b>10.5FFE-36BF</b>	10.5"	36"	17	\$259	+\$27
	<b>10.5FFE-42BF</b>	10.5"	42"	20	\$291	+\$30
 <p>10.5" slotted bottom fixed front drawer with raised back. Note: Not to be used with hangfile bars.</p>	<b>10.5FFE-30BFRB</b>	10.5"	30"	14	\$248	+\$26
	<b>10.5FFE-36BFRB</b>	10.5"	36"	17	\$281	+\$29
	<b>10.5FFE-42BFRB</b>	10.5"	42"	20	\$314	+\$32
 <p>12" Opening Interiors 12" fixed front drawer</p>	<b>12FFE-30</b>	12"	30"	15	\$228	+\$24
	<b>12FFE-36</b>	12"	36"	18	\$259	+\$27
	<b>12FFE-42</b>	12"	42"	21	\$291	+\$30
 <p>12" fixed front drawer with raised back</p>	<b>12FFE-30RB</b>	12"	30"	15	\$248	+\$26
	<b>12FFE-36RB</b>	12"	36"	18	\$281	+\$29
	<b>12FFE-42RB</b>	12"	42"	21	\$314	+\$32

# 9900 Series Laterals

**Build-Ups**  
Cabinet Interiors  
Drawer and Shelf Interiors

## How to order

- Specify basic cabinet product number followed by drawer and shelf interiors with their accessories (see Accessories section) in order from TOP to BOTTOM, indicating which interior is in the top position. Interiors may be specified in almost any combination to make up the TOTAL INTERIOR HEIGHT.
- Specify finish color

## Product code key example

**12LUE/FS-36**

**12** module height  
**LU** lift-up  
**E** 9900 Series  
**FS** fixed shelf  
**36** width

## General information

Drawers and shelf interiors on these pages do not include accessories. For drawers with accessories see complete media modules preceding this section. See Lateral File Accessories section for accessories.

## Finishes

Refer to Finishes section for color options. Drawer bodies and accessories are finished in Eco Black.

Description	Part number	Exterior height	Width	Weight (lbs)	9900 series/ Neutral paint	Accent paint
	<b>12LUE/PS-30</b>	12"	30"	20	\$228	+\$24
	<b>12LUE/PS-36</b>	12"	36"	24	\$259	+\$27
	<b>12LUE/PS-42</b>	12"	42"	29	\$291	+\$30
	<b>12LU□/PS-30RB</b>	12"	30"	20	\$248	+\$26
	<b>12LU□/PS-36RB</b>	12"	36"	24	\$281	+\$29
	<b>12LU□/PS-42RB</b>	12"	42"	29	\$314	+\$32
	<b>12LUE/FS-30</b>	12"	30"	19	\$219	+\$23
	<b>12LUE/FS-36</b>	12"	36"	22	\$243	+\$26
	<b>12LUE/FS-42</b>	12"	42"	27	\$278	+\$29
	<b>12LUE/FS-30RB</b>	12"	30"	19	\$236	+\$25
	<b>12LUE/FS-36RB</b>	12"	36"	22	\$263	+\$28
	<b>12LUE/FS-42RB</b>	12"	42"	27	\$301	+\$31
	<b>12LUE-30</b>	12"	30"	11	\$111	+\$13
	<b>12LUE-36</b>	12"	36"	14	\$129	+\$15
	<b>12LUE-42</b>	12"	42"	17	\$147	+\$16
	<b>12LUE/PL-30</b>	12"	30"	35	\$498	+\$51
	<b>12LUE/PL-36</b>	12"	36"	44	\$547	+\$56
	<b>12LUE/PL-42</b>	12"	42"	52	\$599	+\$61
	<b>12LUE/66PS-30</b>	12"	30"	22	\$386	+\$40
	<b>12LUE/66PS-36</b>	12"	36"	27	\$418	+\$43
	<b>12LUE/66PS-42</b>	12"	42"	33	\$458	+\$47

# 9900 Series Laterals

## Build-Ups

Cabinet Interiors

Drawer and Shelf Interiors

### How to order

- Specify basic cabinet product number followed by drawer and shelf interiors with their accessories (see Accessories section) in order from TOP to BOTTOM, indicating which interior is in the top position. Interiors may be specified in almost any combination to make up the TOTAL INTERIOR HEIGHT.
- Specify finish color

### Product code key example

**13.5FFE-30RB**

**13.5** module height  
**FF** fixed front  
**E** 9900 Series  
**36** width  
**RB** raised back

### General information

Drawers and shelf interiors on these pages do not include accessories. For drawers with accessories see complete media modules preceding this section. See Lateral File Accessories section for accessories.

### Finishes

Refer to Finishes section for color options. Drawer bodies and accessories are finished in Eco Black.

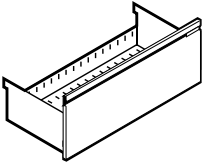
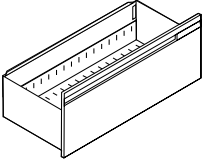
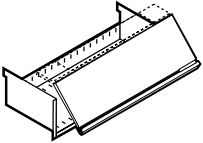
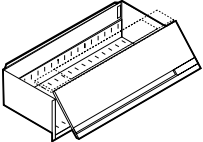
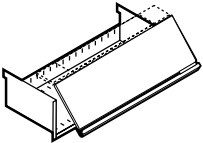
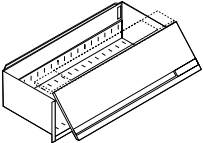
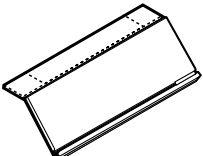
Description	Part number	Exterior height	Width	Weight (lbs)	9900 series/ Neutral paint	Accent paint
 13.5" Opening Interiors 13.5" fixed front drawer	<b>13.5FFE-30</b>	13.5"	30"	16	\$263	+\$28
	<b>13.5FFE-36</b>	13.5"	36"	19	\$302	+\$31
	<b>13.5FFE-42</b>	13.5"	42"	22	\$335	+\$34
 13.5" fixed front drawer with raised back	<b>13.5FFE-30RB</b>	13.5"	30"	16	\$284	+\$29
	<b>13.5FFE-36RB</b>	13.5"	36"	19	\$321	+\$33
	<b>13.5FFE-42RB</b>	13.5"	42"	22	\$358	+\$38
 13.5" lift-up door with pullout shelf	<b>13.5LUE/PS-30</b>	13.5"	30"	21	\$263	+\$28
	<b>13.5LUE/PS-36</b>	13.5"	36"	25	\$302	+\$31
	<b>13.5LUE/PS-42</b>	13.5"	42"	29	\$335	+\$34
 13.5" lift-up door with pullout shelf with raised back	<b>13.5LUE/PS-30RB</b>	13.5"	30"	21	\$284	+\$29
	<b>13.5LUE/PS-36RB</b>	13.5"	36"	25	\$321	+\$33
	<b>13.5LUE/PS-42RB</b>	13.5"	42"	29	\$358	+\$38
 13.5" lift-up door with fixed shelf	<b>13.5LUE/FS-30</b>	13.5"	30"	20	\$228	+\$24
	<b>13.5LUE/FS-36</b>	13.5"	36"	23	\$265	+\$28
	<b>13.5LUE/FS-42</b>	13.5"	42"	27	\$308	+\$32
 13.5" lift-up door with fixed shelf with raised back	<b>13.5LUE/FS-30RB</b>	13.5"	30"	20	\$248	+\$26
	<b>13.5LUE/FS-36RB</b>	13.5"	36"	23	\$287	+\$30
	<b>13.5LUE/FS-42RB</b>	13.5"	42"	27	\$330	+\$34
 13.5" lift-up door	<b>13.5LUE-30</b>	13.5"	30"	12	\$145	+\$16
	<b>13.5LUE-36</b>	13.5"	36"	15	\$177	+\$19
	<b>13.5LUE-42</b>	13.5"	42"	18	\$197	+\$21

# 9900 Series Laterals

**Build-Ups**  
Cabinet Interiors  
Drawer and Shelf Interiors

## How to order

- Specify basic cabinet product number followed by drawer and shelf interiors with their accessories (see Accessories section) in order from TOP to BOTTOM, indicating which interior is in the top position. Interiors may be specified in almost any combination to make up the TOTAL INTERIOR HEIGHT.
- Specify finish color

## Product code key example

**15LUE/PS-36**

**15** module height  
**LU** lift-up  
**E** 9900 Series  
**PS** pull out shelf  
**36** width

## General information

Drawers and shelf interiors on these pages do not include accessories. For drawers with accessories see complete media modules preceding this section. See Lateral File Accessories section for accessories.

## Finishes

Refer to Finishes section for color options. Drawer bodies and accessories are finished in Eco Black.

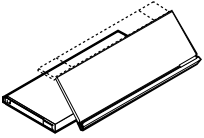
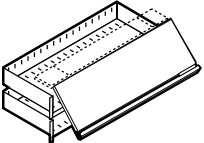
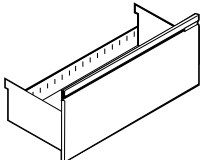
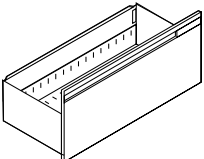
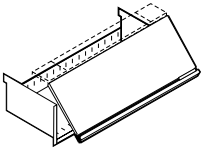
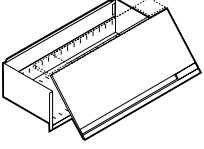
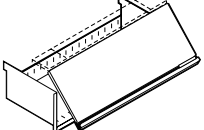
Description	Part number	Exterior height	Width	Weight (lbs)	9900 series/ Neutral paint	Accent paint
	<b>13.5LUE/PL-30</b>	13.5"	30"	36	\$498	+\$51
	<b>13.5LUE/PL-36</b>	13.5"	36"	45	\$547	+\$56
	<b>13.5LUE/PL-42</b>	13.5"	42"	54	\$599	+\$61
	<b>13.5LUE/66PS-30</b>	13.5"	30"	23	\$418	+\$43
	<b>13.5LUE/66PS-36</b>	13.5"	36"	28	\$453	+\$47
	<b>13.5LUE/66PS-42</b>	13.5"	42"	33	\$498	+\$51
	<b>15FFE-30</b>	15"	30"	16	\$263	+\$28
	<b>15FFE-36</b>	15"	36"	19	\$302	+\$31
	<b>15FFE-42</b>	15"	42"	23	\$335	+\$34
	<b>15FFE-30RB</b>	15"	30"	16	\$284	+\$29
	<b>15FFE-36RB</b>	15"	36"	19	\$321	+\$33
	<b>15FFE-42RB</b>	15"	42"	23	\$358	+\$38
	<b>15LUE/PS-30</b>	15"	30"	21	\$263	+\$28
	<b>15LUE/PS-36</b>	15"	42"	29	\$302	+\$31
	<b>15LUE/PS-42</b>	15"	42"	29	\$335	+\$34
	<b>15LUE/PS-30RB</b>	15"	30"	21	\$284	+\$29
	<b>15LUE/PS-36RB</b>	15"	36"	25	\$321	+\$33
	<b>15LUE/PS-42RB</b>	15"	42"	29	\$358	+\$38
	<b>15LUE/FS-30</b>	15"	30"	20	\$228	+\$24
	<b>15LUE/FS-36</b>	15"	36"	23	\$265	+\$28
	<b>15LUE/FS-42</b>	15"	42"	27	\$308	+\$32



# 9900 Series Laterals

## Build-Ups

Cabinet Interiors

Drawer and Shelf Interiors

### How to order

1. Specify basic cabinet product number followed by drawer and shelf interiors with their accessories (see Accessories section) in order from TOP to BOTTOM, indicating which interior is in the top position. Interiors may be specified in almost any combination to make up the TOTAL INTERIOR HEIGHT.
2. Specify finish color

### Product code key example

**15LUE/PL-36**

**15** module height  
**LU** lift-up  
**E** 9900 Series  
**PL** plastic laminate pull out shelf  
**36** width

### General information

Drawers and shelf interiors on these pages do not include accessories. For drawers with accessories see complete media modules preceding this section. See Lateral File Accessories section for accessories.

### Finishes

Refer to Finishes section for color options. Drawer bodies and accessories are finished in Eco Black.

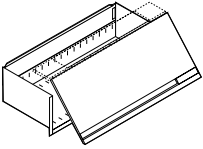
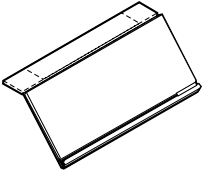
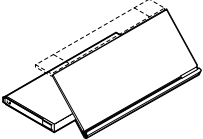
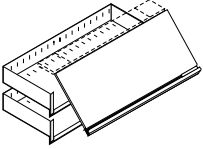
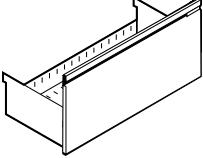
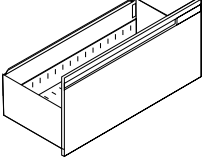
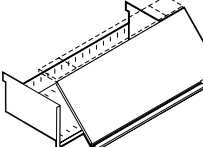
Description	Part number	Exterior height	Width	Weight (lbs)	9900 series/ Neutral paint	Accent paint
 15" lift-up door with fixed shelf with raised back	<b>15LUE/FS-30RB</b>	15"	30"	20	\$248	+\$26
	<b>15LUE/FS-36RB</b>	15"	36"	23	\$287	+\$30
	<b>15LUE/FS-42RB</b>	15"	42"	27	\$330	+\$34
 15" lift-up door	<b>15LUE-30</b>	15"	30"	12	\$145	+\$16
	<b>15LUE-36</b>	15"	36"	15	\$177	+\$19
	<b>15LUE-42</b>	15"	42"	19	\$197	+\$21
 15" lift-up door with plastic laminate pullout shelf	<b>15LUE/PL-30</b>	15"	30"	36	\$498	+\$51
	<b>15LUE/PL-36</b>	15"	36"	45	\$547	+\$56
	<b>15LUE/PL-42</b>	15"	42"	54	\$599	+\$61
 15" lift-up door with 2 pullout shelves, 9" and 6"	<b>15LUE/96PS-30</b>	15"	30"	23	\$418	+\$43
	<b>15LUE/96PS-36</b>	15"	36"	28	\$453	+\$47
	<b>15LUE/96PS-42</b>	15"	42"	33	\$498	+\$51
 16.5" Opening Interiors 16.5" fixed front drawer	<b>16.5FFE-30</b>	16.5"	30"	17	\$309	+\$32
	<b>16.5FFE-36</b>	16.5"	36"	20	\$338	+\$36
	<b>16.5FFE-42</b>	16.5"	42"	24	\$392	+\$41
 16.5" fixed front drawer with raised back	<b>16.5FFE-30RB</b>	16.5"	30"	17	\$329	+\$34
	<b>16.5FFE-36RB</b>	16.5"	36"	20	\$360	+\$38
	<b>16.5FFE-42RB</b>	16.5"	42"	24	\$415	+\$43
 16.5" lift-up door with pullout shelf	<b>16.5LUE/PS-30</b>	16.5"	30"	22	\$309	+\$32
	<b>16.5LUE/PS-36</b>	16.5"	36"	26	\$338	+\$36
	<b>16.5LUE/PS-42</b>	16.5"	42"	30	\$392	+\$41

# 9900 Series Laterals

**Build-Ups**  
Cabinet Interiors  
Drawer and Shelf Interiors

## How to order

- Specify basic cabinet product number followed by drawer and shelf interiors with their accessories (see Accessories section) in order from TOP to BOTTOM, indicating which interior is in the top position. Interiors may be specified in almost any combination to make up the TOTAL INTERIOR HEIGHT.
- Specify finish color

## Product code key example

**16.5LUE/PL-36**

**16.5** module height  
**LU** lift-up  
**E** 9900 Series  
**PL** plastic laminate pull out shelf  
**36** width

## General information

Drawers and shelf interiors on these pages do not include accessories. For drawers with accessories see complete media modules preceding this section. See Lateral File Accessories section for accessories.

## Finishes

Refer to Finishes section for color options. Drawer bodies and accessories are finished in Eco Black.

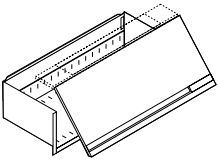
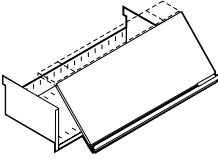
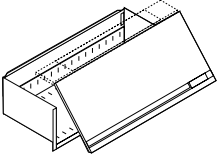
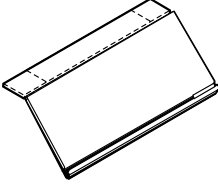
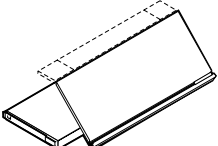
Description	Part number	Exterior height	Width	Weight (lbs)	9900 series/ Neutral paint	Accent paint
 16.5" lift-up door with pullout shelf with raised back	<b>16.5LUE/PS-30RB</b>	16.5"	30"	22	\$329	+\$34
	<b>16.5LUE/PS-36RB</b>	16.5"	36"	26	\$360	+\$38
	<b>16.5LUE/PS-42RB</b>	16.5"	42"	30	\$415	+\$43
 16.5" lift-up door with fixed shelf	<b>16.5LUE/FS-30</b>	16.5"	30"	21	\$279	+\$29
	<b>16.5LUE/FS-36</b>	16.5"	36"	24	\$303	+\$31
	<b>16.5LUE/FS-42</b>	16.5"	42"	28	\$351	+\$37
 16.5" lift-up door with fixed shelf with raised back	<b>16.5LUE/FS-30RB</b>	16.5"	30"	21	\$299	+\$31
	<b>16.5LUE/FS-36RB</b>	16.5"	36"	24	\$323	+\$33
	<b>16.5LUE/FS-42RB</b>	16.5"	42"	28	\$373	+\$39
 16.5" lift-up door	<b>16.5LUE-30</b>	16.5"	30"	13	\$204	+\$22
	<b>16.5LUE-36</b>	16.5"	36"	16	\$230	+\$24
	<b>16.5LUE-42</b>	16.5"	42"	20	\$281	+\$29
 16.5" lift-up door with plastic laminate pullout shelf	<b>16.5LUE/PL-30</b>	16.5"	30"	37	\$561	+\$57
	<b>16.5LUE/PL-36</b>	16.5"	36"	46	\$627	+\$63
	<b>16.5LUE/PL-42</b>	16.5"	42"	55	\$705	+\$73

# 9900 Series Laterals

## Build-Ups

### Cabinet Interiors

#### Hinged Door Cabinet Inserts

#### How to order

1. Specify basic cabinet product number followed by drawer and shelf interiors with their accessories (see Accessories section) in order from TOP to BOTTOM, indicating which interior is in the top position. Interiors may be specified in almost any combination to make up the TOTAL INTERIOR HEIGHT.
2. Specify finish color

#### Product code key example

#### 24HDE/SH-36

**24** module height  
**HD** hinged door  
**E** 9900 Series  
**SH** shelf  
**36** width

A hinged door insert includes a bottom shelf. This means that the insert door height and usable interior space is actually 1 1/2" less than the heights noted in the descriptions.

#### Lock option

Hinged door inserts come standard with lock. If lock is not required add suffix '/NL' after product number. Deduct \$50 list.

#### General information

Drawers and shelf interiors on these pages do not include accessories. For drawers with accessories see complete media modules preceding this section. See Lateral File Accessories section for accessories.

#### Finishes

Refer to Finishes section for color options. Drawer bodies and accessories are finished in Eco Black.

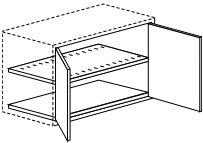
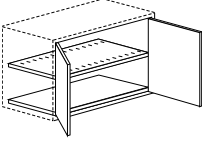
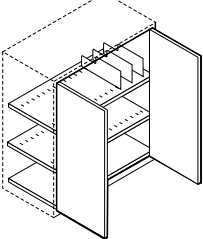
Description	Part number	Exterior height	Width	Weight (lbs)	9900 series/ Neutral paint	Accent paint
 <p>24" hinged door cupboard insert with 1 adjustable slotted shelf. Shelf dividers are not included. Bottom shelf is standard with slots. Must be specified in the top opening.</p>	<b>24HDE/SH-30</b>	24"	30"	36	\$529	+\$54
	<b>24HDE/SH-36</b>	24"	36"	50	\$565	+\$57
	<b>24HDE/SH-42</b>	24"	42"	64	\$650	+\$66
 <p>27" hinged door cupboard insert with 1 adjustable slotted shelf. Shelf dividers are not included. Bottom shelf is standard with slots. Must be specified in the top opening.</p>	<b>27HDE/SH-30</b>	27"	30"	38	\$529	+\$54
	<b>27HDE/SH-36</b>	27"	36"	52	\$565	+\$57
	<b>27HDE/SH-42</b>	27"	42"	62	\$650	+\$66
 <p>39" hinged door cupboard insert with 2 adjustable slotted shelf. Shelf dividers are not included. Will accommodate 3 rows of standard binders. Bottom shelf is standard with slots. Must be specified in the top opening.</p>	<b>39HDE/SH-30</b>	39"	30"	52	\$588	+\$60
	<b>39HDE/SH-36</b>	39"	36"	78	\$624	+\$63
	<b>39HDE/SH-42</b>	39"	42"	93	\$705	+\$73

## How to order

- Specify basic cabinet product number followed by drawer and shelf interiors with their accessories (see Accessories section) in order from TOP to BOTTOM, indicating which interior is in the top position. Interiors may be specified in almost any combination to make up the TOTAL INTERIOR HEIGHT.
- Specify finish color

## Product code key example

**24SS-36**

**24** module height  
**SS** SuperStor™ insert  
**36** width

A hinged door insert includes a bottom shelf. This means that the insert door height and usable interior space is actually 1 ½" less than the heights noted in the descriptions.

## Lock option

SuperStor™ inserts with hinged doors come standard with lock. If lock is not required add suffix '/NL' after product number. Deduct \$50 list.

**Note: Locks cannot be field installed on hinged door cabinets.**

## General information

**SuperStor™ inserts are designed exclusively to fit inside 36" wide cabinets.** SuperStor™ inserts are built with a horizontal support at the base of the unit which functions as a tie bar. Depending on the components specified for the cabinet interior an additional tie bar need not be specified if the specified components fill the cabinet interior. SuperStor™ tray fronts angle downwards ½" to permit labeling. **SuperStor™ trays are sold separately.**

## Finishes

Refer to Finishes section for color options. Drawer bodies and accessories are finished in Eco Black.

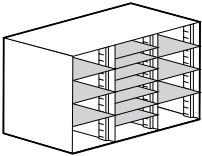
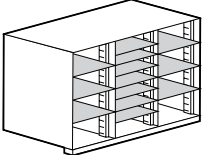
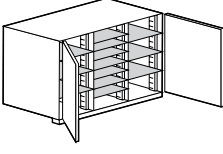
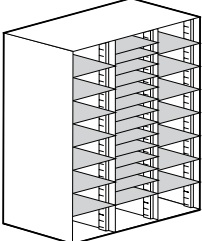
Description	Part number	Exterior height	Width	Weight (lbs)	9900 series/ Neutral paint	Accent paint
 <p>This SuperStor™ insert is designed exclusively to fit inside a cabinet with an interior height of 24". Insert contains 3 vertical compartments each with 22 slots at 1" increments. Order trays separately.</p>	<b>24SS-36</b>	24"	36"	55	\$486	+\$50
 <p>25.5" Opening Interior 25.5" SuperStor™ insert with or without hinged doors, contains 3 vertical compartments each with 22 slots at 1" increments. May be installed in cabinets with 36" or more interior. SuperStor™ insert must be specified in the top opening of your build-up. Order trays separately.</p>	<b>25.5SS-36</b>	25.5"	36"	55	\$486	+\$50
 <p>25.5" Opening Interior 25.5" SuperStor™ insert with or without hinged doors, contains 3 vertical compartments each with 22 slots at 1" increments. May be installed in cabinets with 36" or more interior. SuperStor™ insert must be specified in the top opening of your build-up. Order trays separately.</p>	<b>25.5SSHD□-36</b>	25.5"	36"	80	\$821	+\$84
 <p>This SuperStor™ insert is designed exclusively to fit inside a cabinet with an interior height of 49.5". Insert contains 3 vertical compartments each with 48 slots at 1" increments. Order trays separately.</p>	<b>49.5SS-36</b>	49.5"	36"	110	\$795	+\$81

# 9900 Series Laterals

## Build-Ups Cabinet Interiors SuperStor™ Inserts

### How to order

1. Specify basic cabinet product number followed by drawer and shelf interiors with their accessories (see Accessories section) in order from TOP to BOTTOM, indicating which interior is in the top position. Interiors may be specified in almost any combination to make up the TOTAL INTERIOR HEIGHT.
2. Specify finish color

### Product code key example **51SS-36**

- 51** module height  
**SS** SuperStor™ insert  
**36** width

### General information

**SuperStor™ inserts are designed exclusively to fit inside 36" wide cabinets.** SuperStor™ inserts are built with a horizontal support at the base of the unit which functions as a tie bar. Depending on the components specified for the cabinet interior an additional tie bar need not be specified if the specified components fill the cabinet interior. SuperStor™ tray fronts angle downwards ½" to permit labeling. **SuperStor™ trays are sold separately.**

A hinged door insert includes a bottom shelf. This means that the insert door height and usable interior space is actually 1 ½" less than the heights noted in the descriptions.

### Lock option

SuperStor™ inserts with hinged doors come standard with lock. If lock is not required add suffix '/NL' after product number. Deduct \$50 list.

**Note: Locks cannot be field installed on hinged door cabinets.**

### Finishes

Refer to Finishes section for color options. Drawer bodies and accessories are finished in Eco Black. SuperStore and trays are Onyx only.

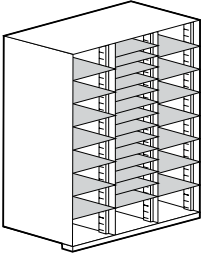
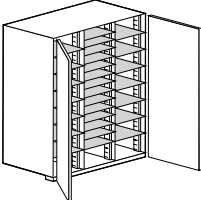
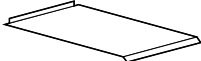
Description	Part number	Exterior height	Width	Weight (lbs)	9900 series/ Neutral paint	Accent paint
 <p>51" Opening Interior 51" SuperStor™ insert with or without hinged doors, contains 3 vertical compartments each with 48" slots at 1" increments. May be installed in cabinets with 58.5" or more interior. SuperStor™ inserts must be specified in the top opening of your build-up. Order trays separately.</p>	<b>51SS-36</b>	51"	36"	110	\$769	+\$79
 <p>51" Opening Interior 51" SuperStor™ insert with or without hinged doors, contains 3 vertical compartments each with 48" slots at 1" increments. May be installed in cabinets with 58.5" or more interior. SuperStor™ inserts must be specified in the top opening of your build-up. Order trays separately.</p>	<b>51SSHD□-36</b>	51"	36"	195	\$1341	+\$135
 <p>SuperStor™ trays Pack of 12 trays, black only</p>	<b>T12SS-BL</b>	—	10"	25	\$240	—

---

# Towers



# Towers

## Modular towers

### ANSI/BIFMA

With the addition of counterweights where appropriate, Modular Towers meet all ANSI/BIFMA specifications.

### Construction

Modular Towers and hinged door cabinets are constructed using 20 and 22 gauge high quality, tension leveled, cold rolled steel. The steel gauges selected for drawer fronts, bodies and accessories ensure the highest quality durability and performance for all components.

### Construction features & benefits

1. All interiors are modular and interchangeable so that cabinets can be retrofitted with new accessories and interiors as required.
2. Case corners are strengthened with a reinforcing zinc die cast corner bracket.
3. Absence of scissor mechanism in doors and drawers eliminates the potential for scissors binding and facilitates reconfiguration of cabinet openings as needed.
4. Box drawer sides are slotted on 1" centers to allow for maximum flexibility for drawer division.
5. Box drawer side double-wall construction provides clean appearance and enclosed divider slots.
6. File drawer bodies have full-height sides to accommodate hanging file folders, eliminating the need for optional file frames.
7. Front leading edge of shelf is flat for easy removal of material.
8. Fully-progressive ball bearing suspensions are staged so that left and right sides work in unison. This provides smooth drawer operation with minimum force.
9. Special "claw-like" device incorporated in suspensions "grips" the fixed section of the suspension arm preventing drawer bounce-back or creep when drawer is closed.
10. Self-closing, 110° opening, European style cupboard hinges provide smooth hinged door operation. Hinges are not visible from the exterior of the cabinet.

### Drawer pulls

9900 Series fronts have full width integral pulls with enamel finish to match case fronts.

### Safelock™

The patented Safelock™ mechanism provides complete security against accidental opening of two or more drawers simultaneously. When any drawer or single pullout shelf is extended, even fractionally, Safelock™ ensures that all other openings immediately become inoperable. Safelock™ is standard on all towers.

### Counterweights

See Counterweight matrix on page 023.

### Glides

Overall heights are inclusive of metal glides. Heights may be increased up to 3/8" by extending standard glide. Glides are accessible from inside the cabinet when the bottom drawer is fully extended or removed and may be adjusted with a 1/4" socket driver.

Optional 1 1/2" stem glides are available. Specify separately and add \$26 list to the cabinet price. Requires field installation.

### Locks

Modular Towers come standard with lock. If lock is not required add suffix '**NL**' after product number. Deduct \$50 list per lock. For lock location, see guide at the beginning of this price list.

Random keying is standard. Files may be ordered keyed alike. Specify. Locks feature removable core and are standard with two keys, one of which has a black neoprene plastic key cover.

Master keys are available at \$45 list. For lock finish options, refer to the front of this price list.

### Finishes

Refer to Finishes section for color options.

**Note: Modular Towers are chamfered at each corner and are approximately 3/8" higher than workplace towers.**

## How to order

1. Specify product number.
2. Specify finish color.
3. Specify options.

## Product code key example

### MR2424E-P2F10

**M** Modular Series  
**R** right-handed door  
**24** tower width  
**24** interior height  
**E** 9900 Series  
**P** pencil drawer  
**2** number of drawers  
**F10** 10 ½" file drawer

## General information

Exterior cabinet heights are actual heights with glides fully recessed. Units containing pencil and/or box drawers include one pencil tray per unit. Each box drawer contains one steel divider. 10½" and 12" drawers have one sliding rail for side-to-side filing of letter size folders or printout binders. Hinged doors are standard with self closing European style hinges and open 110°.

## Lock option

Modular towers come standard with lock. If lock is not required add suffix 'N/L' after product number. Deduct \$50 list per lock.

## Counterweights

See Counterweight matrix on page 023.

## Accessories

Refer to Accessories section for options.

## Finishes

Refer to Finishes section for color options. Interior drawer bodies and shelves are finished in Eco Black. Bookshelves in side access towers are the same finish as the case.

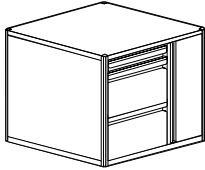
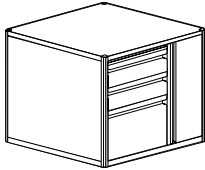
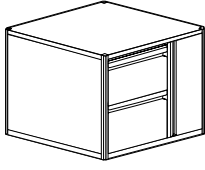
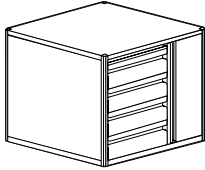
Description	Part number	Exterior height	Width	Depth	Weight (lbs)	Neutral paint/ base price	Accent paint
 <p>Full-length hinged door on one side, 1-3" pencil and 2-10.5" file drawers on the other side. Comes with 2 locks and counterweights.</p>	<b>ML2424E-P2F10</b>	27 ¼"	24"	24"	102	\$1609	+\$162
	<b>ML3024E-P2F10</b>	27 ¼"	30"	24"	118	\$1705	+\$171
	<b>MR2424E-P2F10</b>	27 ¼"	24"	24"	102	\$1609	+\$162
	<b>MR3024E-P2F10</b>	27 ¼"	30"	24"	118	\$1705	+\$171
 <p>Full-length hinged door on one side 2-6" box and 1-12" file drawer on the other side. Comes with 2 locks and counterweights.</p>	<b>ML2424E-2BF</b>	27 ¼"	24"	24"	102	\$1609	+\$162
	<b>ML3024E-2BF</b>	27 ¼"	30"	24"	118	\$1705	+\$171
	<b>MR2424E-2BF</b>	27 ¼"	24"	24"	102	\$1609	+\$162
	<b>MR3024E-2BF</b>	27 ¼"	30"	24"	118	\$1705	+\$171
 <p>Full-length hinged door on one side, 2-12" file drawers on the other side. Comes with 2 locks and counterweights.</p>	<b>ML2424E-2F</b>	27 ¼"	24"	24"	102	\$1553	+\$157
	<b>ML3024E-2F</b>	27 ¼"	30"	24"	118	\$1647	+\$166
	<b>MR2424E-2F</b>	27 ¼"	24"	24"	102	\$1553	+\$157
	<b>MR3024E-2F</b>	27 ¼"	30"	24"	118	\$1647	+\$166
 <p>Full-length hinged door on one side, 4-6" box drawers on the other side. Comes with 2 locks and counterweights.</p>	<b>ML2424E-4B</b>	27 ¼"	24"	24"	102	\$1919	+\$193
	<b>ML3024E-4B</b>	27 ¼"	30"	24"	118	\$1988	+\$200
	<b>MR2424E-4B</b>	27 ¼"	24"	24"	102	\$1919	+\$193
	<b>MR3024E-4B</b>	27 ¼"	30"	24"	118	\$1988	+\$200



# Towers

## Modular Towers Base Modules

### How to order

1. Specify product number.
2. Specify finish color.
3. Specify options.

### Product code key example

#### MR3024E-P2F10

- M** Modular Series  
**R** right-handed door  
**24** tower width  
**24** interior height  
**E** 9900 Series  
**D** double pedestal  
**P** pencil drawer  
**2** number of drawers  
**F10** 10 ½" file drawer

Exterior cabinet heights are actual heights with glides fully recessed. Units containing pencil and/or box drawers include one pencil tray per unit. Each box drawer contains one steel divider. 10½" and 12" drawers have one sliding rail for side-to-side filing of letter size folders or printout binders. Hinged doors are standard with self closing European style hinges and open 110°. Specify.

### Lock option

Modular towers come standard with lock. If lock is not required add suffix '/NL' after product number. Deduct \$50 list per lock.

### Counterweights

Counterweights are required for ALL freestanding units that are not anchored or ganged to other cabinets or bolted to walls/floor. See Counterweight matrix on page 023.

### Accessories

Refer to Accessories section for options.

### Finishes

Refer to Finishes section for color options. Interior drawer bodies and shelves are finished in Eco Black. Bookshelves in side access towers are the same finish as the case.

### General information

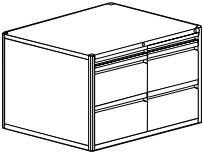
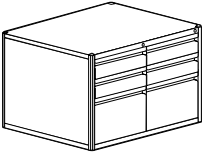
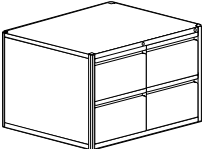
Description	Part number	Exterior height	Width	Depth	Weight (lbs)	Neutral paint/ base price	Accent paint
 <p>1-3" pencil and 2-10.5" file drawers on both sides. Comes with 2 locks and counterweights.</p>	<b>M3024E-DP2F10</b>	27 ¼"	30"	24"	180	\$2651	+\$266
 <p>2-6" box and 1-12" file drawer on both sides. Comes with 2 locks and counterweights.</p>	<b>M3024E-D2BF</b>	27 ¼"	30"	24"	180	\$2651	+\$266
 <p>2-12" file drawers on both sides. Comes with 2 locks and counterweights.</p>	<b>M3024E-D2F</b>	27 ¼"	30"	24"	180	\$2569	+\$258

### How to order

1. Specify product number.
2. Specify finish color.
3. Specify options.

### Product code key example

#### MRM2424E-P2F10

- M** Modular Series
- R** right-handed door
- M** MoPed
- 24** tower width
- 24** interior height
- E** 9900 Series
- P** pencil drawer
- 2** number of drawers
- F10** 10 1/2" file drawer

### General information

Exterior cabinet heights are actual heights with glides fully recessed. Units containing pencil and/or box drawers include one pencil tray per unit. Each box drawer contains one steel divider. 10 1/2" and 12" drawers have one sliding rail for side-to-side filing of letter size folders or printout binders. Hinged doors are standard with self closing European style hinges and open 110°.

### Lock option

Modular towers come standard with lock. If lock is not required add suffix 'NL' after product number. Deduct \$50 list per lock.

### Counterweights

See Counterweight matrix on page 023.

### Accessories

Refer to Accessories section for options.

### Finishes

Refer to Finishes section for color options. Interior drawer bodies and shelves are finished in Eco Black. Interior of MoPed is aluminum painted.

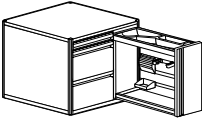
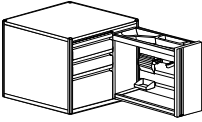
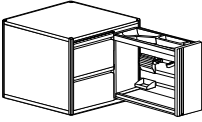
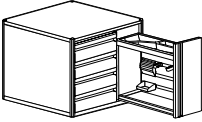
Description	Part number	Exterior height	Width	Depth	Weight (lbs)	Neutral paint/ base price	Accent paint
 <p>MoPed on one side, 1-3" pencil and 2-10.5" file drawers on the other side. Comes with 2 locks and counterweights. Accessories are not included in MoPed.</p>	<b>MLM2424EP2F10</b> left-handed 5" sliding drawer	27 1/4"	24"	24"	116	\$2048	+\$205
	<b>MRM2424EP2F10</b> right-handed 5" sliding drawer (illustrated)	27 1/4"	24"	24"	116	\$2048	+\$205
 <p>MoPed on one side, 2-6" box and 1-12" file drawer on the other side. Comes with 2 locks and counterweights. Accessories are not included in MoPed.</p>	<b>MLM2424E-2BF</b> left-handed 5" sliding drawer	27 1/4"	24"	24"	116	\$2048	+\$205
	<b>MRM2424E-2BF</b> right-handed 5" sliding drawer (illustrated)	27 1/4"	24"	24"	116	\$2048	+\$205
 <p>MoPed on one side, 2-12" file drawers on the other side. Comes with 2 locks and counterweights. Accessories are not included in MoPed.</p>	<b>MLM2424E-2F</b> left-handed 5" sliding drawer	27 1/4"	24"	24"	116	\$1869	+\$188
	<b>MRM2424E-2F</b> right-handed 5" sliding drawer (illustrated)	27 1/4"	24"	24"	116	\$1869	+\$188
 <p>MoPed on one side, 4-6" box drawers on the other side. Comes with 2 locks and counterweights. Accessories are not included in MoPed.</p>	<b>MLM2424E-4B</b> left-handed 5" sliding drawer	27 1/4"	24"	24"	116	\$2238	+\$225
	<b>MRM2424E-4B</b> right-handed 5" sliding drawer (illustrated)	27 1/4"	24"	24"	116	\$2238	+\$225

# Towers

## Modular Towers Stack Modules

### How to order

1. Specify product number.
2. Specify finish color.
3. Specify options.

### Product code key example

#### M2419.5E-HD

**M** Modular Series  
**24** tower width  
**19.5** interior height  
**E** 9900 Series  
**HD** hinged door

### General information

Exterior cabinet heights are actual heights with glides fully recessed. Units containing pencil and/or box drawers include one pencil tray per unit. Each box drawer contains one steel divider. 10½" and 12" drawers have one sliding rail for side-to-side filing of letter size folders or printout binders. Hinged doors are standard with self closing European style hinges and open 110°.

### Counterweights

See Counterweight matrix on page 023.

### Lock option

Modular towers come standard with lock. If lock is not required add suffix '/NL' after product number. Deduct \$50 list per lock.

### Accessories

Refer to Accessories section for options.

### Finishes

Refer to Finishes section for color options. Interior drawer bodies and shelves are finished in Eco Black. Bookshelves in side access towers are the same finish as the case.

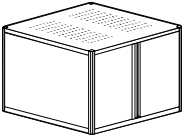
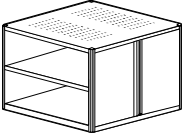
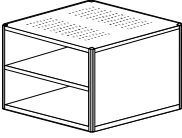
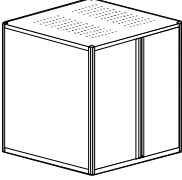
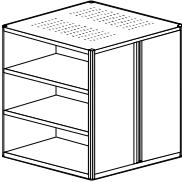
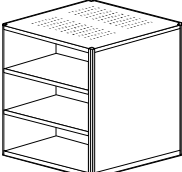
Description	Part number	Exterior height	Width	Depth	Weight (lbs)	Neutral paint/ base price	Accent paint
 <p>Two full-length hinged doors with 1 shelf per side. Comes with 2 locks</p>	<b>M2419.5E-HD</b>	22 ¾"	24"	24"	75	\$1036	+\$105
	<b>M3019.5E-HD</b>	22 ¾"	30"	24"	91	\$1155	+\$117
 <p>Full-length hinged door on one side (30" wide comes with 1 shelf), 19.5" side access bookcase with 1 shelf on the other side. Comes with 1 lock.</p>	<b>ML2419.5E-HDK</b>	22 ¾"	24"	24"	75	\$923	+\$94
	<b>ML3019.5E-HDK</b> left-handed hinged door	22 ¾"	30"	24"	91	\$1131	+\$115
	<b>MR2419.5E-HDK</b>	22 ¾"	24"	24"	75	\$923	+\$94
	<b>MR3019.5E-HDK</b> right-handed hinged door (illustrated)	22 ¾"	30"	24"	91	\$1131	+\$115
 <p>Two 19.5" side access bookcases with 1 shelf per side.</p>	<b>M2419.5-2K</b>	22 ¾"	24"	24"	75	\$1018	+\$103
	<b>M3019.5-2K</b>	22 ¾"	30"	24"	91	\$1074	+\$109
 <p>Two full-length hinged doors with 2 shelves per side. Comes with 2 locks.</p>	<b>M2433E-HD</b>	36 ¼"	24"	24"	92	\$1337	+\$134
	<b>M3033E-HD</b>	36 ¼"	30"	24"	114	\$1436	+\$146
 <p>Full-length hinged door with coat rod on one side, 33" side access bookcase with 2 shelves on the other side. Comes with 1 lock.</p>	<b>ML2433E-HDK</b>	36 ¼"	24"	24"	92	\$1194	+\$121
	<b>ML3033E-HDK</b> left-handed hinged door	36 ¼"	30"	24"	114	\$1396	+\$142
	<b>MR2433E-HDK</b>	36 ¼"	24"	24"	92	\$1194	+\$121
	<b>MR3033E-HDK</b> right-handed hinged door (illustrated)	36 ¼"	30"	24"	114	\$1396	+\$142
 <p>Two 33" high side access bookcases with 2 shelves per side.</p>	<b>M2433-2K</b>	36 ¼"	24"	24"	92	\$1244	+\$125
	<b>M3033-2K</b>	36 ¼"	30"	24"	114	\$1349	+\$135

### How to order

1. Specify product number.
2. Specify finish color.
3. Specify options.

### Product code key example

**MR1658E-BB7FK**

- M** Modular Series
- R** right-handed door
- 16** tower width
- 58** interior height
- E** 9900 Series
- B** 6" box drawer
- B7** 7 1/2" box drawer
- F** 12" file drawer
- K** bookcase

### General information

Exterior cabinet heights are actual heights with glides fully recessed. Units containing pencil and/or box drawers include one pencil tray per unit. Each box drawer contains one steel divider. 10 1/2" and 12" drawers have one sliding rail for side-to-side filing of letter size folders or printout binders. Hinged doors are standard with self closing European style hinges and open 110°.

### Counterweights

See Counterweight matrix on page 023.

### Lock option

Modular towers come standard with lock. If lock is not required add suffix '**/NL**' after product number. Deduct \$50 list per lock.

### Accessories

Refer to Accessories section for options.

### Finishes

Refer to Finishes section for color options. Interior drawer bodies and shelves are finished in Eco Black. Bookshelves in side access towers are the same finish as the case.

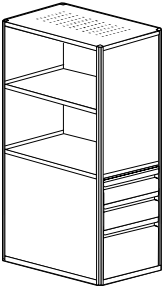
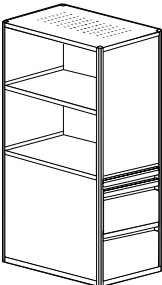
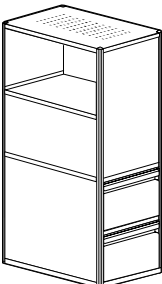
Description	Part number	Exterior height	Width	Depth	Weight (lbs)	Neutral paint/ base price	Accent paint
 <p>31.5" bookcase with pedestal consisting of 1-6" box drawer, 1-7.5" box drawer and 1-12" file drawer. Comes with 1 lock.</p>	<b>ML1658E-BB7FK</b> left hand	61 3/4"	16"	24"	130	\$2600	+\$261
	<b>MR1658E-BB7FK</b> right hand (illustrated)	61 3/4"	16"	24"	130	\$2600	+\$261
 <p>31.5" bookcase with pedestal consisting of 1-3" pencil drawer 1-10.5" file drawer and 1-12" file drawer. Comes with 1 lock.</p>	<b>ML1658E-PF10FK</b> left hand	61 3/4"	16"	24"	130	\$2600	+\$261
	<b>MR1658E-PF10FK</b> right hand (illustrated)	61 3/4"	16"	24"	130	\$2600	+\$261
 <p>15" bookcase on each side with pedestal consisting of 2-12" individually locking file drawers. Comes with 2 locks.</p>	<b>M1658E-2FTBKS</b>	61 3/4"	16"	24"	130	\$2845	+\$287

# Towers

## Modular Towers Monolithic Units

### How to order

1. Specify product number.
2. Specify finish color.
3. Specify options.

### Product code key example

#### MR2443E-P2F

<b>M</b>	Modular Series
<b>R</b>	right-handed door
<b>24</b>	tower width
<b>43</b>	interior height
<b>E</b>	9900 Series
<b>P</b>	pencil drawer
<b>2</b>	number of drawers
<b>F</b>	12" file drawer

### General information

Exterior cabinet heights are actual heights with glides fully recessed. Units containing pencil and/or box drawers include one pencil tray per unit. Each box drawer contains one steel divider. 10½" and 12" drawers have one sliding rail for side-to-side filing of letter size folders or printout binders. Hinged doors are standard with self closing European style hinges and open 110°.

A hinged door insert includes a bottom shelf. This means that the insert door height and usable interior space is actually 1 ½" less than the heights noted in the descriptions.

### Counterweights

See Counterweight matrix on page 023.

### Lock option

Modular towers come standard with lock. If lock is not required add suffix 'NL' after product number. Deduct \$50 list per lock.

### Accessories

Refer to Accessories section for options.

### Finishes

Refer to Finishes section for color options. Interior drawer bodies and shelves are finished in Eco Black. Bookshelves in side access towers are the same finish as the case.

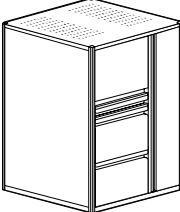
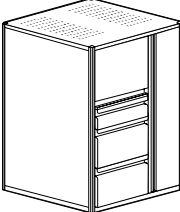
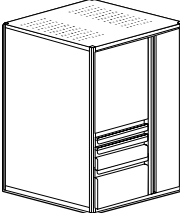
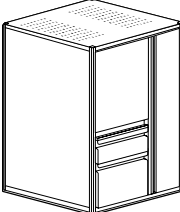
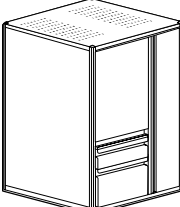
Description	Part number	Exterior height	Width	Depth	Weight (lbs)	Neutral paint/ base price	Accent paint
 <p>Full-length door with coat rod on one side, 16.5" high hinged door insert, 1-3" pencil and 2-12" file drawers on the other side. Comes with 3 locks.</p>	<b>ML2443E-P2F</b>	46 ¾"	24"	24"	145	\$2918	+\$294
	<b>ML3043E-P2F</b>	46 ¾"	30"	24"	162	\$3066	+\$308
	<b>MR2443E-P2F</b>	46 ¾"	24"	24"	145	\$2918	+\$294
	<b>MR3043E-P2F</b>	46 ¾"	30"	24"	162	\$3066	+\$308
 <p>Full-length door with coat rod on one side, 16.5" high hinged door insert, 1-6" box and 2-10.5" file drawers on the other side. Comes with 3 locks.</p>	<b>ML2443E-B2F10</b>	46 ¾"	24"	24"	145	\$2918	+\$294
	<b>ML3043E-B2F10</b>	46 ¾"	30"	24"	162	\$3066	+\$308
	<b>MR2443E-B2F10</b>	46 ¾"	24"	24"	145	\$2918	+\$294
	<b>MR3043E-B2F10</b>	46 ¾"	30"	24"	162	\$3066	+\$308
 <p>Full-length door with coat rod on one side, 24" high hinged door insert with 1 shelf, 1-3" pencil, 1-6" box and 1-10.5" file drawer on the other side. Comes with 3 locks.</p>	<b>ML2443E-PBF10</b>	46 ¾"	24"	24"	145	\$2918	+\$294
	<b>ML3043E-PBF10</b>	46 ¾"	30"	24"	162	\$3066	+\$308
	<b>MR2443E-PBF10</b>	46 ¾"	24"	24"	145	\$2918	+\$294
	<b>MR3043E-PBF10</b>	46 ¾"	30"	24"	162	\$3066	+\$308
 <p>Full-length door with coat rod on one side, 24" high hinged door insert with 1 shelf, 1-7.5" box and 1-12" - file drawer on the other side. Comes with 3 locks.</p>	<b>ML2443E-B7F</b>	46 ¾"	24"	24"	145	\$2791	+\$281
	<b>ML3043E-B7F</b>	46 ¾"	30"	24"	162	\$2940	+\$296
	<b>MR2443E-B7F</b>	46 ¾"	24"	24"	145	\$2791	+\$281
	<b>MR3043E-B7F</b>	46 ¾"	30"	24"	162	\$2940	+\$296
 <p>Full-length door with coat rod on one side, 27" high hinged door insert with 1 shelf, 1-6" box and 1-10.5" file drawer on the other side. Comes with 3 locks.</p>	<b>ML2443E-BF10</b>	46 ¾"	24"	24"	145	\$2791	+\$281
	<b>ML3043E-BF10</b>	46 ¾"	30"	24"	162	\$2940	+\$296
	<b>MR2443E-BF10</b>	46 ¾"	24"	24"	145	\$2791	+\$281
	<b>MR3043E-BF10</b>	46 ¾"	30"	24"	162	\$2940	+\$296

### How to order

1. Specify product number.
2. Specify finish color.
3. Specify options.

### Product code key example

**MR2443E-PF10FK**

- M** Modular Series
- R** right-handed door
- 24** tower width
- 43** interior height
- E** 9900 Series
- P** pencil drawer
- F10** 10 ½" file drawer
- F** 12" file drawer
- K** bookcase

Exterior cabinet heights are actual heights with glides fully recessed. Units containing pencil and/or box drawers include one pencil tray per unit. Each box drawer contains one steel divider. 10½" and 12" drawers have one sliding rail for side-to-side filing of letter size folders or printout binders. Hinged doors are standard with self closing European style hinges and open 110°.

### Counterweights

See Counterweight matrix on page 023.

### Lock option

Modular towers come standard with lock. If lock is not required add suffix '**/NL**' after product number. Deduct \$50 list per lock.

### Accessories

Refer to Accessories section for options.

### Finishes

Refer to Finishes section for color options. Interior drawer bodies and shelves are finished in Eco Black. Bookshelves in side access towers are the same finish as the case.

### General information

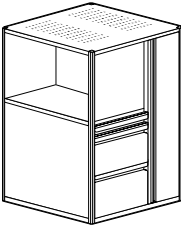
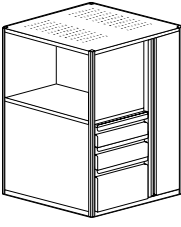
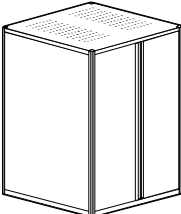
Description	Part number	Exterior height	Width	Depth	Weight (lbs)	Neutral paint/ base price	Accent paint
 <p>Full-length door with coat rod on one side, 1-16.5" high side access bookcase, 1-3" pencil, 1-10.5" and 1-12" file drawer on the other side. Comes with 2 locks.</p>	<b>ML2443EPF10FK</b>	46 ¾"	24"	24"	150	\$2614	+\$262
	<b>ML3043EPF10FK</b>	46 ¾"	30"	24"	167	\$2746	+\$276
	<b>MR2443EPF10FK</b>	46 ¾"	24"	24"	150	\$2614	+\$262
	<b>MR3043EPF10FK</b>	46 ¾"	30"	24"	167	\$2746	+\$276
 <p>Full-length door with coat rod on one side, 16.5" high side access bookcase, 1-6" box, 1-7.5" box and 1-12" file drawer on the other side. Comes with 2 locks.</p>	<b>ML2443E-BB7FK</b>	46 ¾"	24"	24"	150	\$2613	+\$262
	<b>ML3043E-BB7FK</b>	46 ¾"	30"	24"	167	\$2745	+\$276
	<b>MR2443E-BB7FK</b>	46 ¾"	24"	24"	150	\$2613	+\$262
	<b>MR3043E-BB7FK</b>	46 ¾"	30"	24"	167	\$2745	+\$276
 <p>Two full-length hinged doors, coat rod on one side and shelves on the other side. Comes with 2 locks.</p>	<b>ML2443E-HD</b>	46 ¾"	24"	24"	118	\$2076	+\$209
	<b>ML3043E-HD</b>	46 ¾"	30"	24"	135	\$2217	+\$223
	<b>MR2443E-HD</b>	46 ¾"	24"	24"	118	\$2076	+\$209
	<b>MR3043E-HD</b>	46 ¾"	30"	24"	135	\$2217	+\$223

# Towers

## Modular Towers Monolithic Units

### How to order

1. Specify product number.
2. Specify finish color.
3. Specify options.

### Product code key example

#### MR2445E-2F10

- M** Modular Series  
**R** right-handed door  
**24** tower width  
**45** interior height  
**E** 9900 Series  
**2** number of drawers  
**F10** 10 1/2" file drawer

### General information

Exterior cabinet heights are actual heights with glides fully recessed. Units containing pencil and/or box drawers include one pencil tray per unit. Each box drawer contains one steel divider. 10 1/2" and 12" drawers have one sliding rail for side-to-side filing of letter size folders or printout binders. Hinged doors are standard with self closing European style hinges and open 110°.

A hinged door insert includes a bottom shelf. This means that the insert door height and usable interior space is actually 1 1/2" less than the heights noted in the descriptions.

### Counterweights

See Counterweight matrix on page 023.

### Lock option

Modular towers come standard with lock. If lock is not required add suffix '/NL' after product number. Deduct \$50 list per lock.

### Accessories

Refer to Accessories section for options.

### Finishes

Refer to Finishes section for color options. Interior drawer bodies and shelves are finished in Eco Black. Bookshelves in side access towers are the same finish as the case.

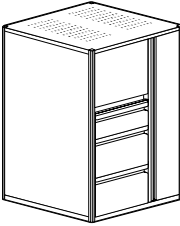
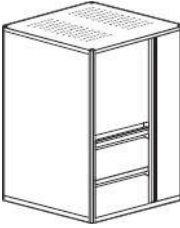
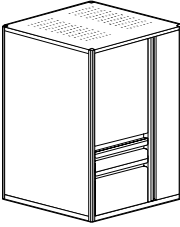
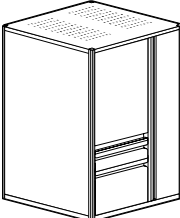
Description	Part number	Exterior height	Width	Depth	Weight (lbs)	Neutral paint/ base price	Accent paint
 <p>Full-length door with coat rod on one side, 16.5" high hinged door insert, 1-7.5 box and 2-10.5" file drawer on the other side. Comes with 3 locks.</p>	<b>ML2445EB72F10</b>	48 1/4"	24"	24"	145	\$2918	+\$294
	<b>ML3045EB72F10</b> left-handed hinged door	48 1/4"	30"	24"	162	\$3066	+\$308
	<b>MR2445EB72F10</b>	48 1/4"	24"	24"	145	\$2918	+\$294
	<b>MR3045EB72F10</b> right-handed hinged door (illustrated)	48 1/4"	30"	24"	162	\$3066	+\$308
 <p>Full-length door with coat rod on one side, 24" hinged door insert with 1 shelf, 2-10.5" file drawers on the other side. Comes with 3 locks.</p>	<b>ML2445E-2F10</b>	48 1/4"	24"	24"	145	\$2791	+\$281
	<b>ML3045E-2F10</b> left-handed hinged door	48 1/4"	30"	24"	162	\$2940	+\$296
	<b>MR2445E-2F10</b>	48 1/4"	24"	24"	145	\$2791	+\$281
	<b>MR3045E-2F10</b> right-handed hinged door (illustrated)	48 1/4"	30"	24"	162	\$2940	+\$296
 <p>Full-length door with coat rod on one side, 27" high hinged door insert with 1 shelf, 1-7.5" box and 1-10.5" file drawer on other side. Comes with 3 locks.</p>	<b>ML2445E-B7F10</b>	48 1/4"	24"	24"	145	\$2791	+\$281
	<b>ML3045E-B7F10</b> left-handed hinged door	48 1/4"	30"	24"	162	\$2940	+\$296
	<b>MR2445E-B7F10</b>	48 1/4"	24"	24"	145	\$2791	+\$281
	<b>MR3045E-B7F10</b> right-handed hinged door (illustrated)	48 1/4"	30"	24"	162	\$2940	+\$296
 <p>Full-length door with coat rod on one side, 27" high hinged door insert with 1 shelf, 1-6" box and 1-12" file drawer on the other side. Comes with 3 locks.</p>	<b>ML2445E-BF</b>	48 1/4"	24"	24"	145	\$2791	+\$281
	<b>ML3045E-BF</b> left-handed hinged door	48 1/4"	30"	24"	162	\$2940	+\$296
	<b>MR2445E-BF</b>	48 1/4"	24"	24"	145	\$2791	+\$281
	<b>MR3045E-BF</b> right-handed hinged door (illustrated)	48 1/4"	30"	24"	162	\$2940	+\$296



### How to order

1. Specify product number.
2. Specify finish color.
3. Specify options.

### Product code key example

**MR2445E-PF10FK**

- M** Modular Series  
**R** right-handed door  
**24** tower width  
**45** interior height  
**E** 9900 Series  
**P** pencil drawer  
**F10** 10 ½" file drawer  
**F** 12" file drawer  
**K** bookcase

### General information

Exterior cabinet heights are actual heights with glides fully recessed. Units containing pencil and/or box drawers include one pencil tray per unit. Each box drawer contains one steel divider. 10½" and 12" drawers have one sliding rail for side-to-side filing of letter size folders or printout binders. Hinged doors are standard with self closing European style hinges and open 110°.

### Counterweights

See Counterweight matrix on page 023.

### Lock option

Modular towers come standard with lock. If lock is not required add suffix '**NL**' after product number. Deduct \$50 list per lock.

### Accessories

Refer to Accessories section for options.

### Finishes

Refer to Finishes section for color options. Interior drawer bodies and shelves are finished in Eco Black. Bookshelves in side access towers are the same finish as the case.

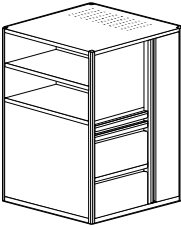
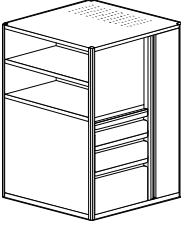
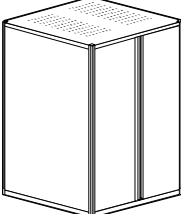
Description	Part number	Exterior height	Width	Depth	Weight (lbs)	Neutral paint/ base price	Accent paint
 <p>Full-length door with coat rod on one side, 18" high side access bookcase with 1 shelf, 1-3" pencil, 1-10.5" and 1-12" file drawers on the other side. Comes with 2 locks.</p>	<b>ML2445EPF10FK</b>	48 ¼"	24"	24"	150	\$2535	+\$255
	<b>ML3045EPF10FK</b>	48 ¼"	30"	24"	167	\$2669	+\$268
	<b>MR2445EPF10FK</b>	48 ¼"	24"	24"	150	\$2535	+\$255
	<b>MR3045EPF10FK</b>	48 ¼"	30"	24"	167	\$2669	+\$268
 <p>Full-length door with coat rod on one side, 18" high side access bookcase with 1 shelf, 1-6" box, 1-7.5" box and 1-12" file drawer on the other side. Comes with 2 locks.</p>	<b>ML2445E-BB7FK</b>	48 ¼"	24"	24"	150	\$2535	+\$255
	<b>ML3045E-BB7FK</b>	48 ¼"	30"	24"	167	\$2669	+\$268
	<b>MR2445E-BB7FK</b>	48 ¼"	24"	24"	150	\$2535	+\$255
	<b>MR3045E-BB7FK</b>	48 ¼"	30"	24"	167	\$2669	+\$268
 <p>Two full-length hinged doors with coat rod on one side and shelves on the other side. Comes with 2 locks.</p>	<b>ML2445E-HD</b>	48 ¼"	24"	24"	118	\$2076	+\$209
	<b>ML3045E-HD</b>	48 ¼"	30"	24"	135	\$2216	+\$223
	<b>MR2445E-HD</b>	48 ¼"	24"	24"	118	\$2076	+\$209
	<b>MR3045E-HD</b>	48 ¼"	30"	24"	135	\$2216	+\$223



# Towers

## Modular Towers Monolithic Units

### How to order

1. Specify product number.
2. Specify finish color.
3. Specify options.

### Product code key example

#### MR2446E-F10F

<b>M</b>	Modular Series
<b>R</b>	right-handed door
<b>24</b>	tower width
<b>46</b>	interior height
<b>E</b>	9900 Series
<b>F10</b>	10 1/2" file drawer
<b>F</b>	12" file drawer

### General information

Exterior cabinet heights are actual heights with glides fully recessed. Units containing pencil and/or box drawers include one pencil tray per unit. Each box drawer contains one steel divider. 10 1/2" and 12" drawers have one sliding rail for side-to-side filing of letter size folders or printout binders. Hinged doors are standard with self closing European style hinges and open 110°.

A hinged door insert includes a bottom shelf. This means that the insert door height and usable interior space is actually 1 1/2" less than the heights noted in the descriptions.

### Counterweights

See Counterweight matrix on page 023.

### Lock option

Modular towers come standard with lock. If lock is not required add suffix 'NL' after product number. Deduct \$50 list per lock.

### Accessories

Refer to Accessories section for options.

### Finishes

Refer to Finishes section for color options. Interior drawer bodies and shelves are finished in Eco Black. Bookshelves in side access towers are the same finish as the case.

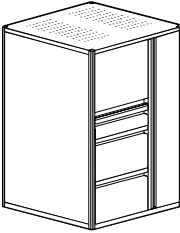
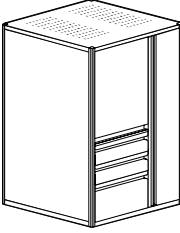
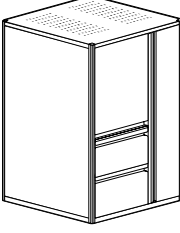
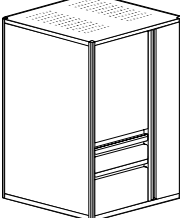
Description	Part number	Exterior height	Width	Depth	Weight (lbs)	Neutral paint/ base price	Accent paint
 <p>Full-length door with coat rod on one side, 16.5" high hinged door insert, 1-6" box and 2-12" file drawers on other side. Comes with 3 locks.</p>	<b>ML2446E-B2F</b>	49 3/4"	24"	24"	145	\$2918	+\$294
	<b>ML3046E-B2F</b>	49 3/4"	30"	24"	162	\$3066	+\$308
	<b>MR2446E-B2F</b>	49 3/4"	24"	24"	145	\$2918	+\$294
	<b>MR3046E-B2F</b>	49 3/4"	30"	24"	162	\$3066	+\$308
 <p>Full-length door with coat rod on one side, 24" high hinged door insert with 1 shelf, 2-6" box and 1-10.5" file drawers on other side. Comes with 3 locks.</p>	<b>ML2446E-2BF10</b>	49 3/4"	24"	24"	145	\$3004	+\$302
	<b>ML3046E-2BF10</b>	49 3/4"	30"	24"	162	\$3151	+\$317
	<b>MR2446E-2BF10</b>	49 3/4"	24"	24"	145	\$3004	+\$302
	<b>MR3046E-2BF10</b>	49 3/4"	30"	24"	162	\$3151	+\$317
 <p>Full-length door with coat rod on one side, 24" high hinged door insert with 1 shelf, 1-10.5" and 1-12" file drawer on other side. Comes with 3 locks.</p>	<b>ML2446E-F10F</b>	49 3/4"	24"	24"	145	\$2791	+\$281
	<b>ML3046E-F10F</b>	49 3/4"	30"	24"	162	\$2940	+\$296
	<b>MR2446E-F10F</b>	49 3/4"	24"	24"	145	\$2791	+\$281
	<b>MR3046E-F10F</b>	49 3/4"	30"	24"	162	\$2940	+\$296
 <p>Full-length door with coat rod on one side, 27" high hinged door insert with 1 shelf, 1-7.5" box and 1-12" file drawer on other side. Comes with 3 locks.</p>	<b>ML2446E-B7F</b>	49 3/4"	24"	24"	145	\$2791	+\$281
	<b>ML3046E-B7F</b>	49 3/4"	30"	24"	162	\$2940	+\$296
	<b>MR2446E-B7F</b>	49 3/4"	24"	24"	145	\$2791	+\$281
	<b>MR3046E-B7F</b>	49 3/4"	30"	24"	162	\$2940	+\$296

### How to order

1. Specify product number.
2. Specify finish color.
3. Specify options.

### Product code key example

**MR2446E-PF10FK**

- M** Modular Series  
**R** right-handed door  
**24** tower width  
**46** interior height  
 **E** -9900 Series  
**P** pencil drawer  
**F10** 10 ½" file drawer  
**F** 12" file drawer  
**K** bookcase

### General information

Exterior cabinet heights are actual heights with glides fully recessed. Units containing pencil and/or box drawers include one pencil tray per unit. Each box drawer contains one steel divider. 10½" and 12" drawers have one sliding rail for side-to-side filing of letter size folders or printout binders. Hinged doors are standard with self closing European style hinges and open 110°.

### Counterweights

See Counterweight matrix on page 023.

### Lock option

Modular towers come standard with lock. If lock is not required add suffix '**NL**' after product number. Deduct \$50 list per lock.

### Accessories

Refer to Accessories section for options.

### Finishes

Refer to Finishes section for color options. Interior drawer bodies and shelves are finished in Eco Black. Bookshelves in side access towers are the same finish as the case.

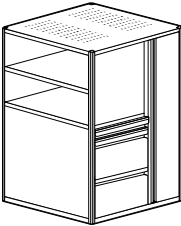
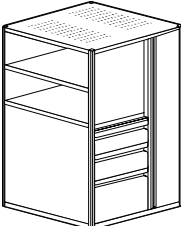
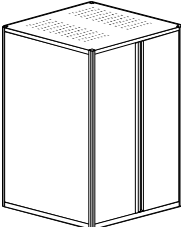
Description	Part number	Exterior height	Width	Depth	Weight (lbs)	Neutral paint/ base price	Accent paint
 <p>Full-length door with coat rod on one side, 19.5" high side access bookcase with 1 shelf, 1-3" pencil, 1-10.5" and 1-12" file drawer on the other side. Comes with 2 locks.</p>	<b>ML2446EPF10FK</b>	49 ¾"	24"	24"	150	\$2535	+\$255
	<b>ML3046EPF10FK</b> left-handed hinged door	49 ¾"	30"	24"	167	\$2669	+\$268
	<b>MR2446EPF10FK</b>	49 ¾"	24"	24"	150	\$2535	+\$255
	<b>MR3046EPF10FK</b> right-handed hinged door (illustrated)	49 ¾"	30"	24"	167	\$2669	+\$268
 <p>Full-length door with coat rod on one side, 19.5" high side access bookcase with 1 shelf, 1-6" box, 1-7.5" box and 1-12" file drawer on the other side. Comes with 2 locks.</p>	<b>ML2446E-BB7FK</b>	49 ¾"	24"	24"	150	\$2535	+\$255
	<b>ML3046E-BB7FK</b> left-handed hinged door	49 ¾"	30"	24"	167	\$2669	+\$268
	<b>MR2446E-BB7FK</b>	49 ¾"	24"	24"	150	\$2535	+\$255
	<b>MR3046E-BB7FK</b> right-handed hinged door (illustrated)	49 ¾"	30"	24"	167	\$2669	+\$268
 <p>Two full-length hinged doors. Coat rod on one side and shelves on the other. Comes with 2 locks.</p>	<b>MR2446E-HD</b>	49 ¾"	24"	24"	118	\$2076	+\$209
	<b>MR3046E-HD</b> coat rod on left side	49 ¾"	30"	24"	135	\$2209	+\$223
	<b>ML2446E-HD</b>	49 ¾"	24"	24"	118	\$2076	+\$209
	<b>ML3046E-HD</b> coat rod on right side	49 ¾"	30"	24"	135	\$2209	+\$223

# Towers

## Modular Towers Monolithic Units

### How to order

1. Specify product number.
2. Specify finish color.
3. Specify options.

### Product code key example

#### MR2458E-B3F

<b>M</b>	Modular Series
<b>R</b>	right-handed door
<b>24</b>	tower width
<b>58</b>	interior height
<b>E</b>	9900 Series
<b>B</b>	6" box drawer
<b>3</b>	number of drawers
<b>F</b>	12" file drawer

### General information

Exterior cabinet heights are actual heights with glides fully recessed. Units containing pencil and/or box drawers include one pencil tray per unit. Each box drawer contains one steel divider. 10½" and 12" drawers have one sliding rail for side-to-side filing of letter size folders or printout binders. Hinged doors are standard with self closing European style hinges and open 110°.

A hinged door insert includes a bottom shelf. This means that the insert door height and usable interior space is actually 1½" less than the heights noted in the descriptions.

### Counterweights

See Counterweight matrix on page 023.

### Lock option

Modular towers come standard with lock. If lock is not required add suffix 'NL' after product number. Deduct \$50 list per lock.

### Accessories

Refer to Accessories section for options.

### Finishes

Refer to Finishes section for color options. Interior drawer bodies and shelves are finished in Eco Black. Bookshelves in side access towers are the same finish as the case.

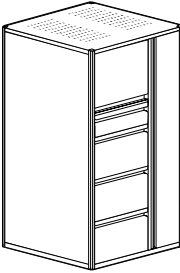
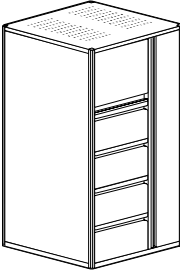
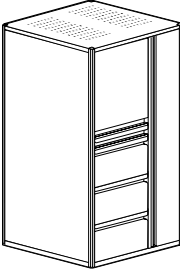
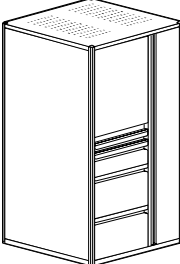
Description	Part number	Exterior height	Width	Depth	Weight (lbs)	Neutral paint/ base price	Accent paint
 <p>Full-length door with coat rod on one side, 16.5" high hinged door insert, 1-6" box and 3-12" file drawers on other side. Comes with 3 locks.</p>	<b>ML2458E-B3F</b>	61 ¾"	24"	24"	180	\$3166	+\$318
	<b>ML3058E-B3F</b> left-handed hinged door	61 ¾"	30"	24"	198	\$3651	+\$367
	<b>MR2458E-B3F</b>	61 ¾"	24"	24"	180	\$3166	+\$318
	<b>MR3058E-B3F</b> right-handed hinged door (illustrated)	61 ¾"	30"	24"	198	\$3651	+\$367
 <p>Full length door with coat rod on one side, 16.5" high hinged door insert and 4-10.5" file drawers on other side. Comes with 3 locks.</p>	<b>ML2458E-4F10</b>	61 ¾"	24"	24"	180	\$3166	+\$318
	<b>ML3058E-4F10</b> left-handed hinged door	61 ¾"	30"	24"	198	\$3651	+\$367
	<b>MR2458E-4F10</b>	61 ¾"	24"	24"	180	\$3166	+\$318
	<b>MR3058E-4F10</b> right-handed hinged door (illustrated)	61 ¾"	30"	24"	198	\$3651	+\$367
 <p>Full-length door with coat rod on one side, 24" high hinged door insert with 1 shelf, 1-3" pencil and 3-10.5" file drawers on other side. Comes with 3 locks.</p>	<b>ML2458E-P3F10</b>	61 ¾"	24"	24"	180	\$3196	+\$321
	<b>ML3058E-P3F10</b> left-handed hinged door	61 ¾"	30"	24"	198	\$3680	+\$369
	<b>MR2458E-P3F10</b>	61 ¾"	24"	24"	180	\$3196	+\$321
	<b>MR3058E-P3F10</b> right-handed hinged door (illustrated)	61 ¾"	30"	24"	198	\$3680	+\$369
 <p>Full-length door with coat rod on one side, 24" high hinged door insert with 1 shelf, 1-3" pencil, 1-7.5" box and 2-12" file drawers on other side. Comes with 3 locks.</p>	<b>ML2458E-PB72F</b>	61 ¾"	24"	24"	180	\$3196	+\$321
	<b>ML3058E-PB72F</b> left-handed hinged door	61 ¾"	30"	24"	198	\$3680	+\$369
	<b>MR2458E-PB72F</b>	61 ¾"	24"	24"	180	\$3196	+\$321
	<b>MR3058E-PB72F</b> right-handed hinged door (illustrated)	61 ¾"	30"	24"	198	\$3680	+\$369

### How to order

1. Specify product number.
2. Specify finish color.
3. Specify options.

### Product code key example

#### MR2458E-3F10

- M** Modular Series  
**R** right-handed door  
**24** tower width  
**58** interior height  
 **E** -9900 Series  
**3** number of drawers  
**F10** 10 ½" file drawer

### General information

Exterior cabinet heights are actual heights with glides fully recessed. Units containing pencil and/or box drawers include one pencil tray per unit. Each box drawer contains one steel divider. 10½" and 12" drawers have one sliding rail for side-to-side filing of letter size folders or printout binders. Hinged doors are standard with self closing European style hinges and open 110°.

A hinged door insert includes a bottom shelf. This means that the insert door height and usable interior space is actually 1½" less than the heights noted in the descriptions.

### Counterweights

See Counterweight matrix on page 023.

### Lock option

Modular towers come standard with lock. If lock is not required add suffix '**NL**' after product number. Deduct \$50 list per lock.

### Accessories

Refer to Accessories section for options.

### Finishes

Refer to Finishes section for color options. Interior drawer bodies and shelves are finished in Eco Black. Bookshelves in side access towers are the same finish as the case.

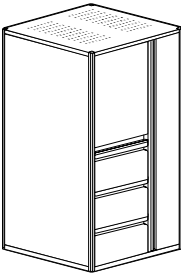
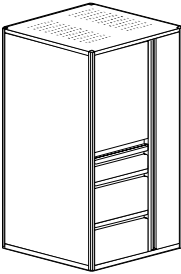
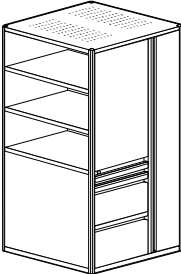
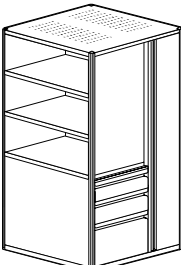
Description	Part number	Exterior height	Width	Depth	Weight (lbs)	Neutral paint/ base price	Accent paint
 <p>Full-length door with coat rod on one side, 27" high hinged door insert with 1 shelf and 3-10.5" file drawers on other side. Comes with 3 locks.</p>	<b>ML2458E-3F10</b>	61 ¾"	24"	24"	180	\$3124	+\$314
	<b>ML3058E-3F10</b> left-handed hinged door	61 ¾"	30"	24"	198	\$3600	+\$362
	<b>MR2458E-3F10</b>	61 ¾"	24"	24"	180	\$3124	+\$314
	<b>MR3058E-3F10</b> right-handed hinged door (illustrated)	61 ¾"	30"	24"	198	\$3600	+\$362
 <p>Full-length door with coat rod on one side, 25.5" high hinged door insert with 1 shelf, 1-7.5" box and 2-12" file drawers on other side. Comes with 3 locks.</p>	<b>ML2458E-B72F</b>	61 ¾"	24"	24"	180	\$3124	+\$314
	<b>ML3058E-B72F</b> left-handed hinged door	61 ¾"	30"	24"	198	\$3600	+\$362
	<b>MR2458E-B72F</b>	61 ¾"	24"	24"	180	\$3124	+\$314
	<b>MR3058E-B72F</b> right-handed hinged door (illustrated)	61 ¾"	30"	24"	198	\$3600	+\$362
 <p>Full-length door with coat rod on one side, 31.5" high side access bookcase with 2 shelves, 1-3" pencil, 1-10.5" and 1-12" file drawers on the other side. Comes with 2 locks.</p>	<b>ML2458EPF10FK</b>	61 ¾"	24"	24"	180	\$2654	+\$266
	<b>ML3058EPF10FK</b> left-handed hinged door	61 ¾"	30"	24"	198	\$2776	+\$279
	<b>MR2458EPF10FK</b>	61 ¾"	24"	24"	180	\$2654	+\$266
	<b>MR3058EPF10FK</b> right-handed hinged door (illustrated)	61 ¾"	30"	24"	198	\$2776	+\$279
 <p>Full length door with coat rod on one side, 31.5" high side access bookcase with 2 shelves, 1-6" box, 1-7.5" box and 1-12" file drawer on the other side. Comes with 2 locks.</p>	<b>ML2458E-BB7FK</b>	61 ¾"	24"	24"	180	\$2654	+\$266
	<b>ML3058E-BB7FK</b> left-handed hinged door	61 ¾"	30"	24"	198	\$2776	+\$279
	<b>MR2458E-BB7FK</b>	61 ¾"	24"	24"	180	\$2654	+\$266
	<b>MR3058E-BB7FK</b> right-handed hinged door (illustrated)	61 ¾"	30"	24"	198	\$2776	+\$279

# Towers

## Modular Towers Monolithic Units

### How to order

1. Specify product number.
2. Specify finish color.
3. Specify options.

### Product code key example

#### MR2460E-2B2F

<b>M</b>	Modular Series
<b>R</b>	right-handed door
<b>24</b>	tower width
<b>60</b>	interior height
<b>E</b>	9900 Series
<b>2</b>	number of drawers
<b>B</b>	6" box drawer
<b>2</b>	number of drawers
<b>F</b>	12" file drawer

### General information

Exterior cabinet heights are actual heights with glides fully recessed. Units containing pencil and/or box drawers include one pencil tray per unit. Each box drawer contains one steel divider. 10½" and 12" drawers have one sliding rail for side-to-side filing of letter size folders or printout binders. Hinged doors are standard with self closing European style hinges and open 110°.

A hinged door insert includes a bottom shelf. This means that the insert door height and usable interior space is actually 1 ½" less than the heights noted in the descriptions.

### Counterweights

See Counterweight matrix on page 023.

### Lock option

Modular towers come standard with lock. If lock is not required add suffix 'NL' after product number. Deduct \$50 list per lock.

### Accessories

Refer to Accessories section for options.

### Finishes

Refer to Finishes section for color options. Interior drawer bodies and shelves are finished in Eco Black. Bookshelves in side access towers are the same finish as the case.

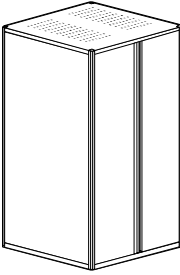
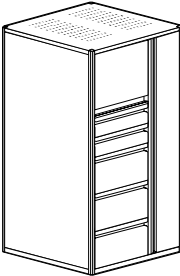
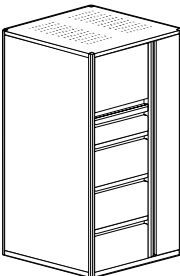
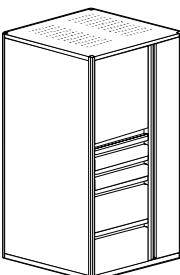
Description	Part number	Exterior height	Width	Depth	Weight (lbs)	Neutral paint/ base price	Accent paint
 <p>Two full-length hinged doors. Coat rod on one side and shelves on the other side. Comes with 2 locks.</p>	<b>ML2458E-HD</b>	61 ¾"	24"	24"	140	\$2130	+\$215
	<b>ML3058E-HD</b> coat rod on left side	61 ¾"	30"	24"	168	\$2286	+\$230
	<b>MR2458E-HD</b>	61 ¾"	24"	24"	140	\$2130	+\$215
	<b>MR3058E-HD</b> coat rod on right side	61 ¾"	30"	24"	168	\$2286	+\$230
 <p>Full-length door with coat rod on one side, 16.5" high hinged door insert, 2-6" box and 3-10.5" file drawers on other side. Comes with 3 locks.</p>	<b>ML2460E-2B3F10</b>	63 ¼"	24"	24"	180	\$3375	+\$338
	<b>ML3060E-2B3F10</b> left-handed hinged door	63 ¼"	30"	24"	198	\$3875	+\$389
	<b>MR2460E-2B3F10</b>	63 ¼"	24"	24"	180	\$3375	+\$338
	<b>MR3060E-2B3F10</b> right-handed hinged door (illustrated)	63 ¼"	30"	24"	198	\$3875	+\$389
 <p>Full-length door with coat rod on one side, 15" high hinged door insert, 1-7.5" box and 3-12" file drawers on other side. Comes with 3 locks.</p>	<b>ML2460E-B73F</b>	63 ¼"	24"	24"	180	\$3166	+\$318
	<b>ML3060E-B73F</b> left-handed hinged door	63 ¼"	30"	24"	198	\$3651	+\$367
	<b>MR2460E-B73F</b>	63 ¼"	24"	24"	180	\$3166	+\$318
	<b>MR3060E-B73F</b> right-handed hinged door (illustrated)	63 ¼"	30"	24"	198	\$3651	+\$367
 <p>Full-length door with coat rod on one side, 24" high hinged door insert with 1 shelf, 2-6" box and 2-12" file drawers on other side. Comes with 3 locks.</p>	<b>ML2460E-2B2F</b>	63 ¼"	24"	24"	180	\$3196	+\$321
	<b>ML3060E-2B2F</b> left-handed hinged door	63 ¼"	30"	24"	198	\$3680	+\$369
	<b>MR2460E-2B2F</b>	63 ¼"	24"	24"	180	\$3196	+\$321
	<b>MR3060E-2B2F</b> right-handed hinged door (illustrated)	63 ¼"	30"	24"	198	\$3680	+\$369

## How to order

1. Specify product number.
2. Specify finish color.
3. Specify options.

## Product code key example

### MR2460E-3F

<b>M</b>	Modular Series
<b>R</b>	right-handed door
<b>24</b>	tower width
<b>60</b>	interior height
<b>E</b>	9900 Series
<b>3</b>	number of drawers
<b>F</b>	12" file drawer

## General information

Exterior cabinet heights are actual heights with glides fully recessed. Units containing pencil and/or box drawers include one pencil tray per unit. Each box drawer contains one steel divider. 10½" and 12" drawers have one sliding rail for side-to-side filing of letter size folders or printout binders. Hinged doors are standard with self closing European style hinges and open 110°.

A hinged door insert includes a bottom shelf. This means that the insert door height and usable interior space is actually 1 ½" less than the heights noted in the descriptions.

## Counterweights

See Counterweight matrix on page 023.

## Lock option

Modular towers come standard with lock. If lock is not required add suffix 'NL' after product number. Deduct \$50 list per lock.

## Accessories

Refer to Accessories section for options.

## Finishes

Refer to Finishes section for color options. Interior drawer bodies and shelves are finished in Eco Black. Bookshelves in side access towers are the same finish as the case.

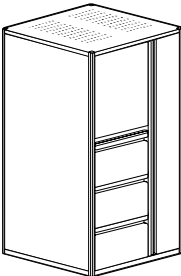
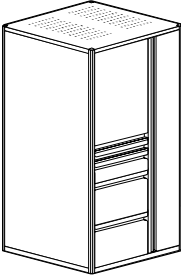
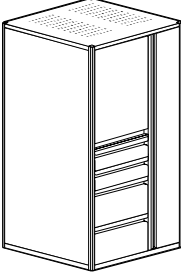
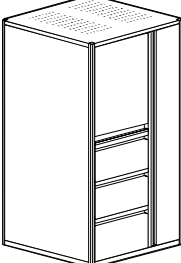
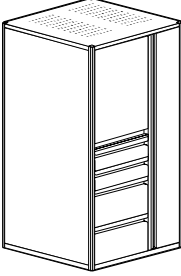
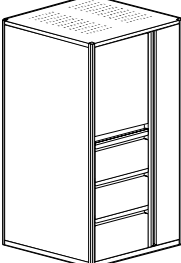
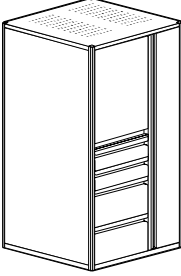
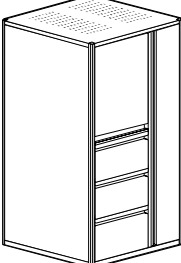
Description	Part number	Exterior height	Width	Depth	Weight (lbs)	Neutral paint/ base price	Accent paint	
 <p>Full-length door with coat rod on one side, 24" high hinged door insert with 1 shelf and 3-12" file drawers on other side. Comes with 3 locks.</p>	<b>ML2460E-3F</b>	63 ¼"	24"	24"	180	\$3124	+\$314	
	<b>ML3060E-3F</b>	63 ¼"	30"	24"	198	\$3600	+\$362	
	<i>left-handed hinged door</i>							
	<b>MR2460E-3F</b>	63 ¼"	24"	24"	180	\$3124	+\$314	
 <p>Full-length door with coat rod on one side, 24" high hinged door insert with 1 shelf and 3-12" file drawers on other side. Comes with 3 locks.</p>	<b>MR3060E-3F</b>	63 ¼"	30"	24"	198	\$3600	+\$362	
	<i>right-handed hinged door (illustrated)</i>							
	 <p>Full-length door with coat rod on one side, 27" high hinged door insert with 1 shelf, 1-3" pencil, 1-6" box and 2-12" file drawers on other side. Comes with 3 locks.</p>	<b>ML2460E-PB2F</b>	63 ¼"	24"	24"	180	\$3196	+\$321
		<b>ML3060E-PB2F</b>	63 ¼"	30"	24"	198	\$3680	+\$369
<i>left-handed hinged door</i>								
<b>MR2460E-PB2F</b>		63 ¼"	24"	24"	180	\$3196	+\$321	
 <p>Full-length door with coat rod on one side, 27" high hinged door insert with 1 shelf, 1-3" pencil, 1-6" box and 2-12" file drawers on other side. Comes with 3 locks.</p>	<b>MR3060E-PB2F</b>	63 ¼"	30"	24"	198	\$3680	+\$369	
	<i>right-handed hinged door (illustrated)</i>							
	 <p>Full-length door with coat rod on one side, 27" high hinged door insert with 1 shelf, 2-6" box and 2-10.5" file drawers on other side. Comes with 3 locks.</p>	<b>ML2460E2B2F10</b>	63 ¼"	24"	24"	180	\$3196	+\$321
		<b>ML3060E2B2F10</b>	63 ¼"	30"	24"	198	\$3680	+\$369
<i>left-handed hinged door</i>								
<b>MR2460E2B2F10</b>		63 ¼"	24"	24"	180	\$3196	+\$321	
 <p>Full-length door with coat rod on one side, 27" high hinged door insert with 1 shelf, 2-10.5" and 1-12" file drawers on other side. Comes with 3 locks.</p>	<b>MR3060E2B2F10</b>	63 ¼"	30"	24"	198	\$3680	+\$369	
	<i>right-handed hinged door (illustrated)</i>							
	 <p>Full-length door with coat rod on one side, 25.5" high hinged door insert with 1 shelf, 2-10.5" and 1-12" file drawer on other side. Comes with 3 locks.</p>	<b>ML2460E-2F10F</b>	63 ¼"	24"	24"	180	\$3124	+\$314
		<b>ML3060E-2F10F</b>	63 ¼"	30"	24"	198	\$3600	+\$362
<i>left-handed hinged door</i>								
<b>MR2460E-2F10F</b>		63 ¼"	24"	24"	180	\$3124	+\$314	
 <p>Full-length door with coat rod on one side, 25.5" high hinged door insert with 1 shelf, 2-10.5" and 1-12" file drawer on other side. Comes with 3 locks.</p>	<b>MR3060E-2F10F</b>	63 ¼"	30"	24"	198	\$3600	+\$362	
	<i>right-handed hinged door (illustrated)</i>							



# Towers

## Modular Towers Monolithic Units

### How to order

1. Specify product number.
2. Specify finish color.
3. Specify options.

### Product code key example

#### MR2460E-P10FK

- M** Modular Series  
**R** right-handed door  
**24** tower width  
**60** interior height  
**E** 9900 Series  
**P** pencil drawer  
**F10** 10 1/2" file drawer  
**F** 12" file drawer  
**K** bookcase

### General information

Exterior cabinet heights are actual heights with glides fully recessed. Units containing pencil and/or box drawers include one pencil tray per unit. Each box drawer contains one steel divider. 10 1/2" and 12" drawers have one sliding rail for side-to-side filing of letter size folders or printout binders. Hinged doors are standard with self closing European style hinges and open 110°.

### Counterweights

See Counterweight matrix on page 023.

### Lock option

Modular towers come standard with lock. If lock is not required add suffix 'NL' after product number. Deduct \$50 list per lock.

### Accessories

Refer to Accessories section for options.

### Finishes

Refer to Finishes section for color options. Interior drawer bodies and shelves are finished in Eco Black. Bookshelves in side access towers are the same finish as the case.

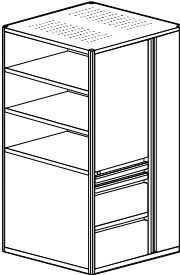
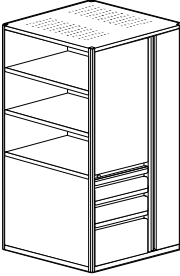
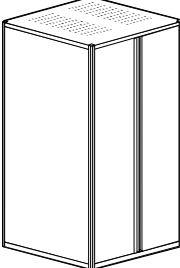
Description	Part number	Exterior height	Width	Depth	Weight (lbs)	Neutral paint/ base price	Accent paint
 <p>Full-length door with coat rod on one side, 33" high side access bookcase with 2 shelves, 1-3" pencil, 1-10.5" and 1-12" file drawer on the other side. Comes with 2 shelves. Comes with 2 locks.</p>	<b>ML2460EPF10FK</b>	63 1/4"	24"	24"	180	\$2655	+\$266
	<b>ML3060EPF10FK</b> left-handed hinged door	63 1/4"	30"	24"	198	\$2779	+\$279
	<b>MR2460EPF10FK</b>	63 1/4"	24"	24"	180	\$2655	+\$266
	<b>MR3060EPF10FK</b> right-handed hinged door (illustrated)	63 1/4"	30"	24"	198	\$2779	+\$279
 <p>Full-length door on with coat rod one side, 33" high side access bookcase with 2 shelves, 1-6" box, 1-7.5" box and 1-12" file drawer on other side. Comes with 2 locks.</p>	<b>ML2460E-BB7FK</b>	63 1/4"	24"	24"	180	\$2655	+\$266
	<b>ML3060E-BB7FK</b> left-handed hinged door	63 1/4"	30"	24"	198	\$2779	+\$279
	<b>MR2460E-BB7FK</b>	63 1/4"	24"	24"	180	\$2655	+\$266
	<b>MR3060E-BB7FK</b> right-handed hinged door (illustrated)	63 1/4"	30"	24"	198	\$2779	+\$279
 <p>Two full-length hinged doors. Coat rod on one side and shelves on the other. Comes with 2 locks.</p>	<b>ML2460E-HD</b>	63 1/4"	24"	24"	140	\$2130	+\$215
	<b>ML3060E-HD</b> coat rod on left side	63 1/4"	30"	24"	168	\$2286	+\$230
	<b>MR2460E-HD</b>	63 1/4"	24"	24"	140	\$2130	+\$215
	<b>MR3060E-HD</b> coat rod on right side	63 1/4"	30"	24"	168	\$2286	+\$230

## Construction

Cabinets are of all-welded construction using high quality, tension leveled cold rolled steel. The steel gauges selected for drawer fronts, bodies and accessories ensure the highest quality durability and performance for all components.

## Construction features & benefits

1. All interiors are modular and interchangeable so that cabinets can be retrofitted with new accessories and interiors as required.
2. Corners are strengthened with a reinforcing gusset and are welded at junction of top and case fronts, eliminating horizontal lines for a cleaner, flush appearance on the face of the cabinet.
3. Absence of scissor mechanism in doors and drawers eliminates the potential for scissors binding and facilitates reconfiguration of cabinet openings as needed.
4. Units have sound-absorbing materials for quieter operation – a particular asset in open plan environments.
5. Box drawer sides are slotted on 1" centers to allow for maximum flexibility for drawer division.
6. Box drawer side double-wall construction provides clean appearance and enclosed divider slots.
7. File drawer bodies have full-height sides to accommodate hanging file folders, eliminating the need for optional file frames.
8. Front leading edge of fixed shelf is flat for easy removal of material.
9. Fully-progressive ball bearing suspensions are staged so that left and right sides work in unison. This provides smooth drawer operation with minimum force.
10. Special "claw-like" device incorporated in suspensions "grips" the fixed section of the suspension arm preventing drawer bounce-back or creep when drawer is closed.
11. Lock fingers are configured with right angle bend upward, not downward, so that lift-up doors cannot be pulled down to disengage fingers from door slots and be forced to circumvent lock system.
12. Shorter hinged door unit is equipped with one adjustable shelf, slotted on 1" centers for dividers.
13. Self-closing, 110° opening, European style cupboard hinges provide smooth hinged door operation. Hinges are not visible from the exterior of the cabinet.
14. All Towers and Lockers, with the exception of the 26 7/8" high locker, have ventilation holes in the top of the cabinet to enhance air circulation within the full-height door and the shorter hinged door sections.
15. 30" and 36" wide Lockers and Towers have ventilation holes along the length of the full-height door. The liner or inside of the front is offset to eliminate sight-lines into the cabinet. 24" and 42" wide Lockers and Towers do not have ventilation holes in the full-height door.
16. Lock bars operate vertically on both sides of the cabinet for maximum security.

## Drawer construction

9900 Series fronts have full width integral pulls with enamel finish to match case fronts.

## Safelock™

The patented Safelock mechanism is standard on the 42" wide Locker and on Towers and Lockers that have more than one file (10 1/2" and 12") drawer. It provides complete security against accidental opening of two or more drawers simultaneously. When any drawer is extended, even fractionally, Safelock ensures that all other openings immediately become inoperable.

## Counterweights

See Counterweight matrix on page 023.

## Drawer standard equipment

Lockers and Towers containing 3" or 6" drawers are provided with one pencil tray per cabinet. 6" drawers are additionally standard with one steel divider. 10 1/2", 12" and 15" letter-width file drawers have one suspension bar for side-to-side filing of letter or legal-size folders.

Full-width pullout drawers are standard with one pair hangfile bars for side-to-side suspended filing. Full-width fixed shelves are standard with 3 plate dividers. Optional accessories are available.

## Glides

Overall heights are inclusive of metal glides. Heights may be increased up to 3/8" by extending standard glide. Glides are accessible from inside the cabinet when the bottom drawer is fully extended or removed and may be adjusted with a 1/4" socket driver.

Optional 1 1/2" stem glides are available. Specify separately and add \$26 list to the cabinet price. Requires field installation.

## Locks

Workplace Towers and Lockers come standard with lock. If lock is not required add suffix '/NL' after product number.

Deduct \$50 list per lock. For lock location, see guide at the beginning of this price list. Locks are available in Chrome and Black finish. Specify.

Random keying is standard. Files may be ordered keyed alike. Specify. Locks feature removable core and are standard with two keys, one of which has a black neoprene plastic key cover.

Cabinets originally ordered as non-locking may be field installed with the addition of locking bars and a lock core. Please contact Inscope Client Services for required parts. Specify lateral file height and width or model number.

Master keys are available at \$45 list.

## Finishes

Refer to the Finishes section of this price list.



# Towers

## Workplace Towers and Lockers

### Wardrobes

#### How to order

1. Specify product number.
2. Specify case finish.
3. Specify front finish.
4. Specify options.

#### Product code key example

**VL121839□-HD**

- V** wardrobe  
**L** left handed  
**12** cabinet width  
**18** nominal cabinet depth  
**39** interior height  
**E** 9900 Series  
**HD** hinged door

**NOTE: Pricing for Drawer pull FP001 is standard. For additional pulls review pull option chart.**

#### General information

Exterior cabinet heights are nominal. Actual heights (with glides fully recessed) are 1/8" less.

Adding rectangular glides increases exterior height.

Hinged doors are standard with self-closing European style hinges that open 110°. Shelves are slotted every 1 1/2" and are height adjustable in 1 1/2" increments. Shelf dividers are not included. See Accessories section.

#### Accessories

See Accessories section for counterweights and accessories.

#### Lock option

Wardrobes come standard with lock.

If lock is not required add suffix 'NL' after product number. Deduct \$50 list per lock.

#### Finishes

Refer to Finishes section for color options. Interior drawer bodies and shelves are finished in Eco Black.

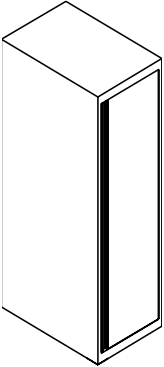
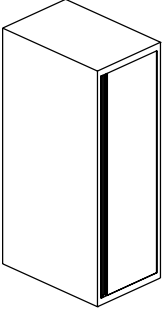
Description	Part number	Height	Width	Depth	Flat glides		Rectangular glides	Accent paint
					Coat rod + shelf/ Neutral paint	Shelves/ Neutral paint		
 <p>9900 Series Wardrobe Tower to match 44" h panel</p>	<b>VL121839E-HD</b>	41 7/8"	12"	18"	\$1164	\$1164	+\$29	+\$118
	<b>VL122439E-HD</b>	41 7/8"	12"	24"	\$1255	\$1255	+\$29	+\$126
	<b>VL151839E-HD</b>	41 7/8"	15"	18"	\$1255	\$1255	+\$29	+\$126
	<b>VL152439E-HD</b>	41 7/8"	15"	24"	\$1292	\$1292	+\$29	+\$130
	<b>VL181839E-HD</b>	41 7/8"	18"	18"	\$1292	\$1292	+\$29	+\$130
	<b>VL182439E-HD</b>	41 7/8"	18"	24"	\$1306	\$1306	+\$29	+\$131
	left-handed hinged door							
	<b>VR121839E-HD</b>	41 3/8"	12"	18"	\$1164	\$1164	+\$29	+\$118
	<b>VR122439E-HD</b>	41 3/8"	12"	24"	\$1255	\$1255	+\$29	+\$126
	<b>VR151839E-HD</b>	41 3/8"	15"	18"	\$1255	\$1255	+\$29	+\$126
	<b>VR152439E-HD</b>	41 3/8"	15"	24"	\$1292	\$1292	+\$29	+\$130
	<b>VR181839E-HD</b>	41 3/8"	18"	18"	\$1292	\$1292	+\$29	+\$130
	<b>VR182439E-HD</b>	41 3/8"	18"	24"	\$1306	\$1306	+\$29	+\$131
	right-handed hinged door (illustrated)							
 <p>9900 Series Wardrobe Tower to match 51" h panel</p>	<b>VL121846E-HD</b>	49 3/8"	12"	18"	\$1259	\$1259	+\$29	+\$127
	<b>VL122446E-HD</b>	49 3/8"	12"	24"	\$1329	\$1329	+\$29	+\$133
	<b>VL151846E-HD</b>	49 3/8"	15"	18"	\$1329	\$1329	+\$29	+\$133
	<b>VL152446E-HD</b>	49 3/8"	15"	24"	\$1403	\$1403	+\$29	+\$143
	<b>VL181846E-HD</b>	49 3/8"	18"	18"	\$1403	\$1403	+\$29	+\$143
	<b>VL182446E-HD</b>	49 3/8"	18"	24"	\$1478	\$1478	+\$29	+\$150
	left-handed hinged door							
	<b>VR121846E-HD</b>	49 3/8"	12"	18"	\$1259	\$1259	+\$29	+\$127
	<b>VR122446E-HD</b>	49 3/8"	12"	24"	\$1329	\$1329	+\$29	+\$133
	<b>VR151846E-HD</b>	49 3/8"	15"	18"	\$1329	\$1329	+\$29	+\$133
	<b>VR152446E-HD</b>	49 3/8"	15"	24"	\$1403	\$1403	+\$29	+\$143
	<b>VR181846E-HD</b>	49 3/8"	18"	18"	\$1403	\$1403	+\$29	+\$143
	<b>VR182446E-HD</b>	49 3/8"	18"	24"	\$1478	\$1478	+\$29	+\$150
	right-handed hinged door (illustrated)							

### How to order

1. Specify product number.
2. Specify case finish.
3. Specify front finish.
4. Specify options.

### Product code key example

**VL121852□-HD**

- V** wardrobe
- L** left handed
- 12** cabinet width
- 18** nominal cabinet depth
- 52** interior height
- E** 9900 Series
- HD** hinged door

**NOTE: Pricing for Drawer pull FP001 is standard. For additional pulls review pull option chart.**

### General information

Exterior cabinet heights are nominal. Actual heights (with glides fully recessed) are 1/8" less.

Adding rectangular glides increases exterior height.

Hinged doors are standard with self-closing European style hinges that open 110°.

Shelves are slotted every 1 1/2" and are height adjustable in 1 1/2" increments. Shelf dividers are not included. See Accessories section.

### Accessories

See Accessories section for counterweights and accessories.

### Lock option

Wardrobes come standard with lock.

If lock is not required add suffix 'NL' after product number. Deduct \$50 list per lock.

### Finishes

Refer to Finishes section for color options.

Interior drawer bodies and shelves are finished in Eco Black.

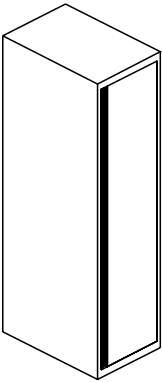
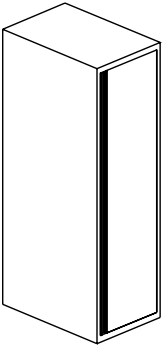
Description	Part number	Height	Width	Depth	Flat glides		Rectangular glides	Accent paint
					Coat rod + shelf/ Neutral paint	Shelves/ Neutral paint		
 <p>9900 Series Wardrobe Tower to match 57" h panel</p>	<b>VL121852E-HD</b>	55 3/8"	12"	18"	\$1369	\$1369	+\$29	+\$137
	<b>VL122452E-HD</b>	55 3/8"	12"	24"	\$1417	\$1417	+\$29	+\$144
	<b>VL151852E-HD</b>	55 3/8"	15"	18"	\$1417	\$1417	+\$29	+\$144
	<b>VL152452E-HD</b>	55 3/8"	15"	24"	\$1467	\$1467	+\$29	+\$149
	<b>VL181852E-HD</b>	55 3/8"	18"	18"	\$1467	\$1467	+\$29	+\$149
	<b>VL182452E-HD</b>	55 3/8"	18"	24"	\$1516	\$1516	+\$29	+\$153
	left-handed hinged door							
	<b>VR121852E-HD</b>	55 3/8"	12"	18"	\$1369	\$1369	+\$29	+\$137
	<b>VR122452E-HD</b>	55 3/8"	12"	24"	\$1417	\$1417	+\$29	+\$144
	<b>VR151852E-HD</b>	55 3/8"	15"	18"	\$1417	\$1417	+\$29	+\$144
	<b>VR152452E-HD</b>	55 3/8"	15"	24"	\$1467	\$1467	+\$29	+\$149
	<b>VR181852E-HD</b>	55 3/8"	18"	18"	\$1467	\$1467	+\$29	+\$149
	<b>VR182452E-HD</b>	55 3/8"	18"	24"	\$1516	\$1516	+\$29	+\$153
	right-handed hinged door (illustrated)							
 <p>9900 Series Wardrobe Tower to match 64" h panel</p>	<b>VL121860E-HD</b>	62 7/8"	12"	18"	\$1399	\$1399	+\$29	+\$142
	<b>VL122460E-HD</b>	62 7/8"	12"	24"	\$1478	\$1478	+\$29	+\$150
	<b>VL151860E-HD</b>	62 7/8"	15"	18"	\$1478	\$1478	+\$29	+\$150
	<b>VL152460E-HD</b>	62 7/8"	15"	24"	\$1520	\$1520	+\$29	+\$154
	<b>VL181860E-HD</b>	62 7/8"	18"	18"	\$1520	\$1520	+\$29	+\$154
	<b>VL182460E-HD</b>	62 7/8"	18"	24"	\$1563	\$1563	+\$29	+\$158
	left-handed hinged door							
	<b>VR121860E-HD</b>	62 7/8"	12"	18"	\$1399	\$1399	+\$29	+\$142
	<b>VR122460E-HD</b>	62 7/8"	12"	24"	\$1478	\$1478	+\$29	+\$150
	<b>VR151860E-HD</b>	62 7/8"	15"	18"	\$1478	\$1478	+\$29	+\$150
	<b>VR152460E-HD</b>	62 7/8"	15"	24"	\$1520	\$1520	+\$29	+\$154
	<b>VR181860E-HD</b>	62 7/8"	18"	18"	\$1520	\$1520	+\$29	+\$154
	<b>VR182460E-HD</b>	62 7/8"	18"	24"	\$1563	\$1563	+\$29	+\$158
	right-handed hinged door (illustrated)							

# Towers

## Workplace Towers and Lockers Wardrobes

### How to order

1. Specify product number.
2. Specify case finish.
3. Specify front finish.
4. Specify options.

### Product code key example

**VL121839□-HD**

- V** wardrobe  
**L** left handed  
**12** cabinet width  
**18** nominal cabinet depth  
**39** interior height  
**E** 9900 Series  
**HD** hinged door

**NOTE: Pricing for Drawer pull FP001 is standard. For additional pulls review pull option chart.**

### General information

Exterior cabinet heights are nominal. Actual heights (with glides fully recessed) are 1/8" less.

Hinged doors are standard with self-closing European style hinges that open 110°.

Shelves are slotted every 1 1/2" and are height adjustable in 1 1/2" increments. Shelf dividers are not included. See Accessories section.

### Accessories

See Accessories section for counterweights and accessories.

### Lock option

Wardrobes come standard with lock.

If lock is not required add suffix 'NL' after product number. Deduct \$50 list per lock.

**Nuform Wardrobes are available with an eLock option. Add \$368 to list price for eLock.**

### Finishes

Refer to Finishes section for finish options for case, Nuform Woodgrain fronts. Drawer bodies and accessories are finished in Eco Black.

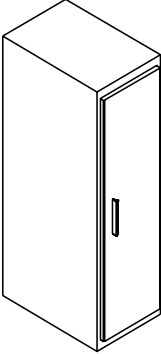
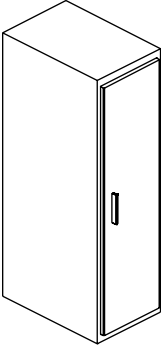
Description	Part number	Height	Width	Depth	Flat glides		Rectangular glides	Accent paint
					Coat rod + shelf/ Neutral paint	Shelves/ Neutral paint		
 <p>Nuform Wardrobe Tower to match 44" h panel eLock option available</p>	<b>VL121839Q-HD</b>	41 7/8"	12"	18"	\$1399	\$1378	+\$29	+\$142
	<b>VL122439Q-HD</b>	41 7/8"	12"	24"	\$1507	\$1485	+\$29	+\$153
	<b>VL151839Q-HD</b>	41 7/8"	15"	18"	\$1507	\$1485	+\$29	+\$153
	<b>VL152439Q-HD</b>	41 7/8"	15"	24"	\$1550	\$1526	+\$29	+\$157
	<b>VL181839Q-HD</b>	41 7/8"	18"	18"	\$1550	\$1526	+\$29	+\$157
	<b>VL182439Q-HD</b>	41 7/8"	18"	24"	\$1566	\$1399	+\$29	+\$158
	left-handed hinged door							
	<b>VR121839Q-HD</b>	41 3/8"	12"	18"	\$1399	\$1507	+\$29	+\$142
	<b>VR122439Q-HD</b>	41 3/8"	12"	24"	\$1507	\$1507	+\$29	+\$153
	<b>VR151839Q-HD</b>	41 3/8"	15"	18"	\$1507	\$1550	+\$29	+\$153
	<b>VR152439Q-HD</b>	41 3/8"	15"	24"	\$1550	\$1550	+\$29	+\$157
	<b>VR181839Q-HD</b>	41 3/8"	18"	18"	\$1550	\$1566	+\$29	+\$157
<b>VR182439Q-HD</b>	41 3/8"	18"	24"	\$1566	\$1399	+\$29	+\$158	
right-handed hinged door (illustrated)								
 <p>Nuform Wardrobe Tower to match 51" h panel eLock option available</p>	<b>VL121846Q-HD</b>	49 3/8"	12"	18"	\$1512	\$1507	+\$29	+\$153
	<b>VL122446Q-HD</b>	49 3/8"	12"	24"	\$1594	\$1507	+\$29	+\$161
	<b>VL151846Q-HD</b>	49 3/8"	15"	18"	\$1594	\$1550	+\$29	+\$161
	<b>VL152446Q-HD</b>	49 3/8"	15"	24"	\$1681	\$1550	+\$29	+\$169
	<b>VL181846Q-HD</b>	49 3/8"	18"	18"	\$1681	\$1566	+\$29	+\$169
	<b>VL182446Q-HD</b>	49 3/8"	18"	24"	\$1774	\$1512	+\$29	+\$179
	left-handed hinged door							
	<b>VR121846Q-HD</b>	49 3/8"	12"	18"	\$1512	\$1594	+\$29	+\$153
	<b>VR122446Q-HD</b>	49 3/8"	12"	24"	\$1594	\$1594	+\$29	+\$161
	<b>VR151846Q-HD</b>	49 3/8"	15"	18"	\$1594	\$1681	+\$29	+\$161
	<b>VR152446Q-HD</b>	49 3/8"	15"	24"	\$1681	\$1681	+\$29	+\$169
	<b>VR181846Q-HD</b>	49 3/8"	18"	18"	\$1681	\$1774	+\$29	+\$169
<b>VR182446Q-HD</b>	49 3/8"	18"	24"	\$1774	\$1512	+\$29	+\$179	
right-handed hinged door (illustrated)								

### How to order

1. Specify product number.
2. Specify case finish.
3. Specify front finish.
4. Specify options.

### Product code key example

**VL121839□-HD**

- V** wardrobe
- L** left handed
- 12** cabinet width
- 18** nominal cabinet depth
- 39** interior height
- E** 9900 Series
- HD** hinged door

**NOTE: Pricing for Drawer pull FP001 is standard. For additional pulls review pull option chart.**

### General information

Exterior cabinet heights are nominal. Actual heights (with glides fully recessed) are 1/8" less.

Hinged doors are standard with self-closing European style hinges that open 110°.

Shelves are slotted every 1 1/2" and are height adjustable in 1 1/2" increments. Shelf dividers are not included. See Accessories section.

### Accessories

See Accessories section for counterweights and accessories.

### Lock option

Wardrobes come standard with lock.

If lock is not required add suffix '/NL' after product number. Deduct \$50 list per lock.

**Nuform Wardrobes are available with an eLock option. Add \$368 to list price for eLock.**

### Finishes

Refer to Finishes section for finish options for case, Nuform Woodgrain fronts. Drawer bodies and accessories are finished in Eco Black.

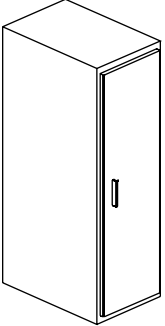
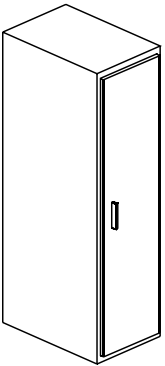
Description	Part number	Height	Width	Depth	Flat glides			
					Coat rod + shelf/ Neutral paint	Shelves/ Neutral paint	Rectangular glides	Accent paint
 <p>Nuform Wardrobe Tower to match 57" h panel eLock option available</p>	<b>VL121852Q-HD</b>	55 3/8"	12"	18"	\$1643	\$1594	+\$29	+\$166
	<b>VL122452Q-HD</b>	55 3/8"	12"	24"	\$1700	\$1594	+\$29	+\$171
	<b>VL151852Q-HD</b>	55 3/8"	15"	18"	\$1700	\$1681	+\$29	+\$171
	<b>VL152452Q-HD</b>	55 3/8"	15"	24"	\$1758	\$1681	+\$29	+\$177
	<b>VL181852Q-HD</b>	55 3/8"	18"	18"	\$1758	\$1774	+\$29	+\$177
	<b>VL182452Q-HD</b>	55 3/8"	18"	24"	\$1818	\$1643	+\$29	+\$183
	left-handed hinged door							
	<b>VR121852Q-HD</b>	55 3/8"	12"	18"	\$1643	\$1700	+\$29	+\$166
	<b>VR122452Q-HD</b>	55 3/8"	12"	24"	\$1700	\$1700	+\$29	+\$171
	<b>VR151852Q-HD</b>	55 3/8"	15"	18"	\$1700	\$1758	+\$29	+\$171
	<b>VR152452Q-HD</b>	55 3/8"	15"	24"	\$1758	\$1758	+\$29	+\$177
	<b>VR181852Q-HD</b>	55 3/8"	18"	18"	\$1758	\$1818	+\$29	+\$177
	<b>VR182452Q-HD</b>	55 3/8"	18"	24"	\$1818	\$1643	+\$29	+\$183
	right-handed hinged door (illustrated)							
 <p>Nuform Wardrobe Tower to match 64" h panel eLock option available</p>	<b>VL121860Q-HD</b>	62 7/8"	12"	18"	\$1678	\$1700	+\$29	+\$169
	<b>VL122460Q-HD</b>	62 7/8"	12"	24"	\$1774	\$1700	+\$29	+\$179
	<b>VL151860Q-HD</b>	62 7/8"	15"	18"	\$1774	\$1758	+\$29	+\$179
	<b>VL152460Q-HD</b>	62 7/8"	15"	24"	\$1825	\$1758	+\$29	+\$184
	<b>VL181860Q-HD</b>	62 7/8"	18"	18"	\$1825	\$1818	+\$29	+\$184
	<b>VL182460Q-HD</b>	62 7/8"	18"	24"	\$1874	\$1678	+\$29	+\$189
	left-handed hinged door							
	<b>VR121860Q-HD</b>	62 7/8"	12"	18"	\$1678	\$1774	+\$29	+\$169
	<b>VR122460Q-HD</b>	62 7/8"	12"	24"	\$1774	\$1774	+\$29	+\$179
	<b>VR151860Q-HD</b>	62 7/8"	15"	18"	\$1774	\$1825	+\$29	+\$179
	<b>VR152460Q-HD</b>	62 7/8"	15"	24"	\$1825	\$1825	+\$29	+\$184
	<b>VR181860Q-HD</b>	62 7/8"	18"	18"	\$1825	\$1874	+\$29	+\$184
	<b>VR182460Q-HD</b>	62 7/8"	18"	24"	\$1874	\$1678	+\$29	+\$189
	right-handed hinged door (illustrated)							

# Towers

## Workplace Towers and Lockers

Towers

### How to order

1. Specify product number.
2. Specify finish color.
3. Specify options.

### Product code key example

#### TR24405E-PF10

- T** Workplace Tower  
**R** right-handed door  
**24** tower width  
**405** interior height  
**E** 9900 Series  
**P** pencil drawer  
**F10** 10 ½" file drawer

### General information

Exterior cabinet heights are nominal. Actual heights (with glides fully recessed) are ⅛" less. Units containing pencil and/or box drawers include one pencil tray per unit. Each box drawer contains one steel divider. 10½" and 12" drawers have one sliding rail for side-to-side filing of letter size folders or printout binders. Hinged doors are standard with self closing European style hinges and open 110°.

A hinged door insert includes a bottom shelf. This means that the insert door height and usable interior space is actually 1 ½" less than the heights noted in the descriptions.

### Counterweights



See Counterweight matrix on page 023.

### Lock option

Workplace towers come standard with lock. If lock is not required add suffix 'NL' after product number. Deduct \$50 list per lock.

### Finishes

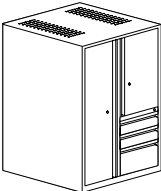
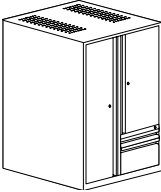
Refer to Finishes section for color options. Interior drawer bodies and shelves are finished in Eco Black. Bookshelves in side access towers are the same finish as the case.

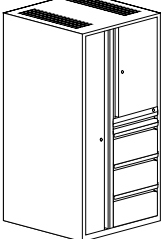
Description	Part number	Exterior height	Width	Depth	Weight (lbs)	Neutral paint/ base price	Accent paint
 <p>Full-length door 9" wide on one side, 16.5" high hinged door insert, 2-6" box and 1-12" file drawers on other side. Can be specified with/without mobile file kit.</p>	<b>TL24405E-2BF</b>	43 ⅜"	24"	24"	130	\$2907	+\$292
	<b>TL30405E-2BF</b>	43 ⅜"	30"	24"	140	\$3326	+\$334
	left-handed hinged door (illustrated)						
	<b>TR24405E-2BF</b>	43 ⅜"	24"	24"	130	\$2907	+\$292
 <p>Full-length door 9" wide on one side, 27" high hinged door insert, 1-3" pencil and 1-10.5" file drawers on other side. Can be specified with/without mobile file kit.</p>	<b>TL24405E-PF10</b>	43 ⅜"	24"	24"	130	\$2861	+\$288
	<b>TL30405E-PF10</b>	43 ⅜"	30"	24"	140	\$3273	+\$328
	left-handed hinged door (illustrated)						
	<b>TR24405E-PF10</b>	43 ⅜"	24"	24"	130	\$2861	+\$288
 <p>Full-length door 9" wide on one side, 16.5" high hinged door insert, 1-3" pencil and 2-10.5" file drawers on other side. Can be specified with/without mobile file kit.</p>	<b>TL24405E-P2F10</b>	43 ⅜"	24"	24"	130	\$2907	+\$292
	<b>TL30405E-P2F10</b>	43 ⅜"	30"	24"	140	\$3326	+\$334
	left-handed hinged door (illustrated)						
	<b>TR24405E-P2F10</b>	43 ⅜"	24"	24"	130	\$2907	+\$292
 <p>Full-length door 8 ⅜" wide on one side, 24" hinged door insert, 1-3" pencil and 3-10.5" file drawers 13 ⅜" wide on the other.</p>	<b>TL2458E-P3F10</b>	61 ⅜"	24"	24"	185	\$3315	+\$332
	<b>TL3058E-P3F10</b>	61 ⅜"	30"	24"	188	\$3797	+\$382
	left-handed hinged door (illustrated)						
	<b>TR2458E-P3F10</b>	61 ⅜"	24"	24"	185	\$3315	+\$332
	<b>TR3058E-P3F10</b>	61 ⅜"	30"	24"	188	\$3797	+\$382
	right-handed hinged door						

### How to order

1. Specify product number.
2. Specify finish color.
3. Specify options.

### Product code key example

#### TR2458E-3F10

- T** Workplace Tower  
**R** right-handed door  
**24** tower width  
**58** interior height  
**E** 9900 Series  
**3** number of drawers  
**F10** 10 1/2" file drawer

### General information

Exterior cabinet heights are nominal. Actual heights (with glides fully recessed) are 1/8" less. Units containing pencil and/or box drawers include one pencil tray per unit. Each box drawer contains one steel divider. 10 1/2" and 12" drawers have one sliding rail for side-to-side filing of letter size folders or printout binders. Hinged doors are standard with self closing European style hinges and open 110°.

A hinged door insert includes a bottom shelf. This means that the insert door height and usable interior space is actually 1 1/2" less than the heights noted in the descriptions.

### Counterweights

See Counterweight matrix on page 023.

### Lock option

Workplace towers come standard with lock. If lock is not required add suffix 'NL' after product number. Deduct \$50 list per lock.

### Finishes

Refer to Finishes section for color options. Interior drawer bodies and shelves are finished in Eco Black. Bookshelves in side access towers are the same finish as the case.

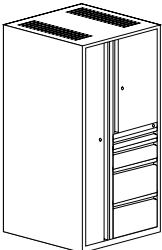
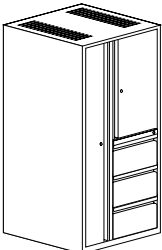
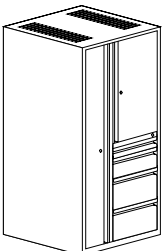
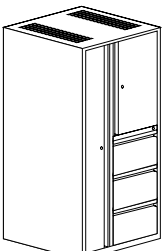
Description	Part number	Exterior height	Width	Depth	Weight (lbs)	Neutral paint/ base price	Accent paint
 <p>Full-length door 8 3/16" wide on one side, 24" hinged door insert 1-3" pencil, 1-7.5" box and 2-12" file drawers 13 5/8" wide on the other.</p>	<b>TL2458E-PB7FF</b>	61 3/8"	24"	24"	185	\$3315	+\$332
	<b>TL3058E-PB7FF</b>	61 3/8"	30"	24"	185	\$3797	+\$382
	<b>TR2458E-PB7FF</b>	61 3/8"	24"	24"	185	\$3315	+\$332
	<b>TR3058E-PB7FF</b>	61 3/8"	30"	24"	185	\$3797	+\$382
 <p>Full-length door 8 3/16" wide on one side, 27" hinged door insert and 3-10.5" file drawers 13 5/8" wide on the other.</p>	<b>TL2458E-3F10</b>	61 3/8"	24"	24"	188	\$3244	+\$326
	<b>TL3058E-3F10</b>	61 3/8"	30"	24"	185	\$3717	+\$373
	<b>TR2458E-3F10</b>	61 3/8"	24"	24"	188	\$3244	+\$326
	<b>TR3058E-3F10</b>	61 3/8"	30"	24"	185	\$3717	+\$373
 <p>Full-length door 8 3/16" wide on one side, 27" hinged door insert 1-3" pencil, 1-7.5" box and 2-10.5" file drawers 13 5/8" wide on the other.</p>	<b>TL2458EPB72F10</b>	61 3/8"	24"	24"	185	\$3315	+\$332
	<b>TL3058EPB72F10</b>	61 3/8"	30"	24"	188	\$3797	+\$382
	<b>TR2458EPB72F10</b>	61 3/8"	24"	24"	185	\$3315	+\$332
	<b>TR3058EPB72F10</b>	61 3/8"	30"	24"	188	\$3797	+\$382
 <p>Full-length door 8 3/16" wide on one side, 24" hinged door insert and 3-12" file drawers 13 5/8" wide on the other.</p>	<b>TL2460E-3F</b>	62 7/8"	24"	24"	185	\$3337	+\$335
	<b>TR2460E-3F</b>	62 7/8"	24"	24"	185	\$3337	+\$335

# Towers

## Workplace Towers and Lockers

Towers

### How to order

1. Specify product number.
2. Specify finish color.
3. Specify options.

### Product code key example

#### TR2458E-PB2F

<b>T</b>	Workplace Tower
<b>R</b>	right-handed door
<b>24</b>	tower width
<b>58</b>	interior height
<b>E</b>	9900 Series
<b>P</b>	pencil drawer
<b>B</b>	6" box drawer
<b>2</b>	number of drawers
<b>F</b>	12" file drawer

### General information

Exterior cabinet heights are nominal. Actual heights (with glides fully recessed) are 1/8" less. Units containing pencil and/or box drawers include one pencil tray per unit. Each box drawer contains one steel divider. 10 1/2" and 12" drawers have one sliding rail for side-to-side filing of letter size folders or printout binders. Hinged doors are standard with self closing European style hinges and open 110°.

A hinged door insert includes a bottom shelf. This means that the insert door height and usable interior space is actually 1 1/2" less than the heights noted in the descriptions.

### Counterweights

See Counterweight matrix on page 023.

### Lock option

Workplace towers come standard with lock. If lock is not required add suffix '/NL' after product number. Deduct \$50 list per lock.

### Finishes

Refer to Finishes section for color options. Interior drawer bodies and shelves are finished in Eco Black. Bookshelves in side access towers are the same finish as the case.

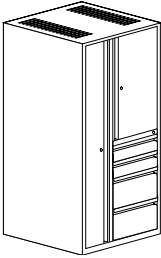
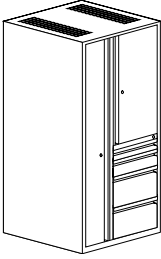
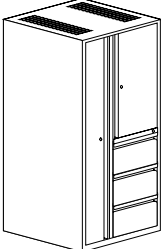
Description	Part number	Exterior height	Width	Depth	Weight (lbs)	Neutral paint/ base price	Accent paint
 <p>Full-length door 8 3/16" wide on one side, 24" hinged door insert, 2-6" box and 2-12" file drawers 13 5/8" wide on the other.</p>	<b>TL2460E-2B2F</b> left-handed hinged door (illustrated)	62 7/8"	24"	24"	185	\$3315	+\$332
	<b>TR2460E-2B2F</b> right-handed hinged door	62 7/8"	24"	24"	185	\$3315	+\$332
 <p>Full-length door 8 3/16" wide on one side, 27" hinged door insert, 1-3" pencil, 1-6" box and 2-12" file drawers 13 5/8" wide on the other.</p>	<b>TL2460E-PB2F</b> left-handed hinged door (illustrated)	62 7/8"	24"	24"	188	\$3315	+\$332
	<b>TR2460E-PB2F</b> right-handed hinged door	62 7/8"	24"	24"	188	\$3315	+\$332
 <p>Full-length door 8 3/16" wide on one side, 27" hinged door insert, 2-10.5" and 1-12" file drawers 13 5/8" wide on the other.</p>	<b>TL2460E-2F10F</b> left-handed hinged door (illustrated)	62 7/8"	24"	24"	185	\$3337	+\$335
	<b>TR2460E-2F10F</b> right-handed hinged door	62 7/8"	24"	24"	185	\$3337	+\$335



### How to order

1. Specify product number.
2. Specify finish color.
3. Specify options.

### Product code key example

#### WL3060E-6HDV

- WL** Workplace locker  
**30** tower width  
**60** interior height  
**E** 9900 Series  
**6** number of openings  
**HD** hinged doors

### General information

Exterior cabinet heights are nominal. Actual heights (with glides fully recessed) are 1/8" less. Hinged doors are standard with self closing European style hinges and open 110°.

A hinged door insert includes a bottom shelf. This means that the insert door height and usable interior space is actually 1 1/2" less than the heights noted in the descriptions.

### Lock option

Cubbi-Stor come standard with lock. If lock is not required add suffix '/NL' after product number. Deduct \$50 list per lock.

**Nuform Cubbi-Stor come with eLocks only.**

### Finishes

Refer to Finishes section for color options. Interior drawer bodies and shelves are finished in Eco Black. Bookshelves in side access towers are the same finish as the case.

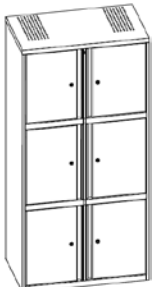
Description	Part number	Exterior height	Width	Depth	Weight (lbs)	Neutral paint/ base price	Accent paint
 <p>Cubbi-Stor with 9900 Front, 1-18" high hinged door over 2-19" high hinged doors on each side. Locks are included</p>	<b>WL3060E-6HDVT</b>	62 7/8"	30"	18"	185	\$2626	+\$267

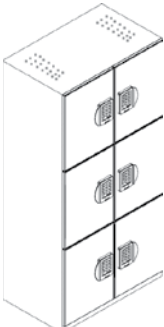
Description	Part number	Exterior height	Width	Depth	Weight (lbs)	Neutral paint/ base price	eLock	Accent paint
 <p>Nuform Cubbi-Stor with eLock 1-18" high hinged doors and 2-19.5" high hinged door on each side</p>	<b>WL3060Q-6HDVT</b>	62 7/8"	30"	18"	200	\$3311	+\$2209	+\$332



# Towers

## Workplace Towers and Lockers Cubbi-Stor

### How to order

1. Specify product number.
2. Specify finish color.
3. Specify options.

### Product code key example

#### VL3058R-6HDV

- V** wardrobe
- L** wardrobe
- 15** cabinet width
- 18** nominal cabinet depth
- 60** interior height
- E** 9900 Series
- 3** number of openings
- HDVT** hinged doors

### General information

Exterior cabinet heights are nominal. Actual heights (with glides fully recessed) are 1/8" less. Hinged doors are standard with self closing European style hinges and open 110°.

A hinged door insert includes a bottom shelf. This means that the insert door height and usable interior space is actually 1 1/2" less than the heights noted in the descriptions.

### Lock option

Cubbi-Stor come standard with lock. If lock is not required add suffix '/NL' after product number. Deduct \$50 list per lock.

**Nuform Cubbi-Stor come with eLocks only. eLocks come in two styles: Dead Bolt style or Slam style**

**There are two eLock types: Multi-use or Single-use**

### Finishes

Refer to Finishes section for color options. Interior drawer bodies and shelves are finished in Eco Black. Bookshelves in side access towers are the same finish as the case.

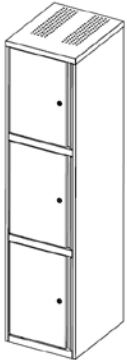
Description	Part number	Exterior height	Width	Depth	Weight (lbs)	Neutral paint/ base price	Accent paint
 <p>Single Cubbi-Stor with 9900 Front, 1-18" high hinged door over 2-19" high hinged doors Locks are included</p>	<b>VL151860EM3HDVT</b> left-handed hinged door (illustrated)	62 7/8"	15"	18"	—	\$1594	+\$163
	<b>VR151860EM3HDVT</b> right-handed hinged door	62 7/8"	15"	18"	—	\$1594	+\$163

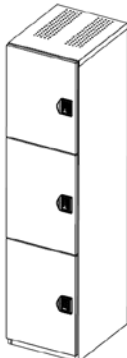
Description	Part number	Exterior height	Width	Depth	Weight (lbs)	Neutral paint/ base price	Accent paint
 <p>Single Nuform Cubbi-Stor, 1-18" high hinged door over 2-19" high hinged doors Locks are included</p>	<b>VL151860Q-3HDVT</b> left-handed hinged door (illustrated)	62 7/8"	15"	18"	—	\$2739	+\$279
	<b>VR151860Q-3HDVT</b> right-handed hinged door	62 7/8"	15"	18"	—	\$2739	+\$279

---

Bookcases  
& display  
cabinets



**Bookcases**

**How to order**

1. Specify product number.
2. Specify finish color.
3. Specify options.

**General information**

Exterior cabinet heights are nominal.  
Actual heights (with glides fully recessed) are 1/8" less. Bookcases are standard with adjustable non-slotted shelves.

**Finishes**

Case interior and shelves match case interior paint color. Refer to Finishes section for color options.

**Product code key example**

**3021-1BK15**

- 30** cabinet width
- 21** interior height
- 1** number of shelves
- BK** bookcase
- 15** cabinet depth

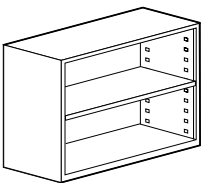
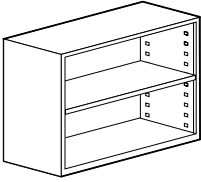
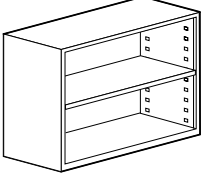
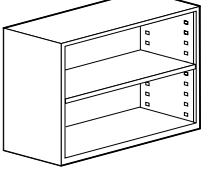
Description	Part number	Exterior height	Width	Depth	Weight (lbs)	Neutral paint/ base price	Accent paint
 <p>2 High Bookcase, 23 7/8" h</p>	<b>1821-1BK15</b>	23 7/8"	18"	15"	50	\$646	+\$65
	<b>2421-1BK15</b>	23 7/8"	24"	15"	50	\$659	+\$66
	<b>3021-1BK15</b>	23 7/8"	30"	15"	50	\$671	+\$68
	<b>3621-1BK15</b>	23 7/8"	36"	15"	50	\$684	+\$70
	<b>4221-1BK15</b>	23 7/8"	42"	15"	50	\$697	+\$72
	<b>1821-1BK18</b>	23 7/8"	18"	18"	50	\$646	+\$65
	<b>2421-1BK18</b>	23 7/8"	24"	18"	50	\$659	+\$66
	<b>3021-1BK18</b>	23 7/8"	30"	18"	50	\$671	+\$68
	<b>3621-1BK18</b>	23 7/8"	36"	18"	50	\$684	+\$70
	<b>4221-1BK18</b>	23 7/8"	42"	18"	50	\$697	+\$72
 <p>2 High Bookcase, 25 3/8" h</p>	<b>1822.5-1BK15</b>	25 3/8"	18"	15"	50	\$657	+\$66
	<b>2422.5-1BK15</b>	25 3/8"	24"	15"	50	\$666	+\$67
	<b>3022.5-1BK15</b>	25 3/8"	30"	15"	50	\$675	+\$68
	<b>3622.5-1BK15</b>	25 3/8"	36"	15"	50	\$685	+\$70
	<b>4222.5-1BK15</b>	25 3/8"	42"	15"	50	\$697	+\$72
	<b>1822.5-1BK18</b>	25 3/8"	18"	18"	50	\$657	+\$66
	<b>2422.5-1BK18</b>	25 3/8"	24"	18"	50	\$666	+\$67
	<b>3022.5-1BK18</b>	25 3/8"	30"	18"	50	\$675	+\$68
	<b>3622.5-1BK18</b>	25 3/8"	36"	18"	50	\$685	+\$70
	<b>4222.5-1BK18</b>	25 3/8"	42"	18"	50	\$697	+\$72
 <p>2 High Bookcase, 26 7/8" h</p>	<b>1824-1BK15</b>	26 7/8"	18"	15"	60	\$652	+\$66
	<b>2424-1BK15</b>	26 7/8"	24"	15"	60	\$662	+\$67
	<b>3024-1BK15</b>	26 7/8"	30"	15"	60	\$671	+\$68
	<b>3624-1BK15</b>	26 7/8"	36"	15"	60	\$678	+\$68
	<b>4224-1BK15</b>	26 7/8"	42"	15"	60	\$690	+\$70
	<b>1824-1BK18</b>	26 7/8"	18"	18"	60	\$652	+\$66
	<b>2424-1BK18</b>	26 7/8"	24"	18"	60	\$662	+\$67
	<b>3024-1BK18</b>	26 7/8"	30"	18"	60	\$671	+\$68
	<b>3624-1BK18</b>	26 7/8"	36"	18"	60	\$678	+\$68
	<b>4224-1BK18</b>	26 7/8"	42"	18"	60	\$690	+\$70
 <p>2 High Bookcase, 29 7/8" h</p>	<b>3027-1BK15</b>	29 7/8"	30"	15"	65	\$678	+\$68
	<b>3627-1BK15</b>	29 7/8"	36"	15"	65	\$713	+\$74
	<b>4227-1BK15</b>	29 7/8"	42"	15"	65	\$726	+\$75
	<b>3027-1BK18</b>	29 7/8"	30"	18"	65	\$678	+\$68
	<b>3627-1BK18</b>	29 7/8"	36"	18"	65	\$713	+\$74
	<b>4227-1BK18</b>	29 7/8"	42"	18"	65	\$726	+\$75

### How to order

1. Specify product number.
2. Specify finish color.
3. Specify options.

### General information

Exterior cabinet heights are nominal.  
Actual heights (with glides fully recessed) are 1/8" less. Bookcases are standard with adjustable non-slotted shelves.

### Finishes

Case interior and shelves match case interior paint color. Refer to Finishes section for color options.

### Product code key example

**3034.5-2BK15**

- 30** cabinet width
- 34.5** interior height
- 2** number of shelves
- BK** bookcase
- 15** cabinet depth

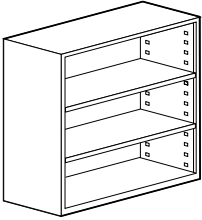
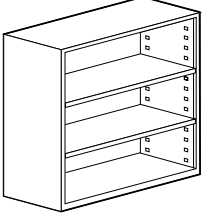
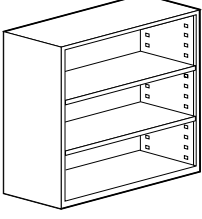
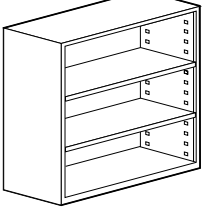
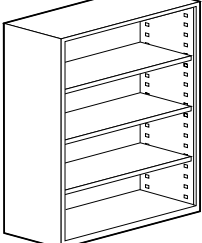
Description	Part number	Exterior height	Width	Depth	Weight (lbs)	Neutral paint/ base price	Accent paint
 <p>3 High Bookcase, 34 3/8" h</p>	<b>3031.5-2BK15</b>	34 3/8"	30"	15"	70	\$759	+\$78
	<b>3631.5-2BK15</b>	34 3/8"	36"	15"	70	\$806	+\$82
	<b>4231.5-2BK15</b>	34 3/8"	42"	15"	70	\$823	+\$84
	<b>3031.5-2BK18</b>	34 3/8"	30"	18"	70	\$759	+\$78
	<b>3631.5-2BK18</b>	34 3/8"	36"	18"	70	\$806	+\$82
	<b>4231.5-2BK18</b>	34 3/8"	42"	18"	70	\$823	+\$84
 <p>3 High Bookcase, 37 3/8" h</p>	<b>3034.5-2BK15</b>	37 3/8"	30"	15"	75	\$949	+\$96
	<b>3634.5-2BK15</b>	37 3/8"	36"	15"	75	\$974	+\$99
	<b>4234.5-2BK15</b>	37 3/8"	42"	15"	75	\$1001	+\$101
	<b>3034.5-2BK18</b>	37 3/8"	30"	18"	75	\$992	+\$100
	<b>3634.5-2BK18</b>	37 3/8"	36"	18"	75	\$1012	+\$102
	<b>4234.5-2BK18</b>	37 3/8"	42"	18"	75	\$1046	+\$106
 <p>3 High Bookcase, 38 7/8" h</p>	<b>3036-2BK15</b>	38 7/8"	30"	15"	80	\$976	+\$99
	<b>3636-2BK15</b>	38 7/8"	36"	15"	80	\$1001	+\$101
	<b>4236-2BK15</b>	38 7/8"	42"	15"	80	\$1027	+\$105
	<b>3036-2BK18</b>	38 7/8"	30"	18"	80	\$1012	+\$102
	<b>3636-2BK18</b>	38 7/8"	36"	18"	80	\$1032	+\$105
	<b>4236-2BK18</b>	38 7/8"	42"	18"	80	\$1067	+\$108
 <p>3 High Bookcase, 40 3/8" h</p>	<b>3037.5-2BK15</b>	40 3/8"	30"	15"	80	\$1018	+\$103
	<b>3637.5-2BK15</b>	40 3/8"	36"	15"	80	\$1039	+\$106
	<b>4237.5-2BK15</b>	40 3/8"	42"	15"	80	\$1060	+\$108
	<b>3037.5-2BK18</b>	40 3/8"	30"	18"	80	\$1050	+\$107
	<b>3637.5-2BK18</b>	40 3/8"	36"	18"	80	\$1066	+\$108
	<b>4237.5-2BK18</b>	40 3/8"	42"	18"	80	\$1096	+\$111
 <p>4 High Bookcase, 44 7/8" h</p>	<b>3042-3BK15</b>	44 7/8"	30"	15"	85	\$1088	+\$110
	<b>3642-3BK15</b>	44 7/8"	36"	15"	85	\$1118	+\$113
	<b>4242-3BK15</b>	44 7/8"	42"	15"	85	\$1132	+\$115
	<b>3042-3BK18</b>	44 7/8"	30"	18"	85	\$1149	+\$116
	<b>3642-3BK18</b>	44 7/8"	36"	18"	85	\$1163	+\$118
	<b>4242-3BK18</b>	44 7/8"	42"	18"	85	\$1171	+\$118

# Bookcases & display cabinets

## Bookcases

### How to order

1. Specify product number.
2. Specify finish color.
3. Specify options.

### General information

Exterior cabinet heights are nominal.  
Actual heights (with glides fully recessed) are  $\frac{1}{8}$ " less. Bookcases are standard with adjustable non-slotted shelves.

### Finishes

Case interior and shelves match case interior paint color. Refer to Finishes section for color options.

### Product code key example

#### 3048-3BK15

- 30** cabinet width  
**48** interior height  
**3** number of shelves  
**BK** bookcase  
**15** cabinet depth

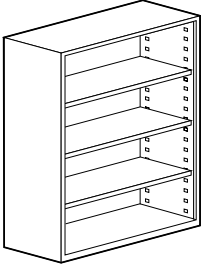
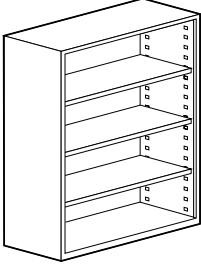
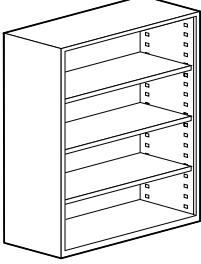
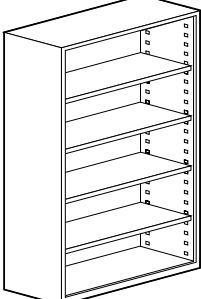
Description	Part number	Exterior height	Width	Depth	Weight (lbs)	Neutral paint/ base price	Accent paint
 4 High Bookcase, 46 $\frac{3}{8}$ " h	<b>3043.5-3BK15</b>	46 $\frac{3}{8}$ "	30"	15"	100	\$1106	+\$112
	<b>3643.5-3BK15</b>	46 $\frac{3}{8}$ "	36"	15"	100	\$1113	+\$113
	<b>4243.5-3BK15</b>	46 $\frac{3}{8}$ "	42"	15"	100	\$1133	+\$115
	<b>3043.5-3BK18</b>	46 $\frac{3}{8}$ "	30"	18"	100	\$1156	+\$117
	<b>3643.5-3BK18</b>	46 $\frac{3}{8}$ "	36"	18"	100	\$1192	+\$120
	<b>4243.5-3BK18</b>	46 $\frac{3}{8}$ "	42"	18"	100	\$1218	+\$123
 4 High Bookcase, 50 $\frac{7}{8}$ " h	<b>3048-3BK15</b>	50 $\frac{7}{8}$ "	30"	15"	100	\$1132	+\$115
	<b>3648-3BK15</b>	50 $\frac{7}{8}$ "	36"	15"	100	\$1146	+\$116
	<b>4248-3BK15</b>	50 $\frac{7}{8}$ "	42"	15"	100	\$1156	+\$117
	<b>3048-3BK18</b>	50 $\frac{7}{8}$ "	30"	18"	100	\$1166	+\$118
	<b>3648-3BK18</b>	50 $\frac{7}{8}$ "	36"	18"	100	\$1195	+\$121
	<b>4248-3BK18</b>	50 $\frac{7}{8}$ "	42"	18"	100	\$1238	+\$125
 4 High Bookcase, 52 $\frac{3}{8}$ " h	<b>3049.5-3BK15</b>	52 $\frac{3}{8}$ "	30"	15"	100	\$1135	+\$115
	<b>3649.5-3BK15</b>	52 $\frac{3}{8}$ "	36"	15"	100	\$1150	+\$116
	<b>4249.5-3BK15</b>	52 $\frac{3}{8}$ "	42"	15"	100	\$1159	+\$117
	<b>3049.5-3BK18</b>	52 $\frac{3}{8}$ "	30"	18"	100	\$1179	+\$119
	<b>3649.5-3BK18</b>	52 $\frac{3}{8}$ "	36"	18"	100	\$1215	+\$123
	<b>4249.5-3BK18</b>	52 $\frac{3}{8}$ "	42"	18"	100	\$1244	+\$125
 4 High Bookcase, 55 $\frac{3}{8}$ " h	<b>3052.5-4BK15</b>	55 $\frac{3}{8}$ "	30"	15"	105	\$1229	+\$124
	<b>3652.5-4BK15</b>	55 $\frac{3}{8}$ "	36"	15"	105	\$1254	+\$126
	<b>4252.5-4BK15</b>	55 $\frac{3}{8}$ "	42"	15"	105	\$1301	+\$131
	<b>3052.5-4BK18</b>	55 $\frac{3}{8}$ "	30"	18"	105	\$1292	+\$130
	<b>3652.5-4BK18</b>	55 $\frac{3}{8}$ "	36"	18"	105	\$1314	+\$132
	<b>4252.5-4BK18</b>	55 $\frac{3}{8}$ "	42"	18"	105	\$1370	+\$137

# Bookcases & display cabinets

## Bookcases

### How to order

1. Specify product number.
2. Specify finish color.
3. Specify options.

### General information

Exterior cabinet heights are nominal.  
Actual heights (with glides fully recessed) are  $\frac{1}{8}$ " less. Bookcases are standard with adjustable non-slotted shelves.

### Finishes

Case interior and shelves match case interior paint color. Refer to Finishes section for color options.

### Product code key example

**3054-4BK15**

**30** cabinet width  
**54** interior height  
**4** number of shelves  
**BK** bookcase  
**15** cabinet depth

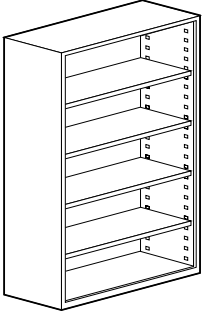
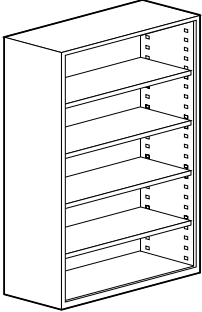
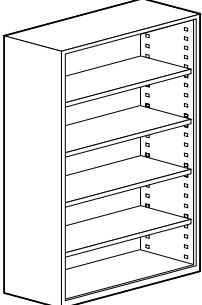
Description	Part number	Exterior height	Width	Depth	Weight (lbs)	Neutral paint/ base price	Accent paint
 5 High Bookcase, 56 $\frac{7}{8}$ " h	<b>3054-4BK15</b>	56 $\frac{7}{8}$ "	30"	15"	105	\$1284	+\$129
	<b>3654-4BK15</b>	56 $\frac{7}{8}$ "	36"	15"	105	\$1307	+\$131
	<b>4254-4BK15</b>	56 $\frac{7}{8}$ "	42"	15"	105	\$1311	+\$132
	<b>3054-4BK18</b>	56 $\frac{7}{8}$ "	30"	18"	105	\$1299	+\$131
	<b>3654-4BK18</b>	56 $\frac{7}{8}$ "	36"	18"	105	\$1337	+\$134
	<b>4254-4BK18</b>	56 $\frac{7}{8}$ "	42"	18"	105	\$1376	+\$139
 5 High Bookcase, 58 $\frac{3}{8}$ " h	<b>3055.5-4BK15</b>	58 $\frac{3}{8}$ "	30"	15"	115	\$1297	+\$130
	<b>3655.5-4BK15</b>	58 $\frac{3}{8}$ "	36"	15"	115	\$1311	+\$132
	<b>4255.5-4BK15</b>	58 $\frac{3}{8}$ "	42"	15"	115	\$1318	+\$132
	<b>3055.5-4BK18</b>	58 $\frac{3}{8}$ "	30"	18"	115	\$1307	+\$131
	<b>3655.5-4BK18</b>	58 $\frac{3}{8}$ "	36"	18"	115	\$1349	+\$135
	<b>4255.5-4BK18</b>	58 $\frac{3}{8}$ "	42"	18"	115	\$1390	+\$140
 5 High Bookcase, 59 $\frac{7}{8}$ " h	<b>3057-4BK15</b>	59 $\frac{7}{8}$ "	30"	15"	115	\$1301	+\$131
	<b>3657-4BK15</b>	59 $\frac{7}{8}$ "	36"	15"	115	\$1314	+\$132
	<b>4257-4BK15</b>	59 $\frac{7}{8}$ "	42"	15"	115	\$1321	+\$133
	<b>3057-4BK18</b>	59 $\frac{7}{8}$ "	30"	18"	115	\$1310	+\$132
	<b>3657-4BK18</b>	59 $\frac{7}{8}$ "	36"	18"	115	\$1354	+\$136
	<b>4257-4BK18</b>	59 $\frac{7}{8}$ "	42"	18"	115	\$1396	+\$142

# Bookcases & display cabinets

## Bookcases

### How to order

1. Specify product number.
2. Specify finish color.
3. Specify options.

### General information

Exterior cabinet heights are nominal.  
Actual heights (with glides fully recessed) are  $\frac{1}{8}$ " less. Bookcases are standard with adjustable non-slotted shelves.

### Finishes

Case interior and shelves match case interior paint color. Refer to Finishes section for color options.

### Product code key example

#### 3060-4BK15

- 30** cabinet width
- 60** interior height
- 4** number of shelves
- BK** bookcase
- 15** cabinet depth

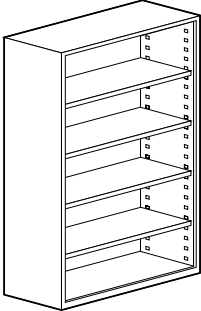
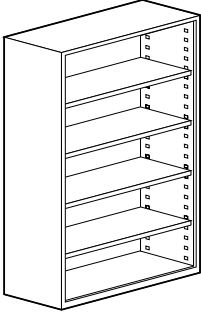
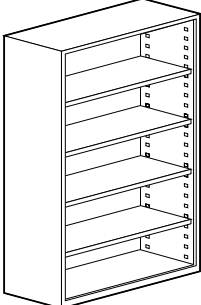
Description	Part number	Exterior height	Width	Depth	Weight (lbs)	Neutral paint/ base price	Accent paint
 5 High Bookcase, 61 $\frac{3}{8}$ " h	<b>3058.5-4BK15</b>	61 $\frac{3}{8}$ "	30"	15"	123	\$1307	+\$131
	<b>3658.5-4BK15</b>	61 $\frac{3}{8}$ "	36"	15"	123	\$1320	+\$133
	<b>4258.5-4BK15</b>	61 $\frac{3}{8}$ "	42"	15"	123	\$1324	+\$133
	<b>3058.5-4BK18</b>	61 $\frac{3}{8}$ "	30"	18"	123	\$1320	+\$133
	<b>3658.5-4BK18</b>	61 $\frac{3}{8}$ "	36"	18"	123	\$1366	+\$137
	<b>4258.5-4BK18</b>	61 $\frac{3}{8}$ "	42"	18"	123	\$1400	+\$142
 5 High Bookcase, 62 $\frac{7}{8}$ " h	<b>3060-4BK15</b>	62 $\frac{7}{8}$ "	30"	15"	130	\$1315	+\$132
	<b>3660-4BK15</b>	62 $\frac{7}{8}$ "	36"	15"	130	\$1329	+\$133
	<b>4260-4BK15</b>	62 $\frac{7}{8}$ "	42"	15"	130	\$1336	+\$134
	<b>3060-4BK18</b>	62 $\frac{7}{8}$ "	30"	18"	130	\$1336	+\$134
	<b>3660-4BK18</b>	62 $\frac{7}{8}$ "	36"	18"	130	\$1350	+\$135
	<b>4260-4BK18</b>	62 $\frac{7}{8}$ "	42"	18"	130	\$1407	+\$143
 5 High Bookcase, 64 $\frac{3}{8}$ " h	<b>3061.5-4BK15</b>	64 $\frac{3}{8}$ "	30"	15"	130	\$1326	+\$133
	<b>3661.5-4BK15</b>	64 $\frac{3}{8}$ "	36"	15"	130	\$1336	+\$134
	<b>4261.5-4BK15</b>	64 $\frac{3}{8}$ "	42"	15"	130	\$1337	+\$134
	<b>3061.5-4BK18</b>	64 $\frac{3}{8}$ "	30"	18"	130	\$1343	+\$135
	<b>3661.5-4BK18</b>	64 $\frac{3}{8}$ "	36"	18"	130	\$1364	+\$137
	<b>4261.5-4BK18</b>	64 $\frac{3}{8}$ "	42"	18"	130	\$1417	+\$144

### How to order

1. Specify product number.
2. Specify finish color.
3. Specify options.

### General information

Exterior cabinet heights are nominal.  
Actual heights (with glides fully recessed) are  $\frac{1}{8}$ " less. Bookcases are standard with adjustable non-slotted shelves.

### Finishes

Case interior and shelves match case interior paint color. Refer to Finishes section for color options.

### Product code key example

**3063-4BK15**

**30** cabinet width  
**63** interior height  
**4** number of shelves  
**BK** bookcase  
**15** cabinet depth

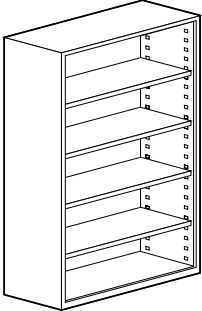
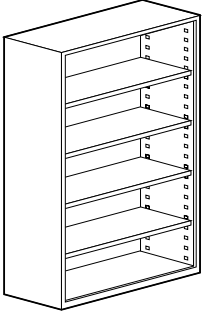
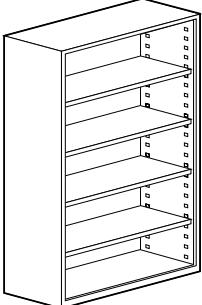
Description	Part number	Exterior height	Width	Depth	Weight (lbs)	Neutral paint/ base price	Accent paint
 <p>5 High Bookcase, 65 <math>\frac{7}{8}</math>" h</p>	<b>3063-4BK15</b>	65 $\frac{7}{8}$ "	30"	15"	130	\$1329	+\$133
	<b>3663-4BK15</b>	65 $\frac{7}{8}$ "	36"	15"	130	\$1338	+\$134
	<b>4263-4BK15</b>	65 $\frac{7}{8}$ "	42"	15"	130	\$1339	+\$134
	<b>3063-4BK18</b>	65 $\frac{7}{8}$ "	30"	18"	130	\$1349	+\$135
	<b>3663-4BK18</b>	65 $\frac{7}{8}$ "	36"	18"	130	\$1364	+\$137
	<b>4263-4BK18</b>	65 $\frac{7}{8}$ "	42"	18"	130	\$1421	+\$144
 <p>5 High Bookcase, 67 <math>\frac{3}{8}</math>" h</p>	<b>3064.5-4BK15</b>	67 $\frac{3}{8}$ "	30"	15"	135	\$1347	+\$135
	<b>3664.5-4BK15</b>	67 $\frac{3}{8}$ "	36"	15"	135	\$1350	+\$135
	<b>4264.5-4BK15</b>	67 $\frac{3}{8}$ "	42"	15"	135	\$1351	+\$136
	<b>3064.5-4BK18</b>	67 $\frac{3}{8}$ "	30"	18"	135	\$1359	+\$136
	<b>3664.5-4BK18</b>	67 $\frac{3}{8}$ "	36"	18"	135	\$1373	+\$139
	<b>4264.5-4BK18</b>	67 $\frac{3}{8}$ "	42"	18"	135	\$1431	+\$145
 <p>5 High Bookcase, 68 <math>\frac{7}{8}</math>" h</p>	<b>3066-4BK15</b>	68 $\frac{7}{8}$ "	30"	15"	135	\$1354	+\$136
	<b>3666-4BK15</b>	68 $\frac{7}{8}$ "	36"	15"	135	\$1360	+\$136
	<b>4266-4BK15</b>	68 $\frac{7}{8}$ "	42"	15"	135	\$1361	+\$137
	<b>3066-4BK18</b>	68 $\frac{7}{8}$ "	30"	18"	135	\$1366	+\$137
	<b>3666-4BK18</b>	68 $\frac{7}{8}$ "	36"	18"	135	\$1378	+\$139
	<b>4266-4BK18</b>	68 $\frac{7}{8}$ "	42"	18"	135	\$1433	+\$145



# Bookcases & display cabinets

## Bookcases

### How to order

1. Specify product number.
2. Specify finish color.
3. Specify options.

### General information

Exterior cabinet heights are nominal.  
Actual heights (with glides fully recessed) are 1/8" less. Bookcases are standard with adjustable non-slotted shelves.



### Finishes

Case interior and shelves match case interior paint color. Refer to Finishes section for color options.

### Product code key example

**30675-4BK15**

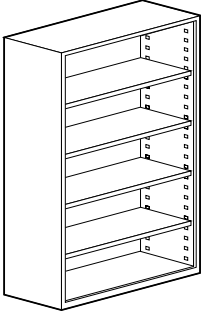
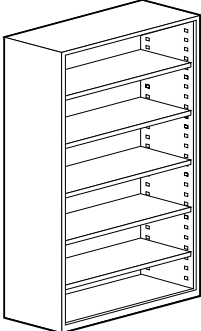
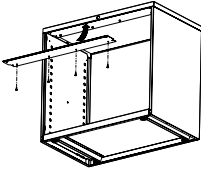
- 30** cabinet width  
**67.5** interior height  
**4** number of shelves  
**BK** bookcase  
**15** cabinet depth

Description	Part number	Exterior height	Width	Depth	Weight (lbs)	Neutral paint/ base price	Accent paint	
 <p>5 High Bookcase, 70 3/8" h</p>	<b>30675-4BK15</b>	70 3/8"	30"	15"	135	\$1362	+\$137	
	<b>36675-4BK15</b>	70 3/8"	36"	15"	135	\$1364	+\$137	
	<b>42675-4BK15</b>	70 3/8"	42"	15"	135	\$1371	+\$139	
	<b>30675-4BK18</b>	70 3/8"	30"	18"	135	\$1376	+\$139	
	<b>36675-4BK18</b>	70 3/8"	36"	18"	135	\$1386	+\$140	
	<b>42675-4BK18</b>	70 3/8"	42"	18"	135	\$1439	+\$146	
	 <p>6 High Bookcase, 70 3/8" h</p>	<b>30675-5BK15</b>	70 3/8"	30"	15"	135	\$1450	+\$146
		<b>36675-5BK15</b>	70 3/8"	36"	15"	135	\$1454	+\$147
		<b>42675-5BK15</b>	70 3/8"	42"	15"	135	\$1463	+\$147
<b>30675-5BK18</b>		70 3/8"	30"	18"	135	\$1463	+\$147	
<b>36675-5BK18</b>		70 3/8"	36"	18"	135	\$1475	+\$149	
<b>42675-5BK18</b>		70 3/8"	42"	18"	135	\$1531	+\$154	
 <p>Bookcase top cover</p>	<b>BKTC-30</b>	—	30"	—	3	\$29	+\$5	
	<b>BKTC-36</b>	—	36"	—	3	\$31	+\$5	
	<b>BKTC-42</b>	—	42"	—	3	\$33	+\$6	
 <p>Adjustable non-slotted shelf</p>	<b>BKSH-3015</b>	1/2"	30"	15"	11	\$88	+\$11	
	<b>BKSH-3615</b>	1/2"	36"	15"	11	\$90	+\$11	
	<b>BKSH-4215</b>	1/2"	42"	15"	11	\$92	+\$11	
	<b>BKSH-3018</b>	1/2"	30"	18"	11	\$88	+\$11	
	<b>BKSH-3618</b>	1/2"	36"	18"	11	\$90	+\$11	
	<b>BKSH-4218</b>	1/2"	42"	18"	11	\$92	+\$11	

# Bookcases & display cabinets

## Display Cabinets

### How to order

1. Specify product number.
2. Specify finish color.
3. Specify options.

### General information

Exterior cabinet heights are nominal.  
Actual heights (with glides fully recessed) are  $\frac{1}{8}$ " less. Bookcases are standard with adjustable non-slotted shelves.

### Finishes

Case interior and shelves match case interior paint color. Refer to Finishes section for color options.

### Product code key example

#### 36-2MS

- 36** cabinet width  
**2** number of shelves  
**MS** display shelf

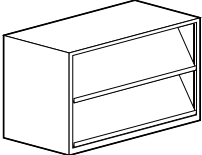
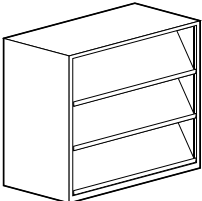
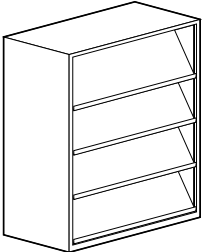
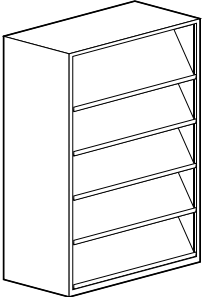
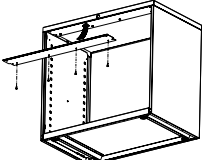
Description	Part number	Exterior height	Width	Depth	Weight (lbs)	Neutral paint/ base price	Accent paint
	<b>30-2MS</b>	26 $\frac{7}{8}$ "	30"	18"	100	\$706	+\$73
	<b>36-2MS</b>	26 $\frac{7}{8}$ "	36"	18"	125	\$747	+\$77
	<b>42-2MS</b>	26 $\frac{7}{8}$ "	42"	18"	135	\$822	+\$84
	<b>36-3MS</b>	38 $\frac{7}{8}$ "	36"	18"	100	\$1012	+\$102
	<b>36-4MS</b>	52 $\frac{3}{8}$ "	36"	18"	130	\$1296	+\$130
	<b>36-5MS</b>	64 $\frac{3}{8}$ "	36"	18"	160	\$1536	+\$155
	<b>BKTC-30</b>	—	30"	—	3	\$29	+\$5
	<b>BKTC-36</b>	—	36"	—	3	\$31	+\$5
	<b>BKTC-42</b>	—	42"	—	3	\$33	+\$6

# Bookcases & display cabinets

## Bookcase Lateral Combinations

### How to order

1. Specify product number.
2. Specify finish color.
3. Specify options.

### Product code key example

**30675-4BK15**



- 30** cabinet width  
**67.5** interior height  
**4** number of shelves  
**BK** bookcase  
**15** cabinet depth

### General information

Exterior cabinet heights are nominal.  
 Actual heights (with glides fully recessed) are  $\frac{1}{8}$ " less. Bookcases are standard with adjustable non-slotted shelves.

### Finishes

Case interior and shelves match case interior paint color. Refer to Finishes section for color options.

Description	Part number	Exterior height	Width	Depth	Weight (lbs)	Neutral paint/ base price	Accent paint
 13.5 bookcase Insert, 10.5" file Flat Glides	<b>30-24-BKF10E</b>	26 $\frac{7}{8}$ "	30"	18"	100	\$981	+\$99
	<b>36-24-BKF10E</b>	26 $\frac{7}{8}$ "	36"	18"	125	\$1051	+\$107
	<b>42-24-BKF10E</b>	26 $\frac{7}{8}$ "	42"	18"	135	\$1142	+\$116
 7.5" box, 16.5" bookcase insert Flat Glides	<b>3024-B7BKE</b>	26 $\frac{7}{8}$ "	30"	18"	98	\$1086	+\$110
	<b>3624-B7BKE</b>	26 $\frac{7}{8}$ "	36"	18"	108	\$1155	+\$117
	<b>4224-B7BKE</b>	26 $\frac{7}{8}$ "	42"	18"	121	\$1245	+\$125

---

# Specialty storage



# Specialty storage

## Verticals

### ANSI/BIFMA

With the addition of counterweights where appropriate, verticals meet all ANSI/BIFMA specifications.

### Construction

Vertical files are of all-welded construction using high quality, tension leveled, cold rolled steel. The steel gauges selected for drawer fronts, bodies and accessories ensure the highest quality durability and performance for all components.

### Construction features & benefits

1. “Wrap-around” construction with no visible vertical seams gives a clean appearance, providing rigid construction and dust-free interiors.
2. Verticals have sound-absorbing materials for quieter operation – a particular asset in open plan environments.
3. Drawer bodies have full-height sides to accommodate hanging file folders, eliminating the need for optional file frames.
4. Drawer sides are slotted on  $\frac{3}{4}$ ” centers to allow for maximum flexibility for drawer division. Compressors are optional. Verticals may be ordered with or without compressors in each drawer.
5. Fully-progressive ball bearing suspensions, are staged so that left and right sides work in unison. This provides smooth drawer operation with minimum force.
6. Staged suspensions allow the drawer to be completely pulled out, providing access to the entire drawer depth.
7. Special “claw-like” device incorporated in the suspension “grips” the fixed section of the suspension arm preventing drawer bounce-back or creep when drawer is closed.

### Safelock™

The patented Safelock mechanism provides complete security against accidental opening of two or more drawers simultaneously. When any drawer is extended, even fractionally, Safelock ensures that all other drawers immediately become inoperable. Safelock is standard on all vertical files.

### Counterweights

Counterweights are required for ALL freestanding units that are not anchored or ganged to other cabinets or bolted to walls/floor.

### Bases

Optional base aprons are available in 2 heights and are screwed to the underside of the file case. Bases may be easily added or changed on site. Vertical files are shipped with bases installed when ordered.

### Glides

Overall heights are inclusive of metal glides. Heights may be increased up to  $\frac{5}{8}$ ” by extending standard glide. Glides are accessible from inside the vertical file when the bottom drawer is removed and may be adjusted with a  $\frac{1}{4}$ ” socket driver.

### Locks

Vertical files come standard with lock. If lock is not required add suffix ‘NL’ after product number. Deduct \$50 list per lock. For lock location, see the guide at the beginning of this price list.

Random keying is standard. Verticals may be ordered keyed alike. Specify. Locks feature removable core and are standard with two keys.

Cabinets originally ordered as non-locking may be field installed with the addition of locking bars and a lock core. Please contact Inscope Client Services for required parts.

Master keys are available at \$45 list. For lock finish options, refer to the front of this price list.

### Finishes

Refer to Finishes section for color options. Drawer bodies and accessories are finished in Eco Black.

### Sizes

Vertical files are 28 $\frac{3}{4}$ ” deep and are available in the following sizes:

No. of Drawers	Letter Width	Legal Width	Exterior Height
2	15”	18”	26 $\frac{7}{8}$ ”
3	15”	18”	38 $\frac{7}{8}$ ”
4	15”	18”	50 $\frac{7}{8}$ ”
5	15”	18”	55 $\frac{3}{8}$ ”

### Drawer Pulls

9900 Series fronts have full width integral pulls with enamel finish to match case fronts.

### How to order

1. Specify product number
2. Specify finish color
3. Specify options

### Product code key example

#### V1828□-4FCP

- V** vertical file
- 18** 18" (legal) width
- 28** 28" nominal depth
- E** 9900 Series
- 4F** number of file drawers
- CP** with compressors

### General information

Exterior cabinet heights are nominal. Actual heights (with glides fully recessed) are 1/8" less. **Vertical depths are nominal. Actual depth for 9900 Series are 3/4" more than noted.** File drawers accept hanging file folders. Bottom tiling is accommodated in cabinets with compressors which are pre-installed in each drawer (suffix **CP**).

### Counterweights

Counterweights are required for ALL freestanding units that are not anchored or ganged to other cabinets or bolted to walls/floor. See Counterweight matrix on 023.

### Accessories

See Vertical File Accessories section for counterweights and accessories.

### Lock option

Verticals come standard with lock. If lock is not required add suffix '**NL**' after product number. Deduct \$50 list.

### Finishes

Refer to Finishes section for color options. Drawer bodies and accessories are finished in Eco Black.

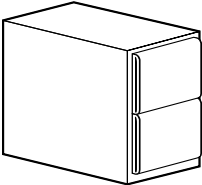
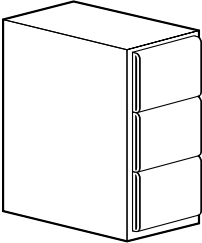
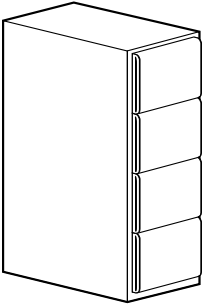
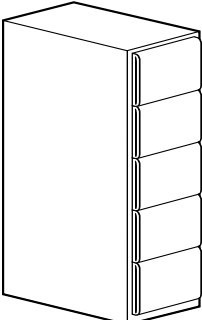
Description	Part number	Exterior height	Width	Case depth	Weight (lbs)	9900 Series/ Neutral paint	Accent paint
	2-12" drawers Letter width	<b>V1528□-2F</b>	26 7/8"	15"	28"	\$856	+\$87
		<b>V1528□-2FCP</b>	26 7/8"	15"	28"	\$885	+\$90
	2-12" drawers Legal width	<b>V1828□-2F</b>	26 7/8"	18"	28"	\$1026	+\$105
		<b>V1828□-2FCP</b>	26 7/8"	18"	28"	\$1059	+\$108
	3-12" drawers Letter width	<b>V1528□-3F</b>	38 7/8"	15"	28"	\$1027	+\$105
		<b>V1528□-3FCP</b>	38 7/8"	15"	28"	\$1073	+\$109
	3-12" drawers Legal width	<b>V1828□-3F</b>	38 7/8"	18"	28"	\$1083	+\$110
		<b>V1828□-3FCP</b>	38 7/8"	18"	28"	\$1128	+\$114
	4-12" drawers Letter width	<b>V1528□-4F</b>	50 7/8"	15"	28"	\$1285	+\$129
		<b>V1528□-4FCP</b>	50 7/8"	15"	28"	\$1344	+\$135
	4-12" drawers Legal width	<b>V1828□-4F</b>	50 7/8"	18"	28"	\$1309	+\$132
		<b>V1828□-4FCP</b>	50 7/8"	18"	28"	\$1369	+\$137
	5-10.5" drawers Letter width	<b>V1528□-5F</b>	55 3/8"	15"	28"	\$1521	+\$154
		<b>V1528□-5FCP</b>	55 3/8"	15"	28"	\$1594	+\$161
	5-10.5" drawers Legal width	<b>V1828□-5F</b>	55 3/8"	18"	28"	\$1550	+\$157
		<b>V1828□-5FCP</b>	55 3/8"	18"	28"	\$1620	+\$163

# Specialty Storage

## Waste & Recycle Bins

### How to order

1. Specify product number
2. Specify finish color
3. Specify options

### Product code key example

#### V1518EM-F24R

- V** vertical file
- 15** width
- 18** depth
- EM** 9900 series front
- F** Fixed front
- 24** interior dimension
- R** recycling unit

### General information

Exterior cabinet heights are nominal. Actual heights (with glides fully recessed) are  $\frac{1}{8}$ " less. **Vertical depths are nominal. Actual depth for 9900 Series are  $\frac{3}{4}$ " more.**

### Counterweights

Counterweights **MUST** be specified separately if the Waste & Recycling Bins are used in a freestanding application. See Counterweight matrix on 022. Add \$129 for a counterweight.

### Accessories



See Vertical File Accessories section for counterweights and accessories. Clear plastic label holders are available at no charge.

### Lock option

A lock is not included with these cabinets.

### Finishes

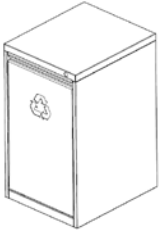
Available in all standard paint colours. Refer to Finishes section for colour options. A contrasting colour may be selected for the drawer front liner behind the pullout front symbole. Drawer bodies and accessories are finished in Eco Black.

Description	Part number	Height	Width	Case depth	Weight (lbs)	Neutral paint/ base price	Accent paint
 <p>9900 Series Vertical File with Pullout Recycle Drawer Bin included Worksurface supporting</p>	<b>V1518EM-F24R</b>	26 $\frac{7}{8}$ "	15"	18"	—	\$828	+\$96
 <p>9900 Series Vertical File with Pullout Recycle Drawer and 4.5" Box Drawer Above Bin included</p>	<b>V1518EMB4F24TBR</b>	32 $\frac{7}{8}$ "	15"	18"	—	\$1069	+\$124
 <p>Recycle Bin Replacment</p>	<b>RECYCLEBIN</b>	19 $\frac{7}{8}$ "	11"	15 $\frac{1}{4}$ "	—	\$39	—

### How to order

1. Specify product number
2. Specify finish color
3. Specify options

### Product code key example

#### V1518EM-F24W

- V** vertical file
- 15** width
- 18** depth
- EM** 9900 series front
- F** Fixed front
- 24** interior dimension
- W** waste unit

### General information

Exterior cabinet heights are nominal. Actual heights (with glides fully recessed) are 1/8" less. **Vertical depths are nominal. Actual depth for 9900 Series are 3/4" more.**

### Counterweights

Counterweights **MUST** be specified if the Waste & Recycling Bins are used in a freestanding application. See Counterweight matrix on 022. Add \$129 for a counterweight.

### Accessories



See Vertical File Accessories section for counterweights and accessories. Clear plastic label holders are available at no charge.

### Lock option

A lock is not included with these cabinets.

### Finishes

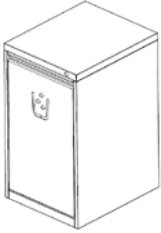
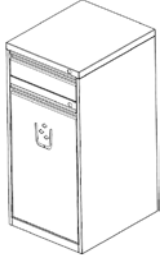
Available in all standard paint colours. Refer to Finishes section for colour options. A contrasting colour may be selected for the drawer front liner behind the pullout front symbole. Drawer bodies and accessories are finished in Eco Black.

Description	Part number	Height	Width	Case depth	Weight (lbs)	Neutral paint/ base price	Accent paint
 <p>9900 Series Vertical File with Pullout Waste Drawer Bin included Worksurface supporting</p>	<b>V1518EM-F24W</b>	26 7/8"	15"	18"	—	\$811	+\$95
 <p>9900 Series Vertical File with Pullout Waste Drawer and 4.5" Box Drawer Above Bin included</p>	<b>V1518EMB4F24TBW</b>	32 7/8"	—	18"	—	\$1052	+\$122
 <p>Waste Bin Replacment</p>	<b>WASTEBIN</b>	19 7/8"	11"	15 1/4"	—	\$28	—



# Specialty Storage

## Fusion

### How to order

1. Specify product number
2. Specify finish color
3. Specify options

### Product code key example

#### 3018E-LHBKBFM

- 30** width
- 18** depth
- E** 9900 series front
- LH** left hand
- BK** bookcase
- B** 6" box drawer
- F** 12" file drawer
- M** mobile

### Counterweights

Counterweight is included.

### Castors

These cabinets will include two swivel casters with a brake and two swivel casters without brake.

### Lock option

Locking is standard.

In the units with pedestals configurations, the lock is 2" off center towards the drawers

For the unit with the hinged door, the lock is in the door.



Non-locking is not an available option for these units.

### Finishes

Available in all standard paint colours.

Refer to Finishes section for colour options.

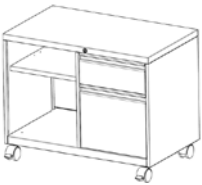
Drawer bodies and accessories are finished in Eco Black.

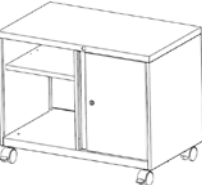
Description	Part number	Height	Width	Case depth	Neutral paint/ base price	Accent paint
 <p>Fusion 9900 Series Mobile Storage &amp; Bookcase Combo unit with 15" w open bookcase on one side and 15" w x 6" box over 12" file drawers on the other</p>	<b>3018E-LHBKBFM</b> left-hand bookcase (illustrated)	23 ¾"	30"	18"	\$1073	+\$109
	<b>3018E-RHBKBFM</b> right-hand bookcase	23 ¾"	30"	18"	\$1073	+\$109
<p>Fusion 9900 Series Mobile Storage &amp; Bookcase Combo unit with 21" w open bookcase on one side and 15" w x 6" box over 12" file drawers on the other</p>	<b>3618E-LHBKBFM</b> left-hand bookcase	23 ¾"	36"	18"	\$1084	+\$110
	<b>3618E-RHBKBFM</b> right-hand bookcase	23 ¾"	36"	18"	\$1084	+\$110
 <p>Fusion 9900 Series Mobile Storage &amp; Bookcase Combo unit with 15" w open bookcase on one side and 3 - 15" w x 6" box drawers on the other</p> <p>+\$110</p>	<b>3018E-LHBK3BM</b> left-hand bookcase (illustrated)	23 ¾"	30"	18"	\$1220	+\$123
	<b>3018E-RHBK3BM</b> right-hand bookcase	23 ¾"	30"	18"	\$1220	+\$123
	<b>3618E-LHBK3BM</b> left-hand bookcase	23 ¾"	36"	18"	\$1231	+\$124
	<b>3618E-RHBK3BM</b> right-hand bookcase	23 ¾"	36"	18"	\$1231	+\$124
 <p>Fusion 9900 Series Mobile Storage &amp; Bookcase Combo unit with 15" w open bookcase on one side and 15" w hinged door on the other</p> <p>+\$110</p>	<b>3018E-LHBKHDM</b> left-hand bookcase (illustrated)	23 ¾"	30"	18"	\$1163	+\$117
	<b>3018E-RHBKHDM</b> right-hand bookcase	23 ¾"	30"	18"	\$1163	+\$117
	<b>3618E-LHBKHDM</b> left-hand bookcase	23 ¾"	36"	18"	\$1175	+\$118
	<b>3618E-RHBKHDM</b> right-hand bookcase	23 ¾"	36"	18"	\$1175	+\$118

---

# Storage with Handles



# Storage with Handles

## Pedestals

### ANSI/BIFMA

With the addition of counterweights where appropriate, pedestal meet all ANSI/BIFMA specifications.

### Construction

Pedestals are welded, “wrap-around” construction using 20 and 22 gauge high quality, tension leveled, cold rolled steel. The steel gauges selected for drawer fronts, bodies and accessories ensure the highest quality durability and performance for all components.

### Construction Features & Benefits

1. Completely enclosed case provides rigid construction and dust-free interiors.
2. Box drawer sides are slotted on 1” centers to allow for maximum flexibility for drawer division.
3. File (10½” and 12”) drawer bodies have full height sides to accommodate hanging file folders, eliminating the need for optional file frames.
4. Fully-progressive ball bearing suspensions on all drawers, including pencil and box drawers, are staged so that left and right sides work in unison. This provides smooth drawer operation with minimum force.
5. Staged suspensions allow the drawer to be completely pulled out, providing access to the entire drawer depth.
6. Special “claw-like” device incorporated in the suspension “grips” the fixed section of the suspension arm preventing drawer bounce-back or creep when drawer is closed.
7. Casters and glides are both recessed “inboard” for a uniform exterior appearance with no visible hardware.
8. Modular interior allows for complete interchangeability of drawer types within the pedestal case. For example, two 6” box drawers may be replaced by one 12” file drawer.
9. 18” deep pedestals come standard with 18” deep drawers. 22” and 28” deep pedestals come standard with 22” deep drawers.

### Counterweights

Counterweights are required for ALL freestanding units that are not anchored or ganged to other cabinets or bolted to walls/floor.

Counterweights come standard with ALL mobile pedestals and must be field installed.

### Drawer Standard Equipment

15” letter width storage drawers: 3” pencil drawer, 6” box drawer, 10½” and 12” file drawer are standard.

Pedestals containing 3” or 6” drawers are provided with one pencil tray per pedestal. 6” drawers are additionally standard with one steel divider.

**Hangfile bars are not included with Pedestals with Handles. Refer to accessories section for codes and pricing.**

### Bases

Optional base aprons are available in 2 standard heights and are screwed to the underside of the pedestal case. Bases may be easily added or changed on site. Pedestals are shipped with bases installed when ordered.

### Castors

Four swivel, recessed 1⅝” black, double-wheel phenolic carpet casters are supplied with mobile pedestals and must be field installed.

### Glides

Overall heights are inclusive of metal glides. Heights may be increased up to ⅝” by extending standard glide. Glides are accessible from inside the pedestal when the bottom drawer is fully extended or removed and may be adjusted with a ¼” socket driver.

Optional 1½” stem glides are available. Specify separately and add \$26 list to the pedestal price. Requires field installation.

### Locks

Pedestals come standard with lock. If lock is not required add suffix ‘/NL’ after product number. Deduct \$50 list per lock. For lock location, see the front of this price list. Mobile pedestals must include locks.

Random keying is standard. Pedestals may be ordered keyed alike. Specify. Locks feature removable core and are standard with two keys, one of which has a black neoprene plastic key cover.

Cabinets originally ordered as non-locking may be field installed with the addition of locking bars and a lock core. Please contact Inscape Client Services for required parts.





Master keys are available at \$45 list.

### Finishes

Refer to Finishes section for color options. For lock finish options, refer to the front of this price list.

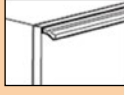
### Drawer Pulls

Storage with Handles have 6 styles options. FP002 is the default pull.

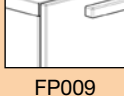
Pull	Storage with Handles	Nuform	Veneer
 FP001 P290 Aluminum Leaf Finish			
 FP002 Matte Chrome Finish			
 FP004 Brushed Nickel Finish			
 FP005 Satin Nickel Finish			
 FP007 Brushed Nickel Finish	+\$73	+\$73	+\$73
 FP008 Matte Chrome Finish	+\$73	+\$73	+\$73
 FP009 Nickel Plated Matte Finish	+\$73	+\$73	+\$73

Available      Unavailable

Pulls FP004, FP005, FP007 and FP008 meet the guidelines for ADA compliance.

**Note: FP002 is not available on hinged door cabinets.**

### How to order

1. Specify product number.
2. Specify finish color.
3. Specify options.

### Product code key example

#### 1518H-2BF10

- 15** -pedestal width
- 18** -pedestal depth
- H** -Storage with Handles
- 2** -number of drawers
- B** -6" box
- F10** -10 1/2" file drawer

### General information

Pedestals are standard with either glides or casters. Exterior pedestal heights are nominal. Pedestals with 3" or 6" drawers are standard with one pencil tray per pedestal and one steel divider per 6" drawer. Hang file bars for file drawers must be ordered separately.

### Counterweights

Counterweights are required for ALL freestanding units that are not anchored or ganged to other cabinets or bolted to walls/floor. Counterweights are standard with all mobile pedestals and must be field installed. See Counterweight matrix on 23.

### Accessories



See Pedestal Accessories section for accessories.

### Lock option

Pedestals come standard with lock. If lock is not required add suffix '/NL' after product number. Deduct \$50 list.

### Finishes

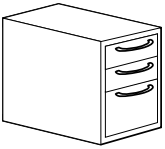
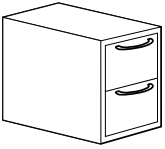
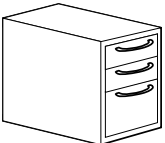
Refer to finishes section for color options. Drawer bodies and accessories are finished in Eco Black.

Description	Part number	Height	Depth	Weight (lbs)	Neutral paint/ base price	Accent paint
	2 box, 1-10.5" file glides	<b>1518H-2BF10</b> 25 3/8"	18"	90	\$812	+\$83
		<b>1522H-2BF10</b> 25 3/8"	22"	90	\$919	+\$93
		<b>1528H-2BF10</b> 25 3/8"	28"	100	\$967	+\$98
	2 box, 1-10.5" file, mobile, counterweights are included	<b>1518H-2BF10M</b> 26"	18"	85	\$978	+\$99
		<b>1522H-2BF10M</b> 26"	22"	95	\$1084	+\$110
	Mobile pedestals must be locking	<b>1528H-2BF10M</b> 26"	28"	100	\$1132	+\$115
	1-10.5" file, 1-12" file glides	<b>1518H-F10F</b> 25 3/8"	18"	80	\$746	+\$77
		<b>1522H-F10F</b> 25 3/8"	22"	90	\$807	+\$83
		<b>1528H-F10F</b> 25 3/8"	28"	100	\$833	+\$85
	1-10.5" file, 1-12" file, mobile, counterweights are included	<b>1518H-F10FM</b> 26"	18"	85	\$914	+\$93
		<b>1522H-F10FM</b> 26"	22"	95	\$978	+\$99
	Mobile pedestals must be locking	<b>1528H-F10FM</b> 26"	28"	100	\$1004	+\$101
	2 box, 1-12" file glides	<b>1518H-2BF</b> 26 7/8"	18"	80	\$812	+\$83
		<b>1522H-2BF</b> 26 7/8"	22"	90	\$919	+\$93
		<b>1528H-2BF</b> 26 7/8"	28"	100	\$967	+\$98

# Storage with Handles

## Pedestals

### Cushion Pedestals

#### How to order

1. Specify product number.
2. Specify finish color.
3. Specify options.

#### Product code key example

**1518H-B7F10MCNH**

- 15** pedestal width  
**18** pedestal depth  
**H** Storage with Handles  
**B7** 7½" box  
**F10** 10 ½" file drawer  
**M** mobile  
**C** cushion  
**NH** no handle

#### General information

Cushion Mobile pedestals are topped with a 1¼" thick CAL 117 fire-retardant polyurethane foam with a 2.2 lb/ft. density. This upholstered cushion is balanced with a 7/16" board and is attached to the pedestal top with Velcro.

For application of ALL fabrics, both from our graded program as well as COM (customers own material), please specify layout orientation at time of order. If layout instructions are not provided we will choose the direction to maximize our production. Refer to page 15 for additional layout and COM details.

#### Counterweights

Counterweights are standard with all mobile pedestals and must be field installed. See Counterweight matrix on page 023.

#### Accessories

See Pedestal Accessories section for accessories.

#### Finishes

Refer to finishes section for color options. Drawer bodies and accessories are finished in Eco Black.

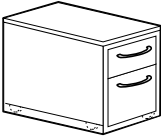
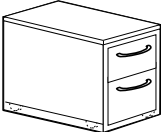
Description	Part number	Height	Depth	Weight (lbs)	Neutral paint/ base price (grade A fabric)	Accent paint
 <p>Cushion pedestal 1-6" box, 1-12" file drawer, mobile, without handle, counterweights are included Mobile pedestals must be locking</p>	<b>1518H-BFMCNH</b>	22 ½"	18"	93	\$1009	+\$102
	<b>1522H-BFMCNH</b>	22 ½"	22"	105	\$1046	+\$106
	<b>1528H-BFMCNH</b>	22 ½"	28"	117	\$1089	+\$111
 <p>Cushion pedestal 1-7½" box, 1-10.5" file drawer, mobile, without handle, counterweights are included Mobile pedestals must be locking</p>	<b>1518H-B7F10MCNH</b>	22 ½"	18"	93	\$978	+\$99
	<b>1522H-B7F10MCNH</b>	22 ½"	22"	105	\$1089	+\$111
	<b>1528H-B7F10MCNH</b>	22 ½"	28"	117	\$1132	+\$115

#### Fabric upcharge for mobile cushion pedestals

**Note: To price fabric grade options add the upcharge (+\$) in the chart below to the base price of the List price (Grade A) column. This will be the total cost for that product.**

Grade B/COM	Grade C	Grade D	Grade E	Grade F
+\$50	+\$92	+\$130	+\$156	+\$223

### ANSI/BIFMA

With the addition of counterweights where appropriate, lateral files meet all ANSI/BIFMA specifications.

### Construction

Lateral files and hinged door cabinets are of all-welded construction using 20 and 22 gauge high quality, tension leveled, cold rolled steel. The steel gauges selected for drawer fronts, bodies and accessories ensure the highest quality durability and performance for all components.

### Construction features & benefits

1. All interiors are modular and interchangeable so that cabinets can be retrofitted with new accessories and interiors as required.
2. Lift-up door carrier mechanism has four nylon rollers, two on each side, for smooth receding action with no binding or snagging.
3. Front leading edge of pullout shelves is beaded and rolled to provide grip for pullout action and to strengthen shelf; front leading edge of fixed shelf is flat for easy removal of material.
4. Fully-progressive ball bearing suspensions are staged so that left and right sides work in unison. This provides smooth drawer operation with minimum force.
5. Special "claw-like" device incorporated in suspensions "grips" the fixed section of the suspension arm preventing drawer bounce-back or creep when drawer is closed.
6. Lock bars operate vertically on both sides of the cabinet for maximum security.
7. Lock fingers are configured with right angle bend upward, not downward, so that lift-up doors cannot be pulled down to disengage fingers from door slots and be forced to circumvent lock system.
8. Plastic buttons in side gables of case where top sections of lift-up doors recede into the cabinet eliminate metal-to-metal contact.
9. Plastic buttons in the ends of each drawer and door front eliminates metal-to-metal contact between cabinet sides and closed drawers.
10. Self-closing, 110° opening, European style cupboard hinges provide smooth hinged door operation. Hinges are not visible from the exterior of the cabinet

### Counterweights

Counterweights are required for ALL freestanding units that are not anchored or ganged to other cabinets or bolted to walls/floor.

### Safelock™

The patented Safelock mechanism provides complete security against accidental opening of two or more drawers simultaneously. When any drawer or single pullout shelf is extended, even fractionally, Safelock ensures that all other openings, except for the 3" and 4½" drawers, immediately become inoperable. Safelock is standard on all lateral files. The only exceptions are the 3" and 4½" drawers and the upper shelf in a two pullout shelf opening.

### Drawer standard equipment

Pullout drawers are standard with one pair hangfile bars for side-to-side suspended filing. Optional accessories are available.

### Bases

Optional base aprons are available in 2 heights and are screwed to the underside of the cabinet. Bases may be easily added or changed on site. Cabinets are shipped with bases installed when ordered.

### Glides

Overall heights are inclusive of metal glides. Heights may be increased up to ⅝" by extending standard glide. Glides are accessible from inside the cabinet when the bottom drawer is fully extended or removed and may be adjusted with a ¼" socket driver.

Optional 1½" stem glides are available. Specify separately and add \$26 list to the cabinet price. Requires field installation.

### Locks

Cabinets come standard with lock. If lock is not required add suffix '/NL' after product number. Deduct \$50 list per lock. For lock location, see the guide at the beginning of this price list.

Random keying is standard. Files may be ordered keyed alike. Specify. Locks feature removable core and are standard with two keys, one of which has a black neoprene plastic key cover.

Cabinets originally ordered as non-locking may be field installed with the addition of locking bars and a lock core. Please contact Inscape Client Services for required parts.

Master keys are available at \$45 list.

### Lateral file tops





Refer to Accessories section to order Laminate, Nuform and Veneer tops.

### Finishes

Refer to Finishes section for color options. For lock finish options, refer to the front of this price list.

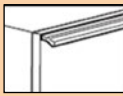
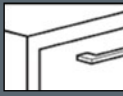
### Drawer Pulls

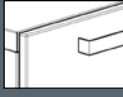
Storage with Handles have 6 styles options. FP002 is the default pull.

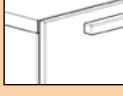
Pull	Storage with Handles	Nuform	Veneer
 FP001 P290 Aluminum Leaf Finish			
 FP002 Matte Chrome Finish			
 FP004 Brushed Nickel Finish			
 FP005 Satin Nickel Finish			
 FP007 Brushed Nickel Finish	+\$73	+\$73	+\$73
 FP008 Matte Chrome Finish	+\$73	+\$73	+\$73
 FP009 Nickel Plated Matte Finish	+\$73	+\$73	+\$73

Available      Unavailable

Pulls FP004, FP005, FP007 and FP008 meet the guidelines for ADA compliance.

**Note: FP002 is not available on hinged door cabinets.**

# Storage with Handles

## Laterals

### How to order

1. Specify product number.
2. Specify finish color.
3. Specify options.

### Product code key example

#### 30-24-P2FFH

- 30** cabinet width  
**24** interior height  
**P** pencil drawer  
**2** number of file drawers  
**FF** fixed front  
**H** Storage with Handles

### General information

Exterior cabinet heights are nominal. Actual heights (with glides fully recessed) are  $\frac{1}{8}$ " less. Hinged doors are standard with self-closing European style hinges that open 110°. Shelves are slotted every 1½" and are height adjustable in 1½" increments.

**Cabinets are 18" in depth.**

### Counterweights

Counterweights are required for ALL freestanding units that are not anchored or ganged to other cabinets or bolted to walls/floor. See Counterweight matrix on page 023.

### Accessories



See Lateral File Accessories section for counterweights and accessories.

### Lock option

Cabinets come standard with lock. If lock is not required add suffix '**/NL**' after product number. Deduct \$50 list.

### Finishes

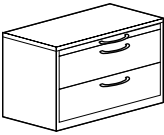
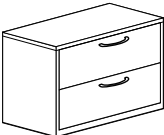
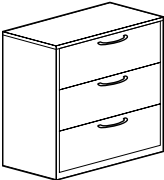
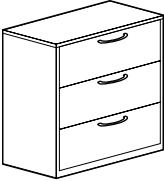
Refer to finishes section for color options. Drawer bodies and accessories are finished in Eco Black.

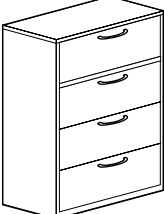
Description	Part number	Height	Depth	Weight (lbs)	Neutral paint/ base price	Accent paint
 <p><b>2 high cabinet</b>  <b>top opening 3" drawer, other</b>  <b>2 openings 10.5" fixed front</b>  <b>drawers</b>  <b>Counterweight is recommended</b></p>	<b>30-24-P2FFH</b>	26 $\frac{7}{8}$ "	30"	100	\$1163	+\$118
	<b>36-24-P2FFH</b>	26 $\frac{7}{8}$ "	36"	120	\$1270	+\$128
	<b>42-24-P2FFH</b>	26 $\frac{7}{8}$ "	42"	130	\$1377	+\$139
 <p><b>2 high cabinet</b>  <b>2-12" fixed front drawers</b>  <b>Counterweight is recommended</b></p>	<b>30-2FFH</b>	26 $\frac{7}{8}$ "	30"	100	\$972	+\$98
	<b>36-2FFH</b>	26 $\frac{7}{8}$ "	36"	120	\$1067	+\$108
	<b>42-2FFH</b>	26 $\frac{7}{8}$ "	42"	130	\$1169	+\$118
 <p><b>3 high cabinet</b>  <b>3-10.5 fixed front drawers</b></p>	<b>30-31.5-3FFH</b>	34 $\frac{3}{8}$ "	30"	120	\$1302	+\$131
	<b>36-31.5-3FFH</b>	34 $\frac{3}{8}$ "	36"	140	\$1435	+\$146
	<b>42-31.5-3FFH</b>	34 $\frac{3}{8}$ "	42"	160	\$1607	+\$162
 <p><b>3 high cabinet</b>  <b>3-12" fixed front drawers</b></p>	<b>30-3FFH</b>	38 $\frac{7}{8}$ "	30"	130	\$1308	+\$131
	<b>36-3FFH</b>	38 $\frac{7}{8}$ "	36"	150	\$1447	+\$147
	<b>42-3FFH</b>	38 $\frac{7}{8}$ "	42"	170	\$1628	+\$164
 <p><b>4 high cabinet</b>  <b>4-10.5" fixed front drawers</b></p>	<b>30-42-4FFH</b>	44 $\frac{7}{8}$ "	30"	140	\$1607	+\$162
	<b>36-42-4FFH</b>	44 $\frac{7}{8}$ "	36"	160	\$1831	+\$184
	<b>42-42-4FFH</b>	44 $\frac{7}{8}$ "	42"	180	\$2075	+\$209
 <p><b>4 high cabinet</b>  <b>4-12" fixed front</b>  <b>drawers, 1.5" tie bar</b></p>	<b>30-4FFH</b>	52 $\frac{3}{8}$ "	30"	170	\$1623	+\$164
	<b>36-4FFH</b>	52 $\frac{3}{8}$ "	36"	195	\$1873	+\$189
	<b>42-4FFH</b>	52 $\frac{3}{8}$ "	42"	230	\$2133	+\$215

### How to order

1. Specify product number.
2. Specify finish color.
3. Specify options.

### Product code key example

#### 30-52.5-5FFH

- 30** cabinet width  
**52.5** interior height  
**5** number of drawers  
**FF** fixed front  
**H** Storage with Handles

### General information

Exterior cabinet heights are nominal. Actual heights (with glides fully recessed) are  $\frac{1}{8}$ " less. Hinged doors are standard with self-closing European style hinges that open 110°. Shelves are slotted every 1½" and are height adjustable in 1½" increments.

**Cabinets are 18" in depth.**

### Counterweights

Counterweights are required for ALL freestanding units that are not anchored or ganged to other cabinets or bolted to walls/floor. See Counterweight matrix on page 023.

### Accessories

See Lateral File Accessories section for counterweights and accessories.

### Lock option

Cabinets come standard with lock. If lock is not required add suffix **'/NL'** after product number. Deduct \$50 list.

### Finishes

Refer to finishes section for color options. Drawer bodies and accessories are finished in Eco Black.

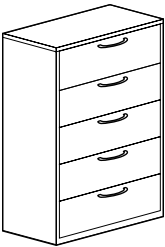
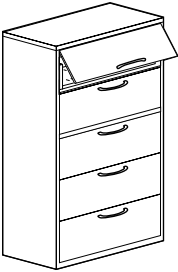
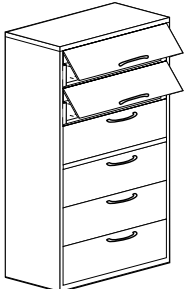
Description	Part number	Height	Depth	Weight (lbs)	Neutral paint/ base price	Accent paint	
	<b>5 high cabinet</b>	<b>30-52.5-5FFH</b>	55 $\frac{3}{8}$ "	30"	180	\$1913	+\$192
	<b>5-10.5" fixed front drawers</b>	<b>36-52.5-5FFH</b>	55 $\frac{3}{8}$ "	36"	205	\$2187	+\$221
		<b>42-52.5-5FFH</b>	55 $\frac{3}{8}$ "	42"	240	\$2489	+\$250
	<b>5 high cabinet</b>	<b>30-5FFH</b>	64 $\frac{3}{8}$ "	30"	200	\$1933	+\$194
	<b>top opening 12" lift-up with</b>	<b>36-5FFH</b>	64 $\frac{3}{8}$ "	36"	235	\$2211	+\$223
	<b>pullout shelf, other 4 openings</b>	<b>42-5FFH</b>	64 $\frac{3}{8}$ "	42"	265	\$2514	+\$253
	<b>12" fixed front drawers, 1.5" tie bar</b>						
	<b>6 high cabinet</b>	<b>30-6FFH</b>	76 $\frac{3}{8}$ "	30"	250	\$2354	+\$237
	<b>top opening 12" lift-up with fixed</b>	<b>36-6FFH</b>	76 $\frac{3}{8}$ "	36"	270	\$2691	+\$270
	<b>shelf and 3 plate dividers, next</b>	<b>42-6FFH</b>	76 $\frac{3}{8}$ "	42"	291	\$3033	+\$304
	<b>opening 12" lift-up with pullout</b>						
	<b>shelf and hangfile bars, other 4</b>						
	<b>openings 12" fixed front drawers,</b>						
	<b>1.5" tie bar</b>						



# Storage with Handles

## Laterals

Overfile and Storage Cabinets

### How to order

1. Specify product number.
2. Specify finish color.
3. Specify options.

### Product code key example

**3036HDH-SH**

- 30** cabinet width  
**36** interior height  
**HD** hinged door  
**H** Storage with Handles  
**SH** shelf

### General information

Exterior cabinet heights are nominal. Actual heights (with glides fully recessed) are  $\frac{1}{8}$ " less. Hinged doors are standard with self-closing European style hinges that open 110°. Shelves are slotted every 1½" and are height adjustable in 1½" increments.

**Cabinets are 18" in depth.**

### Accessories



See Lateral File Accessories section for counterweights and accessories.

### Lock option

Cabinets come standard with lock. If lock is not required add suffix '**/NL**' after product number. Deduct \$50 list.

### Finishes

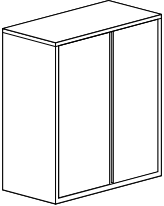
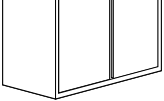
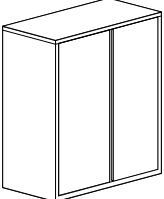
Refer to finishes section for color options. Drawer bodies and accessories are finished in Eco Black.

Description	Part number	Height	Depth	Weight (lbs)	Neutral paint/ base price	Accent paint
	Cabinet with hinged doors, no interior accessories	<b>3024HDH</b> 26 $\frac{7}{8}$ "	30"	75	\$706	+\$73
		<b>3624HDH</b> 26 $\frac{7}{8}$ "	36"	95	\$753	+\$77
		<b>4224HDH</b> 26 $\frac{7}{8}$ "	42"	110	\$801	+\$82
	Cabinet with hinged doors with 1 slotted shelf	<b>3024HDH-SH</b> 26 $\frac{7}{8}$ "	30"	85	\$796	+\$81
		<b>3624HDH-SH</b> 26 $\frac{7}{8}$ "	36"	105	\$849	+\$87
		<b>4224HDH-SH</b> 26 $\frac{7}{8}$ "	42"	115	\$897	+\$91
	Cabinet with hinged doors, no interior accessories	<b>3036HDH</b> 38 $\frac{7}{8}$ "	30"	130	\$828	+\$85
		<b>3636HDH</b> 38 $\frac{7}{8}$ "	36"	140	\$914	+\$93
		<b>4236HDH</b> 38 $\frac{7}{8}$ "	42"	150	\$1004	+\$101
	Cabinet with hinged doors with 2 slotted shelves	<b>3036HDH-SH</b> 38 $\frac{7}{8}$ "	30"	145	\$1009	+\$102
		<b>3636HDH-SH</b> 38 $\frac{7}{8}$ "	36"	155	\$1094	+\$111
		<b>4236HDH-SH</b> 38 $\frac{7}{8}$ "	42"	165	\$1185	+\$120

### Construction

Towers are of all-welded construction using 20 and 22 gauge high quality, tension leveled, cold rolled steel. The steel gauges selected for drawer fronts, bodies and accessories ensure the highest quality durability and performance for all components.

### Construction features & benefits

1. All interiors are modular and interchangeable so that cabinets can be retrofitted with new accessories and interiors as required.
2. Fully-progressive ball bearing suspensions are staged so that left and right sides work in unison. This provides smooth drawer operation with minimum force.
3. Special "claw-like" device incorporated in suspensions "grips" the fixed section of the suspension arm preventing drawer bounce-back or creep when drawer is closed.
4. 110° opening European style cupboard hinges provide smooth hinged door operation. Hinges are not visible from the exterior of the cabinet.

### Safelock™

The patented Safelock mechanism provides complete security against accidental opening of two or more drawers simultaneously. When any drawer or single pullout shelf is extended, even fractionally, Safelock ensures that all other openings, except for the 3", 4½", 6" and 7½" drawers, immediately become inoperable. Safelock is standard on all lateral files. The only exceptions are the 3", 4½", 6" and 7½" drawers.

### Drawer standard equipment

Lockers and Towers containing 3" or 6" drawers are provided with one pencil tray per cabinet. 6" drawers are additionally standard with one steel divider. 10 ½", 12" and 15" letter-width file drawers have one suspension bar for side-to-side filing of letter or legal-size folders. Optional accessories are available.

### Glides

Overall heights are inclusive of metal glides. Heights may be increased up to ⅝" by extending standard glide. Glides are accessible from inside the cabinet when the bottom drawer is fully extended or removed and may be adjusted with a ¼" socket driver.

Optional 1½" stem glides are available. Specify separately and add \$26 list to the cabinet price. Requires field installation.

### Locks

Cabinets come standard with lock. If lock is not required add suffix '**NL**' after product number. Deduct \$50 list per lock. For lock location, see the guide at the beginning of this price list.

Random keying is standard. Files may be ordered keyed alike. Specify. Locks feature removable core and are standard with two keys, one of which has a black neoprene plastic key cover.

Cabinets originally ordered as non-locking may be field installed with the addition of locking bars and a lock core. Please contact Inscape Client Services for required parts.





Master keys are available at \$45 list.

### Finishes

Refer to Finishes section for color options. For lock finish options, refer to the front of this price list.

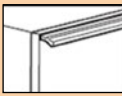
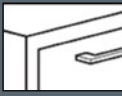
### Drawer Pulls

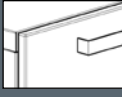
Storage with Handles have 6 styles options. FP002 is the default pull.

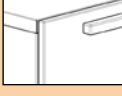
Pull	Storage with Handles	Nuform	Veneer
 FP001 P290 Aluminum Leaf Finish			
 FP002 Matte Chrome Finish			
 FP004 Brushed Nickel Finish			
 FP005 Satin Nickel Finish			
 FP007 Brushed Nickel Finish	+\$73	+\$73	+\$73
 FP008 Matte Chrome Finish	+\$73	+\$73	+\$73
 FP009 Nickel Plated Matte Finish	+\$73	+\$73	+\$73

Available

Unavailable

Pulls FP004, FP005, FP007 and FP008 meet the guidelines for ADA compliance.

**Note: FP002 is not available on hinged door cabinets.**

# Storage with Handles

## Workplace Towers

### How to order

1. Specify product number
2. Specify finish color
3. Specify options

### Product code key example

#### TR2460H-2F

- T** workplace tower  
**R** right-handed door  
**24** 24" wide  
**60** 60" interior height  
**H** Storage with Handles  
**2** number of drawers  
**F** 12" file drawer

### General information

Exterior cabinet heights are nominal. Actual heights (with glides fully recessed) are  $\frac{1}{8}$ " less. Units containing pencil and/or box drawers include one pencil tray per unit. Each box drawer contains one steel divider. Full length door contains 2-prong coat hook. Hinged door insert has two non-slotted shelves, adjustable in  $1\frac{1}{2}$ " increments. Hinged doors are standard with self closing European style hinges and open  $110^\circ$ .

### Lock Option

Workplace towers come standard with lock. If lock is not required add suffix '**NL**' after product number. Deduct \$50 list per lock.

### Finishes

Refer to finishes section for color options. Drawer bodies and accessories are finished in Eco Black.

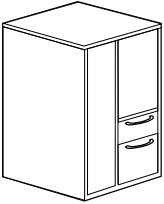
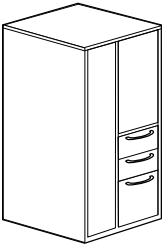
Description	Part number	Height	Depth	Weight (lbs)	Neutral paint/ base price	Accent paint
 <p>Full-length door 8 <math>\frac{3}{16}</math>" wide on one side, 27" hinged door insert, 1-7.5" file and 1-12" drawers 13 <math>\frac{5}{8}</math>" wide on the other.</p>	<b>TL2446H-B7F</b> left-handed hinged door (illustrated)	49 $\frac{3}{8}$ "	24"	118	\$2779	+\$279
	<b>TR2446H-B7F</b> right-handed hinged door	49 $\frac{3}{8}$ "	24"	118	\$2779	+\$279
 <p>Full-length door 8 <math>\frac{3}{16}</math>" wide on one side, 36" high hinged door insert, 2-6" box and 1-12" file drawers 13 <math>\frac{5}{8}</math>" wide on the other.</p>	<b>TL2460H-2BF</b> left-handed hinged door (illustrated)	62 $\frac{7}{8}$ "	24"	185	\$2779	+\$279
	<b>TR2460H-2BF</b> right-handed hinged door	62 $\frac{7}{8}$ "	24"	185	\$2779	+\$279

---

# Custom profile



# Custom profile

## Pedestals

**Specify Custom Profile pedestals without fronts and design your own using a variety of materials. The design ideas are limitless. For fabrication details, refer to the shop drawings at the end of this section.**

### ANSI/BIFMA

With the addition of counterweights where appropriate, Custom Profile pedestals meet all ANSI/BIFMA specifications.

### Construction

Pedestals are welded, “wrap-around” construction using 20 gauge high quality, tension leveled, cold rolled steel. The steel gauges selected for drawer fronts, bodies and accessories ensure the highest quality durability and performance for all components.

### Construction features & benefits

1. “Wrap-around” construction with no visible vertical seams gives a clean appearance.
2. Completely enclosed case provides rigid construction and dust-free interiors.
3. Box drawer sides are slotted on 1” centers to allow for maximum flexibility for drawer division.
4. Box drawer side double-wall construction provides clean appearance and enclosed divider slots.
5. File (12” drawer bodies have full-height sides to accommodate hanging file folders, eliminating the need for optional file frames.
6. Fully-progressive ball bearing suspensions on all drawers, including pencil and box drawers, are staged so that left and right sides work in unison. This provides smooth drawer operation with minimum force.
7. Staged suspensions allow the drawer to be completely pulled out, providing access to the entire drawer depth.
8. Special “claw-like” device incorporated in the suspension “grips” the fixed section of the suspension arm preventing drawer bounce-back or creep when drawer is closed.
9. Casters and glides are both recessed “inboard” for a uniform exterior appearance with no visible hardware.
10. Modular interior allows for complete interchangeability of drawer types within the pedestal case. For example, two 6” box drawers may be replaced by one 12” file drawer.

### Counterweights

Counterweights are required for ALL freestanding units that are not anchored or ganged to other cabinets or bolted to walls/floor.

Counterweights come standard with ALL mobile pedestals and must be field installed.

### Drawer standard equipment

3” pencil drawer, 6” box drawer and 12” file drawer are standard.

Pedestals containing 3” or 6” drawers are provided with one pencil tray per pedestal. 6” drawers are additionally standard with one steel divider.

12” file drawers have one suspension bar (two in a 28” deep pedestal for side-to-side filing of legal and letter-size folders).

### Bases

Optional base aprons are available in 2 heights and are screwed to the underside of the pedestal case. Bases may be easily added or changed on site. Pedestals are shipped with bases installed when ordered.

### Castors

4 swivel, recessed 1½” black, double-wheel phenolic carpet casters are supplied with mobile pedestals and must be field installed. Recessed casters are not visible.

### Glides

Overall heights are inclusive of metal glides or casters. Heights may be increased up to ⅝” by extending standard glide. Glides are accessible from inside the pedestal when the bottom drawer is fully extended or removed and may be adjusted with a ¼” socket driver.

Optional 1½” stem glides are available. Specify separately and add \$26 list to the pedestal price. Requires field installation.

### Locks

Pedestals come standard with lock. If lock is not required add suffix ‘NL’ after product number. Deduct \$63 list per lock. For lock location, see diagrams at the front of this price list. **Extended lock barrels are standard.** For flush, non-fascia type locks, specify separately. Mobile pedestals must include locks.

Random keying is standard. Pedestals may be ordered keyed alike. Specify. Locks feature removable core and are standard with two keys, one of which has a black neoprene plastic key cover.

Cabinets originally ordered as non-locking may be field installed with the addition of locking bars and a lock core. Please contact Inscape Client Services for required parts.

Master keys are available at \$45 list. Locks are available in Chrome and Black finish. Specify.

### Finishes

Refer to Finishes section for color options.

### How to order

1. Specify product number.
2. Specify finish color.
3. Specify options.

### Product code key example

#### 1522C-2BFM

- 15** pedestal width
- 22** pedestal depth
- C** Custom Profile Series
- 2** number of drawers
- B** box drawer
- F** file drawer
- M** mobile

### General information

Pedestals are standard with either glides or casters. Exterior pedestal heights are nominal. Actual heights (with glides fully recessed) are 1/8" less. Casters must be field installed. Pedestals with 3" and 6" drawers are standard with one pencil tray per pedestal and one steel divider per 6" drawer. 12" drawers have one suspension bar (two in a 28" deep pedestal) for side-to-side filing of letter or legal size folders.

### Counterweights

Counterweights are required for ALL freestanding units that are not anchored or ganged to other cabinets or bolted to walls/floor. Counterweights are standard with all mobile pedestals and must be field installed. See Counterweight matrix on page 023.

### Accessories

See Pedestal Accessories section for counterweights and accessories.

### Lock option

Pedestals come standard with lock. If lock is not required add suffix 'N/L' after product number. Deduct \$63 list. **Extended lock barrels are standard.**

### Finishes

Refer to Finishes section for color options. Drawer bodies and accessories are finished in Eco Black.

### Cushions

Order mobile pedestal cushions as a 'part' through your Client Services Representative.

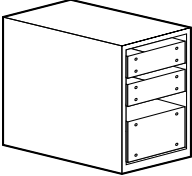
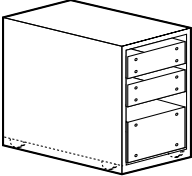
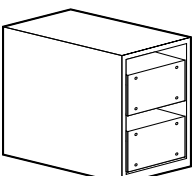
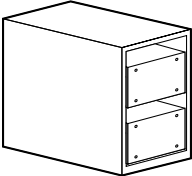
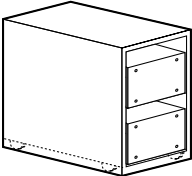
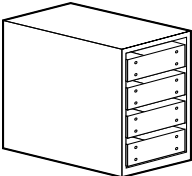
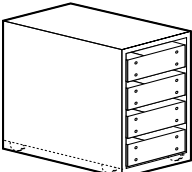
Description	Part number	Height	Depth	Weight (lbs)	Neutral paint/ base price	Accent paint
	2 box, 1 file, glides					
	<b>1518C-2BF</b>	26 7/8"	18"	70	\$815	+\$83
	<b>1522C-2BF</b>	26 7/8"	22"	80	\$908	+\$92
	2 box, 1 file, mobile, counterweight included Mobile pedestals must be locking					
	<b>1518C-2BFM</b>	27 1/2"	18"	75	\$983	+\$99
	<b>1522C-2BFM</b>	27 1/2"	22"	85	\$1078	+\$109
	2 box, 1 file, mobile, counterweight included Mobile pedestals must be locking					
	<b>1528C-2BF</b>	26 7/8"	28"	90	\$945	+\$96
	<b>1528C-2BFM</b>	26 7/8"	28"	95	\$1111	+\$113
	2 file, glides					
	<b>1518C-2F</b>	26 7/8"	18"	70	\$750	+\$77
	<b>1522C-2F</b>	26 7/8"	22"	80	\$829	+\$85
	2 file, mobile, counterweight included Mobile pedestals must be locking					
	<b>1528C-2F</b>	26 7/8"	28"	90	\$866	+\$88
	<b>1528C-2FM</b>	26 7/8"	28"	95	\$1033	+\$105
	4 box, glides					
	<b>1518C-4B</b>	26 7/8"	18"	70	\$815	+\$83
	<b>1522C-4B</b>	26 7/8"	22"	80	\$908	+\$92
	4 box, mobile, counterweight included Mobile pedestals must be locking					
	<b>1528C-4B</b>	26 7/8"	28"	90	\$945	+\$96
	<b>1528C-4BM</b>	26 7/8"	28"	95	\$1111	+\$113

# Custom Profile

## Pedestals

Freestanding, Letter

### How to order

1. Specify product number.
2. Specify finish color.
3. Specify options.

### Product code key example

#### 1522C-PBFM

- 15** pedestal width
- 22** pedestal depth
- C** Custom Profile Series
- P** pencil drawer
- B** box drawers
- F** file drawer
- M** mobile

### General information

Pedestals are standard with either glides or casters. Exterior pedestal heights are nominal. Actual heights (with glides fully recessed) are  $\frac{1}{8}$ " less. Casters must be field installed. Pedestals with 3" and 6" drawers are standard with one pencil tray per pedestal and one steel divider per 6" drawer. 12" drawers have one suspension bar (two in a 28" deep pedestal) for side-to-side filing of letter or legal size folders.

### Counterweights

Counterweights are required for ALL freestanding units that are not anchored or ganged to other cabinets or bolted to walls/floor. Counterweights are standard with all mobile pedestals and must be field installed. See Counterweight matrix on page 023..

### Accessories

See Pedestal Accessories section for counterweights and accessories.

### Lock option

Pedestals come standard with lock. If lock is not required add suffix '**NL**' after product number. Deduct \$63 list. **Extended lock barrels are standard.**

### Finishes

Refer to Finishes section for color options. Drawer bodies and accessories are finished in Eco Black.

### Cushions

Order mobile pedestal cushions as a 'part' through your Client Services Representative.

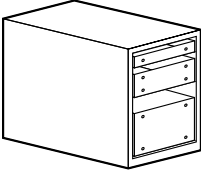
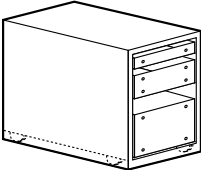
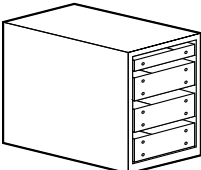
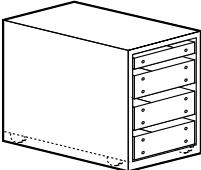
Description	Part number	Height	Depth	Weight (lbs)	Neutral paint/ base price	Accent paint
	1 pencil, 1 box, 1 file, glides	<b>1518C-PBF</b>	23 $\frac{7}{8}$ "	18"	65	\$815 +\$83
		<b>1522C-PBF</b>	23 $\frac{7}{8}$ "	22"	75	\$908 +\$92
		<b>1528C-PBF</b>	23 $\frac{7}{8}$ "	28"	85	\$945 +\$96
	1 pencil, 1 box, 1 file, mobile, counterweight included	<b>1518C-PBFM</b>	24 $\frac{1}{2}$ "	18"	70	\$983 +\$99
		<b>1522C-PBFM</b>	24 $\frac{1}{2}$ "	22"	80	\$1078 +\$109
	Mobile pedestals must be locking	<b>1528C-PBFM</b>	24 $\frac{1}{2}$ "	28"	90	\$1111 +\$113
	1 pencil, 3 box, glides	<b>1518C-P3B</b>	23 $\frac{7}{8}$ "	18"	65	\$815 +\$83
		<b>1522C-P3B</b>	23 $\frac{7}{8}$ "	22"	75	\$908 +\$92
		<b>1528C-P3B</b>	23 $\frac{7}{8}$ "	28"	85	\$945 +\$96
	1 pencil, 3 box, mobile, counterweight included	<b>1518C-P3BM</b>	24 $\frac{1}{2}$ "	18"	70	\$983 +\$99
		<b>1522C-P3BM</b>	24 $\frac{1}{2}$ "	22"	80	\$1078 +\$109
	Mobile pedestals must be locking	<b>1528C-P3BM</b>	24 $\frac{1}{2}$ "	28"	90	\$1111 +\$113

**Specify Custom Profile lateral or hinged door cabinets without fronts and design your own using a variety of materials. The design ideas are limitless. For fabrication details, refer to the shop drawings at the end of this section.**

### ANSI/BIFMA

With the addition of counterweights where appropriate, Custom Profile lateral files meet all ANSI/BIFMA specifications.

### Construction

Lateral files and hinged door cabinets are of all-welded construction using 20 and 22 gauge high quality, tension leveled, cold rolled steel. The steel gauges selected for drawer fronts, bodies and accessories ensure the highest quality durability and performance for all components.

### Construction features & benefits

1. All interiors are modular and interchangeable so that cabinets can be retrofitted with new accessories and interiors.
2. Corners are strengthened with a reinforcing gusset and are welded at junction of top and case, eliminating horizontal lines for a cleaner, flush appearance on the face of the cabinet.
3. Fully-progressive ball bearing suspensions are staged so that left and right sides work in unison. This provides smooth drawer operation with minimum force.
4. Special "claw-like" device incorporated in suspensions "grips" the fixed section of the suspension arm preventing drawer bounce-back or creep when drawer is closed.
5. Lock bars operate vertically on both sides of the cabinet for maximum security.
6. Lock fingers are configured with right angle bend upward, not downward, so that lift-up doors cannot be pulled down to disengage fingers from door slots and be forced to circumvent lock system.
7. Self-closing, 110° opening, European style cupboard hinges provide smooth hinged door operation. Hinges are not visible from the exterior of the cabinet.

### Safelock™

The patented Safelock mechanism provides complete security against accidental opening of two or more drawers simultaneously. When any drawer or shelf is extended, even fractionally, Safelock ensures that all other openings, except for the 3" drawer, immediately become inoperable. Safelock is standard on all lateral files.

### Counterweights

Counterweights are required for ALL freestanding units that are not anchored or ganged to other cabinets or bolted to walls/floor.

### Drawer standard equipment

Pullout drawers are standard with one pair hangfile bars for side-to-side suspended filing. Optional accessories are available.

### Bases

Optional base aprons are available in 2 heights and are screwed to the underside of the cabinet. Bases may be easily added or changed on site. Cabinets are shipped with bases installed with ordered.

### Glides

Overall heights are inclusive of metal glides. Heights may be increased up to 5/8" by extending standard glide. Standard glides may be used with or without base aprons. Glides are accessible from inside the cabinet when the bottom drawer is fully extended or removed and may be adjusted with a 1/4" socket driver.

Optional 1 1/2" stem glides are available. Specify separately and add \$26 list to the cabinet price. Requires field installation.

### Locks

Cabinets come standard with lock. If lock is not required add suffix 'NL' after product number. Deduct \$63 list per lock. For lock location, see the front of this price list. **Extended lock barrels are standard.** For flush, non-fascia type locks, specify separately.

Random keying is standard. Files may be ordered keyed alike. Specify. Locks feature removable core and are standard with two keys, one of which features a black neoprene plastic cover.

Cabinets originally ordered as non-locking may be field installed with the addition of locking bars and a lock core. Please contact Inscope Client Services for required parts. Locks may not be field installed in hinged door cabinets.

Master keys are available at \$45 list. For lock finish options, refer to the front of this price list.

### Finishes

Refer to the Finishes section at the front of this price list.

### Case height matrix

Interior height		Exterior height	
in.	mm	in.	mm
15"	381	17 7/8"	454
16 1/2"	419	19 3/8"	492
18"	457	20 7/8"	530
19 1/2"	495	22 3/8"	568
21"	533	23 7/8"	606
22 1/2"	572	25 3/8"	645
24"	610	26 7/8"	683
25 1/2"	648	28 3/8"	721
27"	686	29 7/8"	759
28 1/2"	724	31 3/8"	797
30"	762	32 7/8"	835
31 1/2"	800	34 3/8"	873
33"	838	35 7/8"	911
34 1/2"	876	37 3/8"	949
36"	914	38 7/8"	987
37 1/2"	953	40 3/8"	1026
39"	991	41 7/8"	1064
40 1/2"	1029	43 3/8"	1102
42"	1067	44 7/8"	1140
43 1/2"	1105	46 3/8"	1178
45"	1143	47 7/8"	1216
46 1/2"	1181	49 3/8"	1254
48"	1219	50 7/8"	1292
49 1/2"	1257	52 3/8"	1330
51"	1295	53 7/8"	1368
52 1/2"	1334	55 3/8"	1407
54"	1372	56 7/8"	1445
55 1/2"	1410	58 3/8"	1483
57"	1448	59 7/8"	1521
58 1/2"	1486	61 3/8"	1559
60"	1524	62 7/8"	1597
61 1/2"	1562	64 3/8"	1635
63"	1600	65 7/8"	1673
64 1/2"	1638	67 3/8"	1711
66"	1676	68 7/8"	1749
67 1/2"	1715	70 3/8"	1788
69"	1753	71 7/8"	1826
70 1/2"	1791	73 3/8"	1864
72"	1829	74 7/8"	1902
73 1/2"	1867	76 3/8"	1940
75"	1905	77 7/8"	1978
76 1/2"	1943	79 3/8"	2016



# Custom Profile

## Laterals

Letter/Legal Size Media

### How to order

1. Specify product number.
2. Specify finish color.
3. Specify options.

### Product code key example

#### 36-24-2BFC

- 36** cabinet width  
**24** interior height  
**2** number of drawers  
**B** 6" box drawer  
**F** 12" file drawer  
**C** Custom Profile Series

### General information

These cabinets are complete assembled units without drawer or door fronts. Prices do not include fronts. See the shop drawings at the end of this section for information about the fabrication and installation of custom fronts. Exterior cabinet heights are nominal. Actual heights (with glides fully recessed) are  $\frac{1}{8}$ " less. Cabinets are priced inclusive of 1 pair of hangfile bars in each pullout opening, 1 EDP kit in each 15" opening.

**Cabinets are 18" in depth.**

### Counterweights

Counterweights are required for ALL freestanding units that are not anchored or ganged to other cabinets or bolted to walls/floor. See Counterweight matrix on page 023.

### Accessories

See Lateral File Accessories section for counterweights and accessories.

### Lock option

Cabinets come standard with lock. If lock is not required add suffix '/NL' after product number. Deduct \$63 list. **Extended lock barrels are standard.**

### Finishes

Refer to Finishes section for color options. Drawer bodies and accessories are finished in Eco Black.

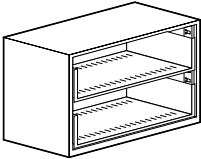
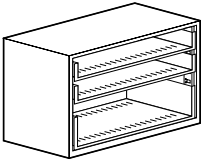
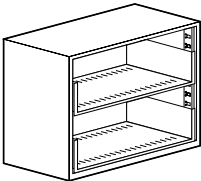
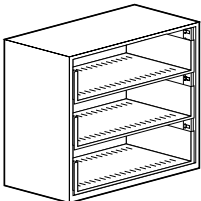
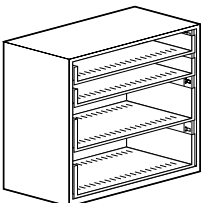
Description	Part number	Height	Depth	Weight (lbs)	Neutral paint/ base price	Accent paint
 Cabinet with 2-12" drawers, no fronts	<b>30-2FFC</b>	26 $\frac{7}{8}$ "	30"	72	\$940	+\$95
	<b>36-2FFC</b>	26 $\frac{7}{8}$ "	36"	90	\$1027	+\$105
	<b>42-2FFC</b>	26 $\frac{7}{8}$ "	42"	108	\$1129	+\$114
 Cabinet with top 2 openings 6" drawers, bottom opening 12" drawer, no fronts	<b>30-24-2BFC</b>	26 $\frac{7}{8}$ "	30"	72	\$1055	+\$107
	<b>36-24-2BFC</b>	26 $\frac{7}{8}$ "	36"	90	\$1161	+\$117
	<b>42-24-2BFC</b>	26 $\frac{7}{8}$ "	42"	108	\$1277	+\$128
 Cabinet with 2-15" drawers, no fronts	<b>30-30-2EDPC</b>	32 $\frac{7}{8}$ "	30"	76	\$1154	+\$117
	<b>36-30-2EDPC</b>	32 $\frac{7}{8}$ "	36"	94	\$1227	+\$124
	<b>42-30-2EDPC</b>	32 $\frac{7}{8}$ "	42"	112	\$1357	+\$136
 Cabinet with 3-12" drawers, no fronts	<b>30-3FFC</b>	38 $\frac{7}{8}$ "	30"	100	\$1253	+\$126
	<b>36-3FFC</b>	38 $\frac{7}{8}$ "	36"	117	\$1378	+\$139
	<b>42-3FFC</b>	38 $\frac{7}{8}$ "	42"	134	\$1545	+\$156
 Cabinet with top 2 openings 6" drawers, bottom 2 openings 12" drawers, no fronts	<b>30-36-2B2FC</b>	38 $\frac{7}{8}$ "	30"	100	\$1368	+\$137
	<b>36-36-2B2FC</b>	38 $\frac{7}{8}$ "	36"	117	\$1514	+\$153
	<b>42-36-2B2FC</b>	38 $\frac{7}{8}$ "	42"	134	\$1695	+\$170

### How to order

1. Specify product number.
2. Specify finish color.
3. Specify options.

### Product code key example

#### 36-24-3EDPC

- 36** cabinet width
- 24** interior height
- 3** number of drawers
- EDP** EDP kit
- C** Custom Profile Series

### General information

These cabinets are complete assembled units without drawer or door fronts. Prices do not include fronts. See the shop drawings at the end of this section for information about the fabrication and installation of custom fronts. Exterior cabinet heights are nominal. Actual heights (with glides fully recessed) are  $\frac{1}{8}$ " less. Cabinets are priced inclusive of 1 pair of hangfile bars in each pullout opening, 1 EDP kit in each 15" opening.

**Cabinets are 18" in depth.**

### Counterweights

Counterweights are required for ALL freestanding units that are not anchored or ganged to other cabinets or bolted to walls/floor. See Counterweight matrix on page 023.

### Accessories

See Lateral File Accessories section for counterweights and accessories.

### Lock option

Cabinets come standard with lock. If lock is not required add suffix **'/NL'** after product number. Deduct \$63 list. **Extended lock barrels are standard.**

### Finishes

Refer to Finishes section for color options. Drawer bodies and accessories are finished in Eco Black.

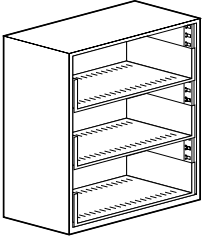
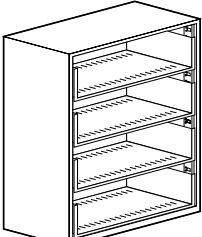
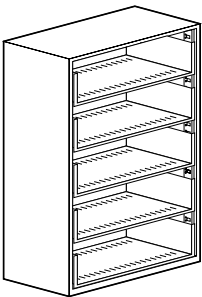
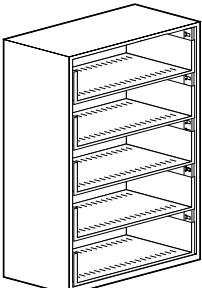
Description	Part number	Height	Depth	Weight (lbs)	Neutral paint/ base price	Accent paint
 Cabinet with 3-15" drawers, no fronts	<b>30-45-3EDPC</b>	47 $\frac{7}{8}$ "	30"	104	\$1503	+\$152
	<b>36-45-3EDPC</b>	47 $\frac{7}{8}$ "	36"	121	\$1698	+\$171
	<b>42-45-3EDPC</b>	47 $\frac{7}{8}$ "	42"	138	\$1906	+\$192
 Cabinet with 4-12" drawers, no fronts	<b>30-4FFC</b>	50 $\frac{7}{8}$ "	30"	130	\$1525	+\$154
	<b>36-4FFC</b>	50 $\frac{7}{8}$ "	36"	146	\$1777	+\$179
	<b>42-4FFC</b>	50 $\frac{7}{8}$ "	42"	162	\$2015	+\$202
 Cabinet with 4-15" drawers, no fronts	<b>30-60-4EDPC</b>	62 $\frac{7}{8}$ "	30"	134	\$1860	+\$187
	<b>36-60-4EDPC</b>	62 $\frac{7}{8}$ "	36"	150	\$2057	+\$206
	<b>42-60-4EDPC</b>	62 $\frac{7}{8}$ "	42"	166	\$2304	+\$232
 Cabinet with 5-12" drawers, no fronts	<b>30-5FFC</b>	62 $\frac{7}{8}$ "	30"	134	\$1808	+\$182
	<b>36-5FFC</b>	62 $\frac{7}{8}$ "	36"	150	\$2067	+\$208
	<b>42-5FFC</b>	62 $\frac{7}{8}$ "	42"	166	\$2349	+\$236

# Custom Profile

## Laterals Multi-units

### How to order

1. Specify product number.
2. Specify finish color.
3. Specify options.

### Product code key example

#### 36-48-2BFC

- 36** cabinet width  
**48** interior height  
**2** number of drawers  
**B** 6" box drawer  
**F** 12" file drawer  
**C** Custom Profile Series

### General information

These cabinets are complete assembled units without drawer or door fronts. Prices do not include fronts. See the shop drawings at the end of this section for information about the fabrication and installation of custom fronts. Exterior cabinet heights are nominal. Actual heights (with glides fully recessed) are  $\frac{1}{8}$ " less. Cabinets are priced inclusive of 1 pair of hangfile bars in each pullout opening, 1 EDP kit in each 15" opening.

**Cabinets are 18" in depth.**

### Counterweights

Counterweights are required for ALL freestanding units that are not anchored or ganged to other cabinets or bolted to walls/floor. See Counterweight matrix on page 023.

### Accessories

See Lateral File Accessories section for counterweights and accessories.

### Lock option

Cabinets come standard with lock. If lock is not required add suffix '/NL' after product number. Deduct \$63 list. **Extended lock barrels are standard.**

### Finishes

Refer to Finishes section for color options. Drawer bodies and accessories are finished in Eco Black.

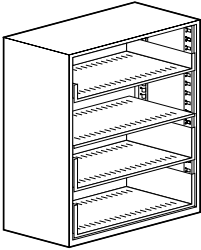
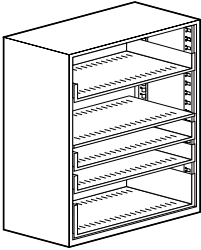
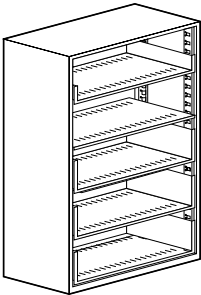
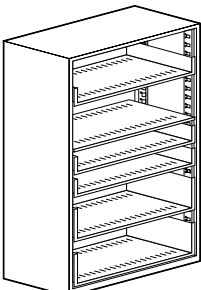
Description	Part number	Height	Depth	Weight (lbs)	Neutral paint/ base price	Accent paint	
	Cabinet with top opening 24" cupboard insert, other 2 openings 12" drawers, no doors or fronts	<b>30-48-HD2FC</b>	50 $\frac{7}{8}$ "	30"	58	\$1518	+\$154
		<b>36-48-HD2FC</b>	50 $\frac{7}{8}$ "	36"	70	\$1736	+\$175
		<b>42-48-HD2FC</b>	50 $\frac{7}{8}$ "	42"	82	\$1953	+\$196
	Cabinet with top opening 24" cupboard insert, next 2 openings 6" drawers, bottom opening 12" drawer, no doors or fronts	<b>30-48-HD2BFC</b>	50 $\frac{7}{8}$ "	30"	61	\$1634	+\$165
		<b>36-48-HD2BFC</b>	50 $\frac{7}{8}$ "	36"	73	\$1870	+\$188
		<b>42-48-HD2BFC</b>	50 $\frac{7}{8}$ "	42"	85	\$2103	+\$212
	Cabinet with top opening 24" cupboard insert, other 3 openings 12", drawers, no doors or fronts	<b>30-60-HD3FC</b>	62 $\frac{7}{8}$ "	30"	71	\$1800	+\$182
		<b>36-60-HD3FC</b>	62 $\frac{7}{8}$ "	36"	91	\$2030	+\$203
		<b>42-60-HD3FC</b>	62 $\frac{7}{8}$ "	42"	101	\$2285	+\$230
	Cabinet with top opening 24" cupboard insert, next 2 openings 6" drawers, bottom 2 openings 12" drawers, no doors or fronts	<b>30-60-HD2B2FC</b>	62 $\frac{7}{8}$ "	30"	74	\$1915	+\$193
		<b>36-60-HD2B2FC</b>	62 $\frac{7}{8}$ "	36"	94	\$2163	+\$218
		<b>42-60-HD2B2FC</b>	62 $\frac{7}{8}$ "	42"	104	\$2434	+\$245

#### How to order

1. Specify product number.
2. Specify finish color.
3. Specify options.

#### Product code key example

##### 3624HDC-SH

- 36** cabinet width  
**24** interior height  
**HD** hinged doors  
**C** Custom Profile Series  
**SH** shelf

#### General information

These cabinets are complete assembled units without door fronts. Prices do not include door fronts. See the shop drawings at the end of this section for information about the fabrication and installation of custom fronts. Exterior cabinet heights are nominal. Actual heights (with glides fully recessed) are  $\frac{1}{8}$ " less. Standard hardware is self-closing European style hinges that open 110°. Shelves are slotted every  $1\frac{1}{2}$ " and are height adjustable in  $1\frac{1}{2}$ " increments. Shelf dividers are not included.

**Cabinets are 18" in depth.**

#### Lock option

Cabinets come standard with lock. If lock is not required add suffix '**NL**' after product number. Deduct \$63 list. **Extended lock barrels are standard.**

#### Finishes

Refer to Finishes section for color options. Drawer bodies and accessories are finished in Eco Black.

#### Accessories

See Lateral File Accessories section for counterweights and accessories.

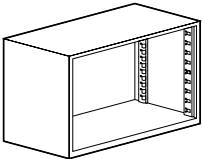
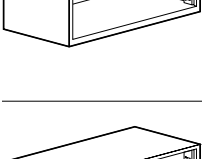
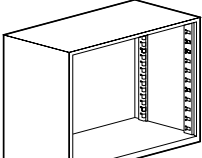
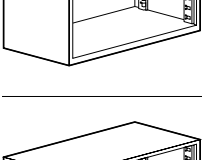
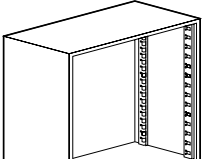
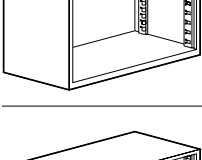
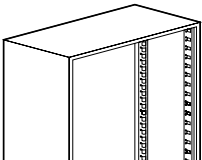
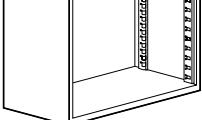
Description	Part number	Height	Depth	Weight (lbs)	Neutral paint/ base price	Accent paint	
	Cabinet with no interior accessories, no doors	<b>3024HDC</b>	26 $\frac{7}{8}$ "	30"	38	\$635	+\$64
		<b>3624HDC</b>	26 $\frac{7}{8}$ "	36"	46	\$663	+\$67
		<b>4224HDC</b>	26 $\frac{7}{8}$ "	42"	54	\$704	+\$73
	Cabinet with 1 slotted shelf, no doors	<b>3024HDC-SH</b>	26 $\frac{7}{8}$ "	30"	48	\$725	+\$75
		<b>3624HDC-SH</b>	26 $\frac{7}{8}$ "	36"	57	\$752	+\$77
		<b>4224HDC-SH</b>	26 $\frac{7}{8}$ "	42"	66	\$792	+\$81
	Cabinet with no interior accessories, no doors	<b>3030HDC</b>	32 $\frac{7}{8}$ "	30"	43	\$701	+\$72
		<b>3630HDC</b>	32 $\frac{7}{8}$ "	36"	52	\$729	+\$75
		<b>4230HDC</b>	32 $\frac{7}{8}$ "	42"	61	\$804	+\$82
	Cabinet with 1 slotted shelf, no doors	<b>3030HDC-SH</b>	32 $\frac{7}{8}$ "	30"	53	\$787	+\$81
		<b>3630HDC-SH</b>	32 $\frac{7}{8}$ "	36"	63	\$817	+\$84
		<b>4230HDC-SH</b>	32 $\frac{7}{8}$ "	42"	73	\$890	+\$91
	Cabinet with no interior accessories, no doors	<b>3036HDC</b>	38 $\frac{7}{8}$ "	30"	48	\$712	+\$73
		<b>3636HDC</b>	38 $\frac{7}{8}$ "	36"	58	\$757	+\$78
		<b>4236HDC</b>	38 $\frac{7}{8}$ "	42"	68	\$830	+\$85
	Cabinet with 2 slotted shelves, no doors	<b>3036HDC-SH</b>	38 $\frac{7}{8}$ "	30"	58	\$888	+\$90
		<b>3636HDC-SH</b>	38 $\frac{7}{8}$ "	36"	68	\$934	+\$95
		<b>4236HDC-SH</b>	38 $\frac{7}{8}$ "	42"	78	\$1009	+\$102
	Cabinet with no interior accessories, no doors	<b>3045HDC</b>	47 $\frac{7}{8}$ "	30"	56	\$910	+\$92
		<b>3645HDC</b>	47 $\frac{7}{8}$ "	36"	68	\$950	+\$96
		<b>4245HDC</b>	47 $\frac{7}{8}$ "	42"	80	\$1076	+\$109
	Cabinet with 2 slotted shelves, no doors	<b>3045HDC-SH</b>	47 $\frac{7}{8}$ "	30"	86	\$1096	+\$111
		<b>3645HDC-SH</b>	47 $\frac{7}{8}$ "	36"	99	\$1129	+\$114
		<b>4245HDC-SH</b>	47 $\frac{7}{8}$ "	42"	112	\$1251	+\$126

# Custom Profile

## Laterals

Storage and Wardrobe Cabinets

### How to order

1. Specify product number.
2. Specify finish color.
3. Specify options.

### Product code key example

#### 3648HDC-SH

- 36** cabinet width  
**48** interior height  
**HD** hinged door  
**C** Custom Profile Series  
**SH** shelf

### General information

These cabinets are complete assembled units without or door fronts. Prices do not include fronts. See the shop drawings at the end of this section for information about the fabrication and installation of custom fronts. Exterior cabinet heights are nominal. Actual heights (with glides fully recessed) are  $\frac{1}{8}$ " less. Standard hardware is self-closing European style hinges that open 110°. Shelves are slotted every 1½" and are height adjustable in 1½" increments. Shelf dividers are not included.

**Cabinets are 18" in depth.**

### Lock option

Cabinets come standard with lock. If lock is not required add suffix '**NL**' after product number. Deduct \$63 list. **Extended lock barrels are standard.**

### Finishes

Refer to Finishes section for color options. Drawer bodies and accessories are finished in Eco Black.

### Accessories

See Lateral File Accessories section for counterweights and accessories.

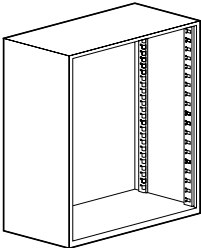
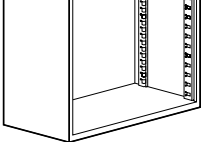
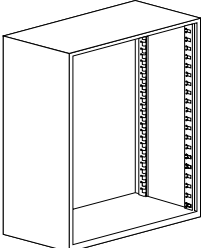
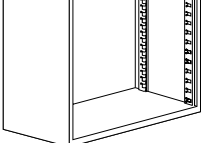
Description	Part number	Height	Depth	Weight (lbs)	Neutral paint/ base price	Accent paint	
	Cabinet with no interior accessories, no doors	<b>3048HDC</b>	50 7/8"	30"	58	\$828	+\$85
		<b>3648HDC</b>	50 7/8"	36"	70	\$954	+\$97
		<b>4248HDC</b>	50 7/8"	42"	82	\$1078	+\$109
	Cabinet with 2 slotted shelves, no doors	<b>3048HDC-SH</b>	50 7/8"	30"	88	\$1006	+\$102
		<b>3648HDC-SH</b>	50 7/8"	36"	103	\$1131	+\$115
		<b>4248HDC-SH</b>	50 7/8"	42"	118	\$1253	+\$126
	Cabinet with no interior accessories, no doors	<b>3049.5HDC</b>	52 3/8"	30"	59	\$843	+\$86
		<b>3649.5HDC</b>	52 3/8"	36"	71	\$955	+\$97
		<b>4249.5HDC</b>	52 3/8"	42"	83	\$1079	+\$110
	Cabinet with 2 slotted shelves, no doors	<b>3049.5HDC-SH</b>	52 3/8"	30"	89	\$1021	+\$103
		<b>3649.5HDC-SH</b>	52 3/8"	36"	104	\$1132	+\$115
		<b>4249.5HDC-SH</b>	52 3/8"	42"	119	\$1254	+\$126

#### How to order

1. Specify product number.
2. Specify finish color.
3. Specify options.

#### Product code key example

##### 3660HDC-WS

- 36** cabinet width  
**60** interior height  
**HD** hinged doors  
**C** Custom Profile Series  
**WS** shelves with coat rod

#### General information

These cabinets are complete assembled units without or door fronts. Prices do not include door fronts. See the shop drawings at the end of this section for information about the fabrication and installation of custom fronts. Exterior cabinet heights are nominal. Actual heights (with glides fully recessed) are 1/8" less. Standard hardware is self-closing European style hinges that open 110°. Shelves are slotted every 1 1/2" and are height adjustable in 1 1/2" increments. Shelf dividers are not included.

**Cabinets are 18" in depth.**

#### Lock option



Cabinets come standard with lock. If lock is not required add suffix '/NL' after product number. Deduct \$63 list. **Extended lock barrels are standard.**

#### Finishes

Refer to Finishes section for color options. Drawer bodies and accessories are finished in Eco Black.

#### Accessories

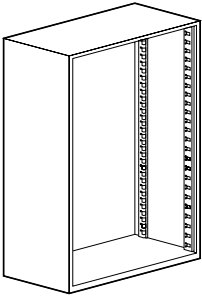
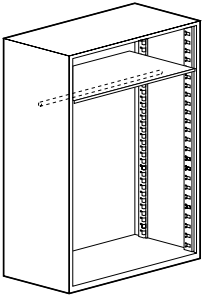
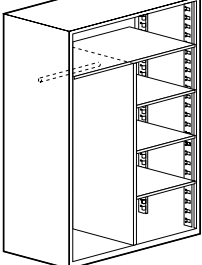
See Lateral File Accessories section for counterweights and accessories.

Description	Part number	Height	Depth	Weight (lbs)	Neutral paint/ base price	Accent paint
	<b>3060HDC</b>	62 7/8"	30"	68	\$812	+\$83
	<b>3660HDC</b>	62 7/8"	36"	82	\$927	+\$94
	<b>4260HDC</b>	62 7/8"	42"	96	\$1057	+\$107
	<b>3060HDC-SH</b>	62 7/8"	30"	98	\$1078	+\$109
	<b>3660HDC-SH</b>	62 7/8"	36"	115	\$1193	+\$120
	<b>4260HDC-SH</b>	62 7/8"	42"	132	\$1324	+\$133
	<b>3060HDC-W</b>	62 7/8"	30"	78	\$932	+\$94
	<b>3660HDC-W</b>	62 7/8"	36"	95	\$1048	+\$107
	<b>4260HDC-W</b>	62 7/8"	42"	112	\$1180	+\$119
	<b>3060HDC-WS</b>	62 7/8"	30"	88	\$1137	+\$115
	<b>3660HDC-WS</b>	62 7/8"	36"	105	\$1252	+\$126
	<b>4260HDC-WS</b>	62 7/8"	42"	122	\$1385	+\$140

# Custom Profile

## Laterals

Storage and Wardrobe Cabinets

### How to order

1. Specify product number.
2. Specify finish color.
3. Specify options.

### Product code key example

**3673.5HDC**

- 36** cabinet width  
**73.5** interior height  
**HD** hinged doors  
**C** Custom Profile Series  
**SH** shelves

### General information

These cabinets are complete assembled units without or door fronts. Prices do not include fronts. See the shop drawings at the end of this section for information about the fabrication and installation of custom fronts. Exterior cabinet heights are nominal. Actual heights (with glides fully recessed) are  $\frac{1}{8}$ " less. Standard hardware is self-closing European style hinges that open 110°. Shelves are slotted every 1½" and are height adjustable in 1½" increments. Shelf dividers are not included.

**Cabinets are 18" in depth.**

### Lock option

Cabinets come standard with lock. If lock is not required add suffix '**NL**' after product number. Deduct \$63 list. **Extended lock barrels are standard.**

### Finishes

Refer to Finishes section for color options. Drawer bodies and accessories are finished in Eco Black.

### Accessories

See Lateral File Accessories section for counterweights and accessories.

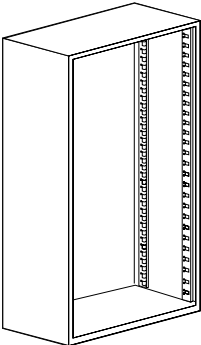
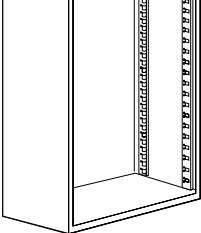
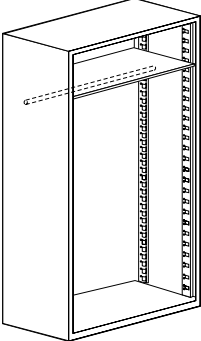
Description	Part number	Height	Depth	Weight (lbs)	Neutral paint/ base price	Accent paint
	<b>3073.5HDC</b>	76 $\frac{3}{8}$ "	30"	81	\$983	+\$99
	<b>3673.5HDC</b>	76 $\frac{3}{8}$ "	36"	92	\$1132	+\$115
	<b>4273.5HDC</b>	76 $\frac{3}{8}$ "	42"	104	\$1270	+\$128
	<b>3073.5HDC-SH</b>	76 $\frac{3}{8}$ "	30"	121	\$1338	+\$134
	<b>3673.5HDC-SH</b>	76 $\frac{3}{8}$ "	36"	136	\$1487	+\$151
	<b>4273.5HDC-SH</b>	76 $\frac{3}{8}$ "	42"	152	\$1625	+\$164
	<b>3073.5HDC-W</b>	76 $\frac{3}{8}$ "	30"	91	\$1103	+\$112
	<b>3673.5HDC-W</b>	76 $\frac{3}{8}$ "	36"	105	\$1252	+\$126
	<b>4273.5HDC-W</b>	76 $\frac{3}{8}$ "	42"	120	\$1392	+\$142

### How to order

1. Specify basic cabinet product number.
2. Specify cabinet interiors from TOP to BOTTOM.
3. Specify accessories, see Accessories section.
4. Specify finish color.
5. If lock is not required add suffix **'/NL'** after product number. Deduct \$63 list.

### Product code key example 30-15C

- 30** cabinet width  
**15** cabinet interior clear height  
**C** Custom Profile Series

### General information

Cases in this section are basic empty units without doors, drawers or accessories. Specify cabinet components and accessories on the following pages ensuring the total height of the selected components equals the total interior clear height of the case. Cabinets are available in 42" case heights and 3" widths. Interior components are available in 3", 6", 10½", 12", 13½", 15" and 24" sizes. (Note: 3" drawers specified in a bottom opening, above a 1½" filler or above a reference shelf cannot be locked.) ⅝" glides are standard and can be used with or without base aprons. Counterweights are recommended.

**Cabinets are 18" in depth.**

### Counterweights

Counterweights are required for ALL freestanding units that are not anchored or ganged to other cabinets or bolted to walls/floor. See Counterweight matrix on page 023.

### Finishes

Refer to Finishes section for color options.

**Note: Exterior cabinet heights shown below are nominal. Actual heights, with glides fully recessed, are ⅛" less.**

**Cabinets 64 ⅜" and over include a hidden tie bar in their construction.**

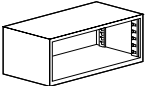
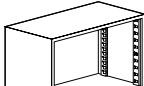
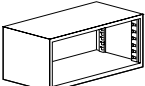
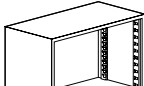
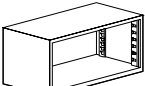
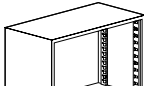
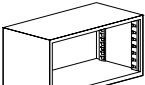
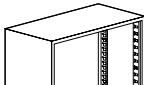
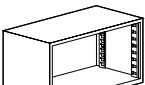
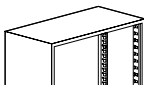
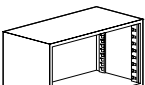
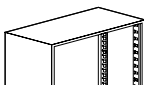
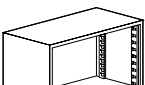
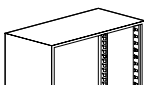
	Interior height	Exterior height	Part number	Neutral paint/ base price	Accent paint		Interior height	Exterior height	Part number	Neutral paint/ base price	Accent paint
	15"	17 ⅞"	<b>30-15C</b> <b>36-15C</b> <b>42-15C</b>	\$443 \$488 \$522	+\$46 +\$50 +\$53		25 ½"	28 ⅜"	<b>30-25.5C</b> <b>36-25.5C</b> <b>42-25.5C</b>	\$512 \$515 \$563	+\$52 +\$53 +\$57
	16 ½"	19 ⅜"	<b>30-16.5C</b> <b>36-16.5C</b> <b>42-16.5C</b>	\$459 \$495 \$524	+\$47 +\$51 +\$53		27"	29 ⅞"	<b>30-27C</b> <b>36-27C</b> <b>42-27C</b>	\$521 \$536 \$594	+\$53 +\$55 +\$60
	18"	20 ⅞"	<b>30-18C</b> <b>36-18C</b> <b>42-18C</b>	\$462 \$496 \$530	+\$48 +\$51 +\$54		28 ½"	31 ⅜"	<b>30-28.5C</b> <b>36-28.5C</b> <b>42-28.5C</b>	\$536 \$554 \$618	+\$55 +\$56 +\$63
	19 ½"	22 ⅜"	<b>30-19.5C</b> <b>36-19.5C</b> <b>42-19.5C</b>	\$464 \$497 \$536	+\$48 +\$51 +\$55		30"	32 ⅞"	<b>30-30C</b> <b>36-30C</b> <b>42-30C</b>	\$537 \$573 \$647	+\$55 +\$58 +\$65
	21"	23 ⅞"	<b>30-21C</b> <b>36-21C</b> <b>42-21C</b>	\$465 \$498 \$538	+\$48 +\$51 +\$55		31 ½"	34 ⅜"	<b>30-31.5C</b> <b>36-31.5C</b> <b>42-31.5C</b>	\$538 \$577 \$648	+\$55 +\$59 +\$65
	22 ½"	25 ⅜"	<b>30-22.5C</b> <b>36-22.5C</b> <b>42-22.5C</b>	\$466 \$499 \$539	+\$48 +\$51 +\$55		33"	35 ⅞"	<b>30-33C</b> <b>36-33C</b> <b>42-33C</b>	\$539 \$580 \$655	+\$55 +\$59 +\$66
	24"	26 ⅞"	<b>30-24C</b> <b>36-24C</b> <b>42-24C</b>	\$467 \$500 \$541	+\$48 +\$51 +\$55		34 ½"	37 ⅜"	<b>30-34.5C</b> <b>36-34.5C</b> <b>42-34.5C</b>	\$541 \$586 \$666	+\$55 +\$59 +\$67



# Custom Profile

## Build-Ups

### Basic Lateral Cabinets

#### How to order

1. Specify basic cabinet product number.
2. Specify cabinet interiors from TOP to BOTTOM.
3. Specify accessories, see Accessories section.
4. Specify finish color.
5. If lock is not required add suffix 'NL' after product number. Deduct \$63 list.

#### Product code key example

##### 30-36C

- 30** cabinet width  
**36** cabinet interior clear height  
**C** Custom Profile Series

#### General information

Cases in this section are basic empty units without doors, drawers or accessories. Specify cabinet components and accessories on the following pages ensuring the total height of the selected components equals the total interior clear height of the case. Cabinets are available in 42" case heights and 3" widths. Interior components are available in 3", 6", 10½", 12", 13½", 15" and 24" sizes. (Note: 3" drawers specified in a bottom opening, above a 1½" filler or above a reference shelf cannot be locked.) ⅝" glides are standard and can be used with or without base aprons. Counterweights are recommended.

**Cabinets are 18" in depth.**

#### Counterweights

Counterweights are required for ALL freestanding units that are not anchored or ganged to other cabinets or bolted to walls/floor. See Counterweight matrix on page 023.

#### Finishes

Refer to Finishes section for color options.

**Note: Exterior cabinet heights shown below are nominal. Actual heights, with glides fully recessed, are ⅛" less.**

**Cabinets 64 ⅜" and over include a hidden tie bar in their construction.**

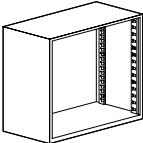
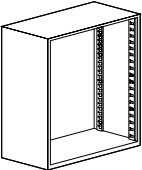
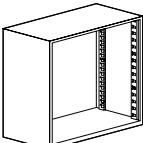
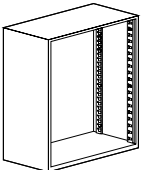
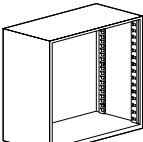
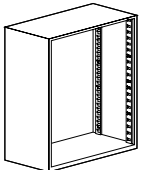
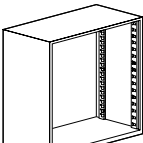
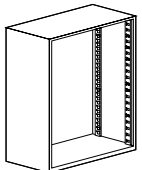
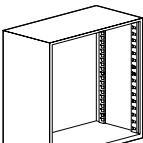
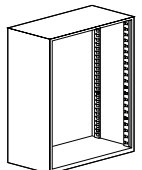
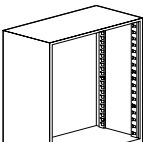
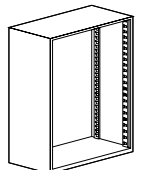
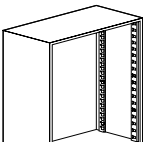
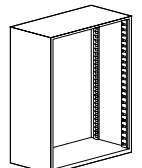
	Interior height	Exterior height	Part number	Neutral paint/ base price	Accent paint		Interior height	Exterior height	Part number	Neutral paint/ base price	Accent paint
	36"	38 ⅞"	<b>30-36C</b> <b>36-36C</b> <b>42-36C</b>	\$544 \$588 \$666	+\$55 +\$60 +\$67		46 ½"	49 ⅜"	<b>30-46.5C</b> <b>36-46.5C</b> <b>42-46.5C</b>	\$580 \$719 \$843	+\$59 +\$74 +\$86
	37 ½"	40 ⅜"	<b>30-37.5C</b> <b>36-37.5C</b> <b>42-37.5C</b>	\$555 \$607 \$696	+\$56 +\$61 +\$72		48"	50 ⅞"	<b>30-48C</b> <b>36-48C</b> <b>42-48C</b>	\$581 \$720 \$846	+\$59 +\$74 +\$86
	39"	41 ⅞"	<b>30-39C</b> <b>36-39C</b> <b>42-39C</b>	\$564 \$628 \$719	+\$57 +\$63 +\$74		49 ½"	52 ⅜"	<b>30-49.5C</b> <b>36-49.5C</b> <b>42-49.5C</b>	\$594 \$723 \$847	+\$60 +\$74 +\$86
	40 ½"	43 ⅜"	<b>30-40.5C</b> <b>36-40.5C</b> <b>42-40.5C</b>	\$567 \$652 \$752	+\$58 +\$66 +\$77		51"	53 ⅞"	<b>30-51C</b> <b>36-51C</b> <b>42-51C</b>	\$609 \$727 \$853	+\$62 +\$75 +\$87
	42"	44 ⅞"	<b>30-42C</b> <b>36-42C</b> <b>42-42C</b>	\$574 \$675 \$782	+\$58 +\$68 +\$80		52 ½"	55 ⅜"	<b>30-52.5C</b> <b>36-52.5C</b> <b>42-52.5C</b>	\$610 \$730 \$864	+\$62 +\$75 +\$88
	43 ½"	46 ⅜"	<b>30-43.5C</b> <b>36-43.5C</b> <b>42-43.5C</b>	\$577 \$701 \$815	+\$59 +\$72 +\$83		54"	56 ⅞"	<b>30-54C</b> <b>36-54C</b> <b>42-54C</b>	\$617 \$736 \$867	+\$62 +\$76 +\$88
	45"	47 ⅞"	<b>30-45C</b> <b>36-45C</b> <b>42-45C</b>	\$578 \$718 \$842	+\$59 +\$74 +\$86		55 ½"	58 ⅜"	<b>30-55.5C</b> <b>36-55.5C</b> <b>42-55.5C</b>	\$618 \$742 \$876	+\$63 +\$76 +\$89

### How to order

1. Specify basic cabinet product number.
2. Specify cabinet interiors from TOP to BOTTOM.
3. Specify accessories, see Accessories section.
4. Specify finish color.
5. If lock is not required add suffix 'NL' after product number. Deduct \$63 list.

### Product code key example 30-15C

- 30** cabinet width
- 15** cabinet interior clear height
- C** Custom Profile Series

### General information

Cases in this section are basic empty units without doors, drawers or accessories. Specify cabinet components and accessories on the following pages ensuring the total height of the selected components equals the total interior clear height of the case. Cabinets are available in 42" case heights and 3" widths. Interior components are available in 3", 6", 10½", 12", 13½", 15" and 24" sizes. (Note: 3" drawers specified in a bottom opening, above a 1½" filler or above a reference shelf cannot be locked.) ⅝" glides are standard and can be used with our without base aprons. Counterweights are recommended.

**Cabinets are 18" in depth.**

### Counterweights

Counterweights are required for ALL freestanding units that are not anchored or ganged to other cabinets or bolted to walls/floor. See Counterweight matrix on page <?>.

### Finishes

Refer to Finishes section for color options.

**Note: Exterior cabinet heights shown below are nominal. Actual heights, with glides fully recessed, are ⅛" less.**

**Cabinets 64 ⅜" and over include a hidden tie bar in their construction.**

	Interior height	Exterior height	Part number	Neutral paint/ base price	Accent paint		Interior height	Exterior height	Part number	Neutral paint/ base price	Accent paint
	57"	59 ⅞"	<b>30-57C</b> <b>36-57C</b> <b>42-57C</b>	\$621 \$749 \$881	+\$63 +\$77 +\$90		67 ½"	70 ⅜"	<b>30-67.5C</b> <b>36-67.5C</b> <b>42-67.5C</b>	\$708 \$836 \$981	+\$73 +\$85 +\$99
	58 ½"	61 ⅜"	<b>30-58.5C</b> <b>36-58.5C</b> <b>42-58.5C</b>	\$622 \$750 \$882	+\$63 +\$77 +\$90		69"	71 ⅞"	<b>30-69C</b> <b>36-69C</b> <b>42-69C</b>	\$726 \$876 \$1006	+\$75 +\$89 +\$102
	60"	62 ⅞"	<b>30-60C</b> <b>36-60C</b> <b>42-60C</b>	\$627 \$751 \$883	+\$63 +\$77 +\$90		70 ½"	73 ⅜"	<b>30-70.5C</b> <b>36-70.5C</b> <b>42-70.5C</b>	\$750 \$902 \$1036	+\$77 +\$92 +\$105
	61 ½"	64 ⅜"	<b>30-61.5C</b> <b>36-61.5C</b> <b>42-61.5C</b>	\$628 \$752 \$884	+\$63 +\$77 +\$90		72"	74 ⅞"	<b>30-72C</b> <b>36-72C</b> <b>42-72C</b>	\$778 \$929 \$1059	+\$80 +\$94 +\$108
	63"	65 ⅞"	<b>30-63C</b> <b>36-63C</b> <b>42-63C</b>	\$645 \$777 \$905	+\$65 +\$80 +\$92		73 ½"	76 ⅜"	<b>30-73.5C</b> <b>36-73.5C</b> <b>42-73.5C</b>	\$799 \$955 \$1096	+\$82 +\$97 +\$111
	64 ½"	67 ⅜"	<b>30-64.5C</b> <b>36-64.5C</b> <b>42-64.5C</b>	\$662 \$799 \$931	+\$67 +\$82 +\$94		75"	77 ⅞"	<b>30-75C</b> <b>36-75C</b> <b>42-75C</b>	\$832 \$986 \$1126	+\$85 +\$100 +\$114
	66"	68 ⅞"	<b>30-66C</b> <b>36-66C</b> <b>42-66C</b>	\$682 \$826 \$954	+\$70 +\$84 +\$97		76 ½"	79 ⅜"	<b>30-76.5C</b> <b>36-76.5C</b>	\$865 \$1018	+\$88 +\$103

### How to order

- Specify basic cabinet product number followed by drawer and shelf interiors with their accessories (see Accessories section) in order from TOP to BOTTOM, indicating which interior is in the top position. Interiors may be specified in almost any combination to make up the TOTAL INTERIOR HEIGHT.
- Specify finish color

### Product Code Key Example

**6FFC-36**

- 6 -opening size
- FF -drawer, no front
- C -Custom Profile Series
- 30 -width

### Options

Refer to Accessories section.

### Finishes

Refer to Finishes section for color options. Accessories, drawer bodies and shelves are finished in Eco Black.

### General Information

Drawer and shelf interiors on these pages **do not include accessories.**

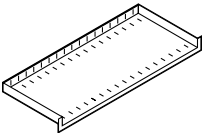
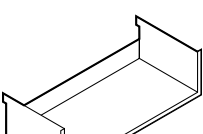
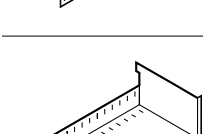
Description	Part number	Height	Depth	Weight (lbs)	Neutral paint/ base price	Accent paint
 <b>3" Opening Interiors</b> <b>3" drawer, no front</b>	<b>3FFC-30</b>	3"	30"	6	\$164	+\$18
	<b>3FFC-36</b>	3"	36"	8	\$169	+\$19
	<b>3FFC-42</b>	3"	42"	10	\$178	+\$19
 3" drawer with laminate shelf, no front	<b>3FFC/PL-30</b>	3"	30"	21	\$336	+\$36
	<b>3FFC/PL-36</b>	3"	36"	28	\$349	+\$37
	<b>3FFC/PL-42</b>	3"	42"	35	\$388	+\$40
 <b>6" Opening Interiors</b> <b>6" drawer, no front</b>	<b>6FFC-30</b>	6"	30"	7	\$178	+\$19
	<b>6FFC-36</b>	6"	36"	9	\$200	+\$22
	<b>6FFC-42</b>	6"	42"	11	\$223	+\$24
 <b>10.5" Opening Interiors</b> <b>10.5" drawer no front to accommodate suspended filing</b> <b>Note: Not to be used for bottom filing. (drawer will not accept dividers)</b>	<b>10.5FFC-30</b>	10.5"	30"	10	\$200	+\$22
	<b>10.5FFC-36</b>	10.5"	36"	13	\$228	+\$24
	<b>10.5FFC-42</b>	10.5"	42"	16	\$256	+\$27
 <b>12" Opening Interiors</b> <b>12" drawer, no front</b>	<b>12FFC-30</b>	12"	30"	11	\$200	+\$22
	<b>12FFC-36</b>	12"	36"	14	\$228	+\$24
	<b>12FFC-42</b>	12"	42"	17	\$256	+\$27
 <b>13.5" Opening Interiors</b> <b>13.5" drawer, no front</b>	<b>13.5FFC-30</b>	13.5"	30"	12	\$239	+\$25
	<b>13.5FFC-36</b>	13.5"	36"	15	\$258	+\$27
	<b>13.5FFC-42</b>	13.5"	42"	18	\$287	+\$30
 <b>15" Opening Interiors</b> <b>15" drawer, no front</b>	<b>15FFC-30</b>	15"	30"	12	\$239	+\$25
	<b>15FFC-36</b>	15"	36"	15	\$258	+\$27
	<b>15FFC-42</b>	15"	42"	18	\$287	+\$30

### How to order

- Specify basic cabinet product number followed by drawer and shelf interiors with their accessories (see Accessories section) in order from TOP to BOTTOM, indicating which interior is in the top position. Interiors may be specified in almost any combination to make up the TOTAL INTERIOR HEIGHT.
- Specify finish color

### Product Code Key Example

**25.5SS-36**

**25.5** opening size  
**SS** SuperStor™  
**36** width

### General Information



Drawer and shelf interiors on these pages **do not include accessories.**

### Options

Refer to Accessories section.

### Finishes

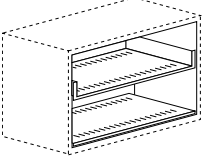
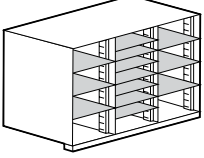
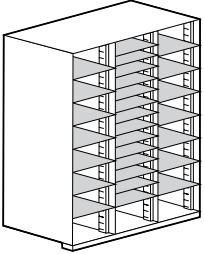
Refer to Finishes section for color options. Superstor insert and trays are finished in Onyx Black (#E013).

Description	Part number	Height	Depth	Weight (lbs)	Neutral paint/ base price	Accent paint
 <p>24" and 27" Opening Interiors 24" and 27" opening for hinged doors, 1 adjustable slotted shelf. Bottom shelf is standard with slots. Must be specified in top opening.</p>	<b>24HDC/SH-30</b>	24"	30"	20	\$465	+\$48
	<b>24HDC/SH-36</b>	24"	36"	25	\$488	+\$50
	<b>24HDC/SH-42</b>	24"	42"	30	\$522	+\$53
	<b>27HDC/SH-30</b>	27"	30"	22	\$465	+\$58
	<b>27HDC/SH-36</b>	27"	36"	27	\$488	+\$50
	<b>27HDC/SH-42</b>	27"	42"	32	\$522	+\$53
 <p>25.5" Opening Interior 25.5" SuperStor™ insert with or without hinged doors, contains 3 vertical compartments each with 22 slots at 1" increments. May be installed in cabinets with 36" or more interior. SuperStor™ insert must be specified in the top opening of your build-up. Order trays separately.</p>	<b>25.5SS-36</b>	25.5"	36"	55	\$486	+\$50
 <p>51" Opening Interior 51" SuperStor™ insert with or without hinged doors, contains 3 vertical compartments each with 48" slots at 1" increments. May be installed in cabinets with 58.5" or more interior. SuperStor™ inserts must be specified in the top opening of your build-up. Order trays separately.</p>	<b>51SS-36</b>	51"	36"	110	\$769	+\$79
 <p>SuperStor™ trays Pack of 12 trays, black only</p>	<b>T12SS-BL</b>	—	10"	25	\$240	—

The following page contains technical data that enable the specifier to communicate to local fabricators, critical measurements and other details. This will ensure that custom-fabricated fronts can easily be installed either on-site or elsewhere. Please contact Client Services if additional information is required.

**Note: Choose your configuration from the available drawers shown below.**

**Note to Millwork installers:** if a standard extended lock is ordered, it will be shipped with a barrel around the lock cylinder. This should be discarded and the cylinder only fitted through the fascia. Fascia must be  $\frac{3}{4}$ " (19.05 mm) thick for use with extended lock barrel.

### Typical clearances

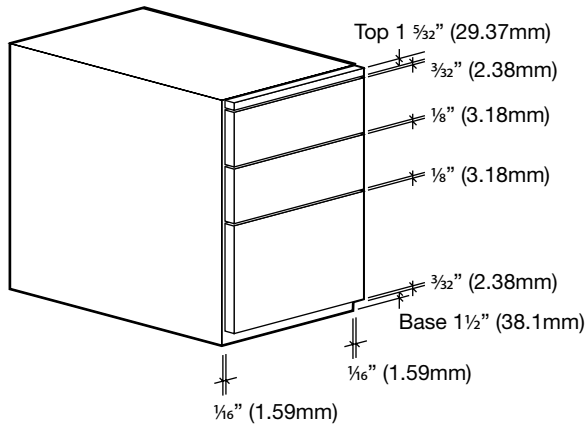

2-6" Box & 1-12" File Drawers shown above.

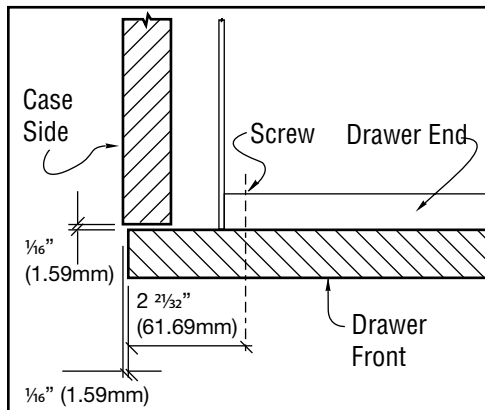

Top View of Drawer Front Mounting Detail

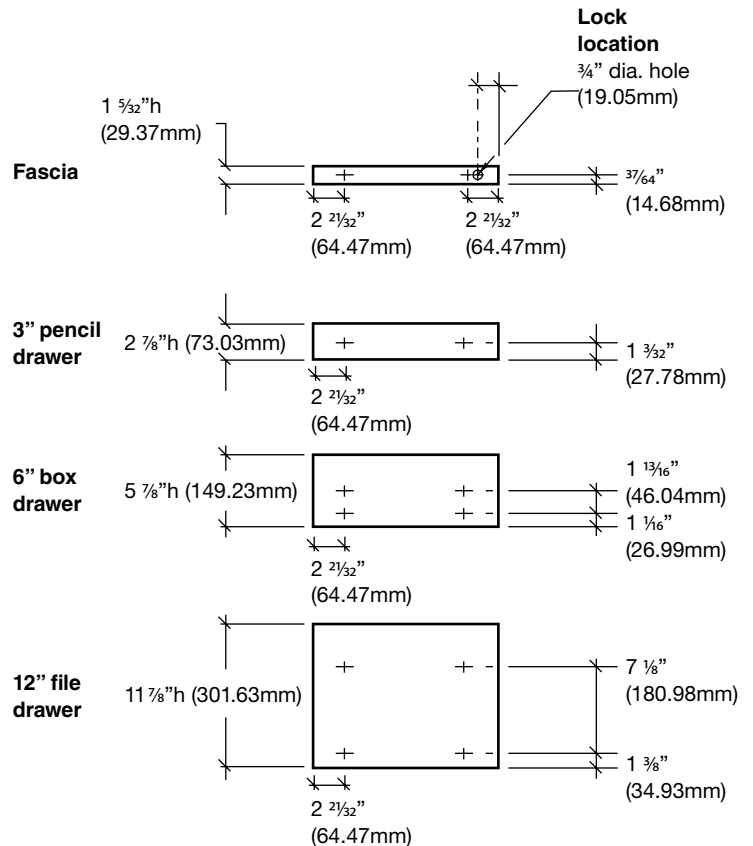

Drawer fronts must be  $\frac{3}{4}$ " (19.05mm) thick.

### Drawer Front Width

For 15" (381mm) wide pedestals, 14  $\frac{7}{8}$ " (377.83mm)  
For 18" (457mm) wide pedestals, 17  $\frac{7}{8}$ " (454.03mm)

The following pages contain technical data that enable the specifier to communicate critical measurements and other details to local fabricators. This will ensure that custom-fabricated fronts can easily be installed. Please contact Office Specialty Customer Service if additional information is required.

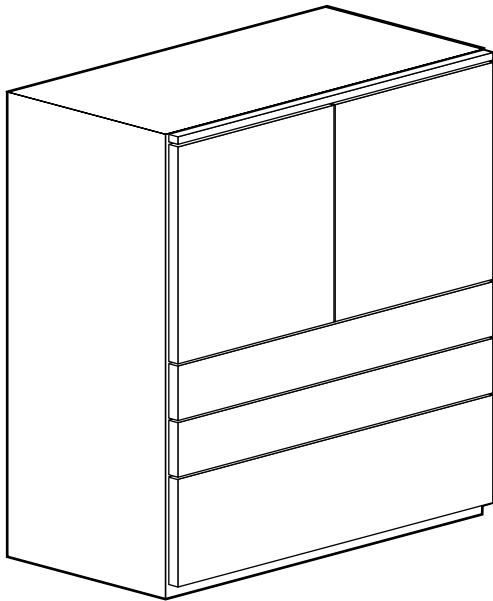

Pilot holes for No. 8 x 5/8" (15 mm) wood screw (3/32" [2 mm] dia. x 5/8" [15 mm]) to mount custom drawer front to drawer body, see detail below.

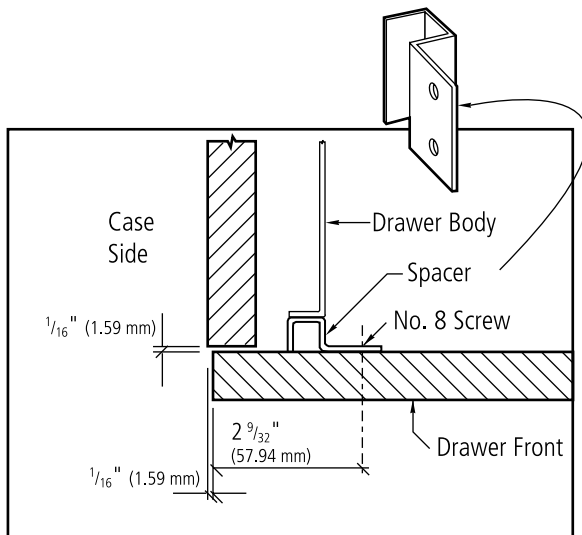

**Note to millwork installers:** if a standard extended lock is ordered, it will be shipped with a barrel around the lock cylinder. This should be discarded and the cylinder only fitted through the fascia. Fascia must be 3/4" thick for use with extended lock barrel.

Elevation of interior side of drawer fronts

**Fascia** (optional) 1 1/2" h (29 mm)

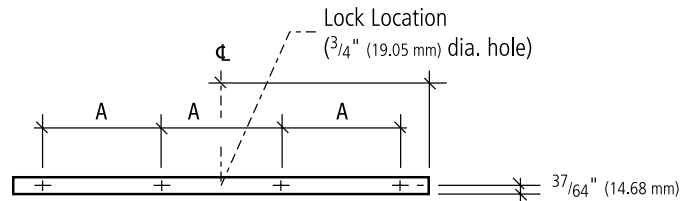

**3" (76 mm) Drawer Front** - 2 7/8" h. (73.03 mm)

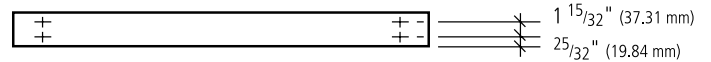

**6" (152 mm) Drawer Front** - 5 7/8" h. (149.23 mm)

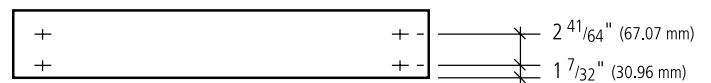

**10 1/2" (267 mm) Drawer Front** - 10 3/8" h. (263.53 mm)

**12" (305 mm) Drawer Front** - 11 7/8" h. (301.63 mm)

**13 1/2" (343 mm) Drawer Front** - 13 3/8" h. (339.73 mm)

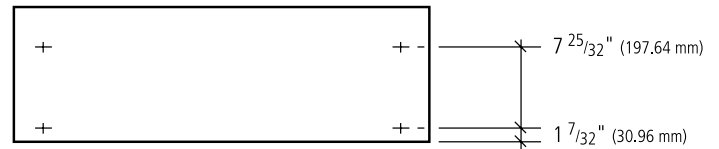

**15" (381 mm) Drawer Front** 14 7/8" h. (377.83 mm)

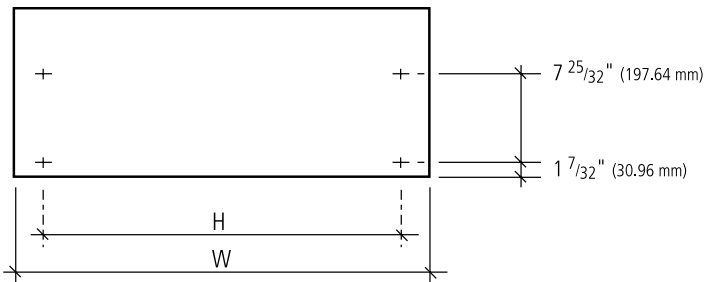

**A** For 30" (762 mm) wide cabinets is 8 7/16" (214.31 mm)  
For 36" (914 mm) wide cabinets is 10 7/16" (265.11 mm)  
For 42" (1067 mm) wide cabinets is 12 7/16" (315.91 mm)

**H** For 30" (762 mm) wide cabinets is 25 5/16" (642.93 mm)  
For 36" (914 mm) wide cabinets is 31 5/16" (795.84 mm)  
For 42" (1067 mm) wide cabinets is 37 5/16" (947.74 mm)

**W** For 30" (762 mm) wide cabinets is 29 7/8" (758.83 mm)  
For 36" (914 mm) wide cabinets is 35 7/8" (911.23 mm)  
For 42" (1067 mm) wide cabinets is 41 7/8" (1063.63 mm)

Drawer fronts 3/4" (19.05 mm) thick

Note: 24" (610 mm), 30" (762 mm), 36" (914 mm) high doors use 2 hinges each

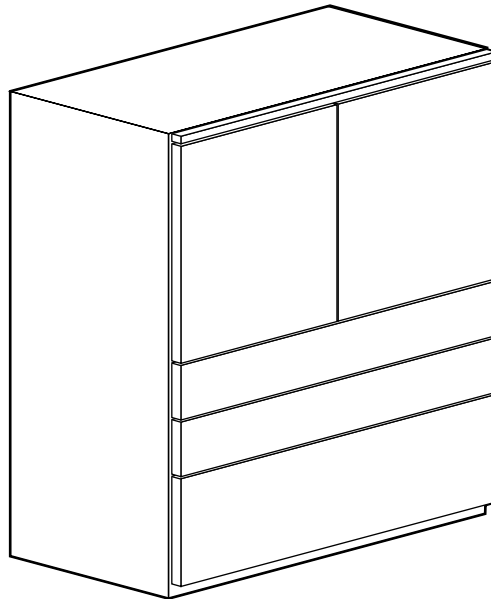

Elevation of interior side of hinged door showing hinge, latch, lock and door striker locations.

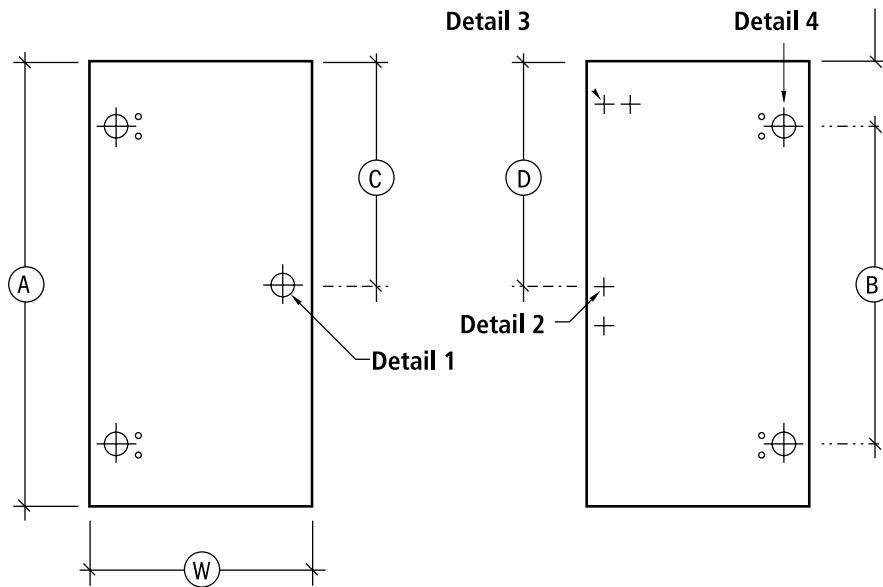

Nominal Door Height	A	B	C	D
24" (610 mm)	23 7/8" (606.43 mm)	15" (381.00 mm)	11 15/16" (303.22 mm)	11 1/16" (296.87 mm)
30" (762 mm)	29 7/8" (758.63 mm)	21" (533.40 mm)	14 15/16" (379.42 mm)	14 1/16" (373.07 mm)
36" (914 mm)	35 7/8" (911.23 mm)	27" (685.80 mm)	17 15/16" (455.62 mm)	17 1/16" (449.27 mm)

**W** For 30" (762 mm) wide cabinet, each door is 14 7/8" (377.83 mm)  
 For 36" (914 mm) wide cabinet, each door is 17 7/8" (454.03 mm)  
 For 42" (1067 mm) wide cabinet, each door is 20 7/8" (530.23 mm)

**Note:** 45" (1143 mm), 48" (1219 mm), 60" (1524 mm) high doors use 3 hinges each

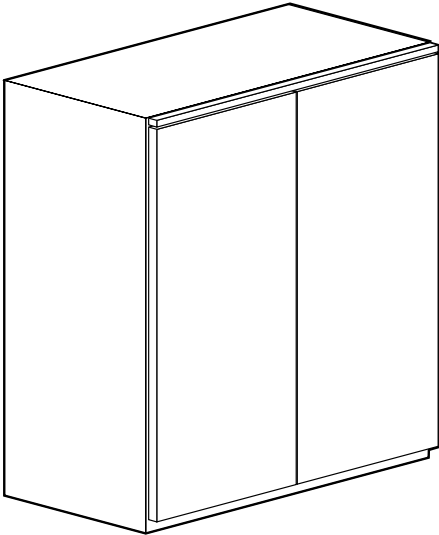

Elevation of interior side of hinged door showing hinge, latch, lock and door striker locations.

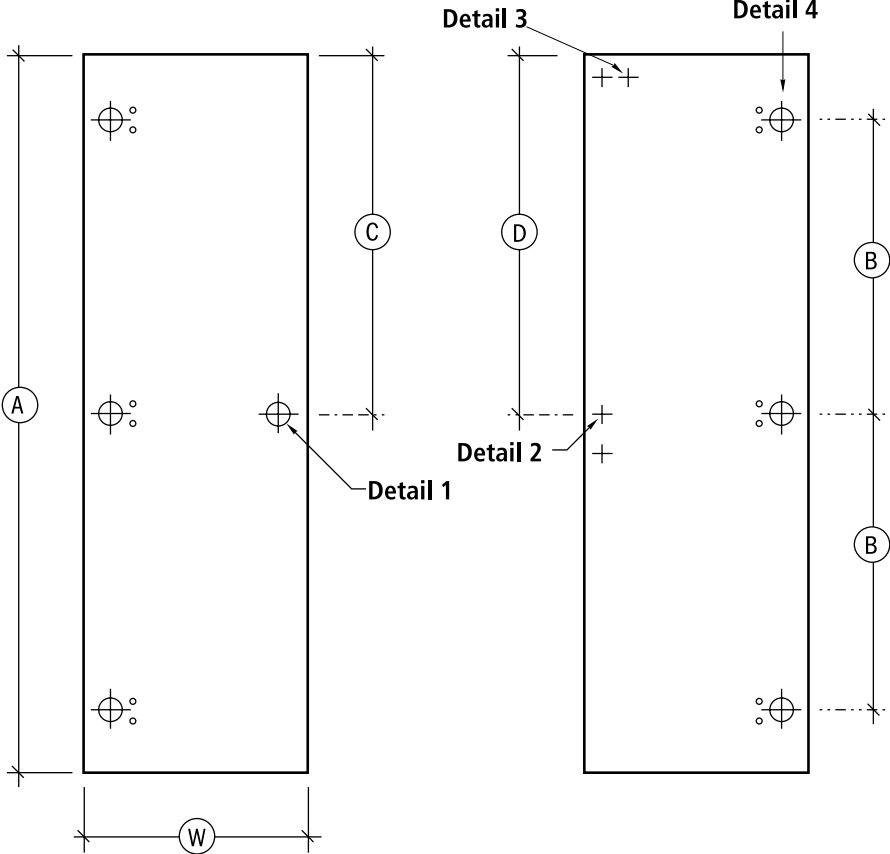

Nominal Door Height	A	B	C	D
45" (1143 mm)	44 7/8" (1139.83 mm)	18" (457.20 mm)	22 7/16" (569.92 mm)	22 3/16" (563.56 mm)
48" (1219 mm)	47 7/8" (1216.03 mm)	19 1/2" (495.30 mm)	23 15/16" (608.02 mm)	23 11/16" (601.67 mm)
60" (1524 mm)	59 7/8" (1520.83 mm)	25 1/2" (647.70 mm)	29 15/16" (760.42 mm)	29 11/16" (754.07 mm)

**W** For 30" (762 mm) wide cabinet, each door is 14 7/8" (377.83 mm)  
 For 36" (914 mm) wide cabinet, each door is 17 7/8" (454.03 mm)  
 For 42" (1067 mm) wide cabinet, each door is 20 7/8" (530.23 mm)



## Drilling Details

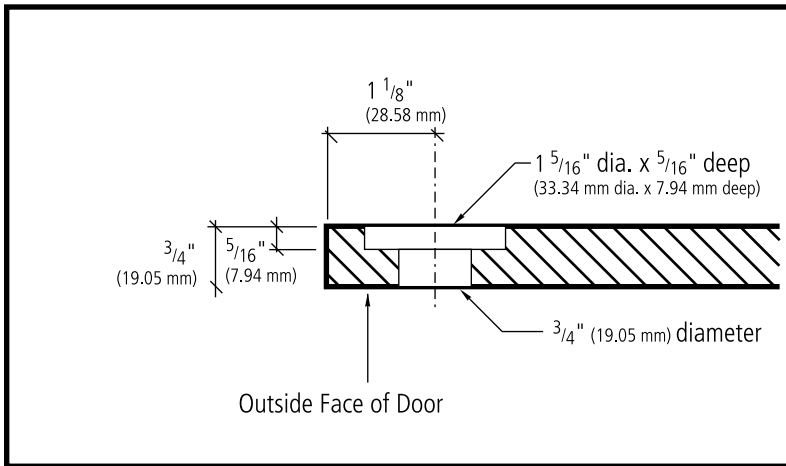

Door Lock Hole

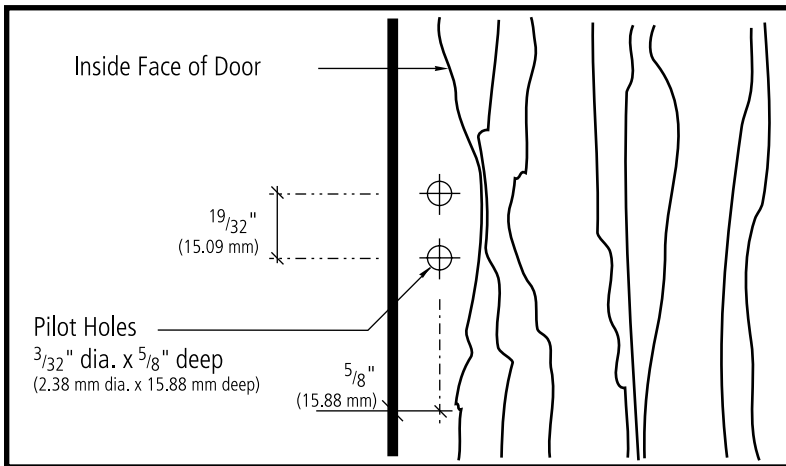

Door Striker Location

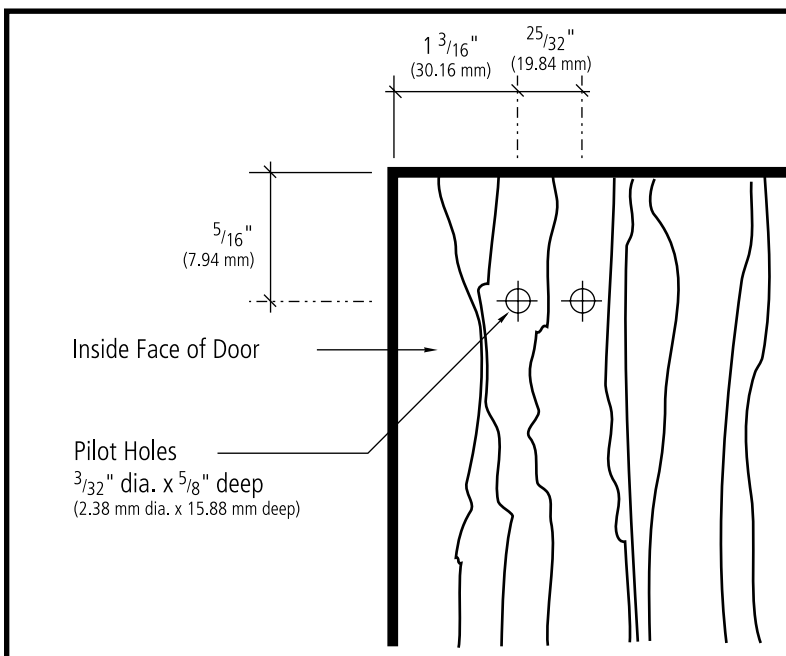

Door Latch Location

Drilling Details

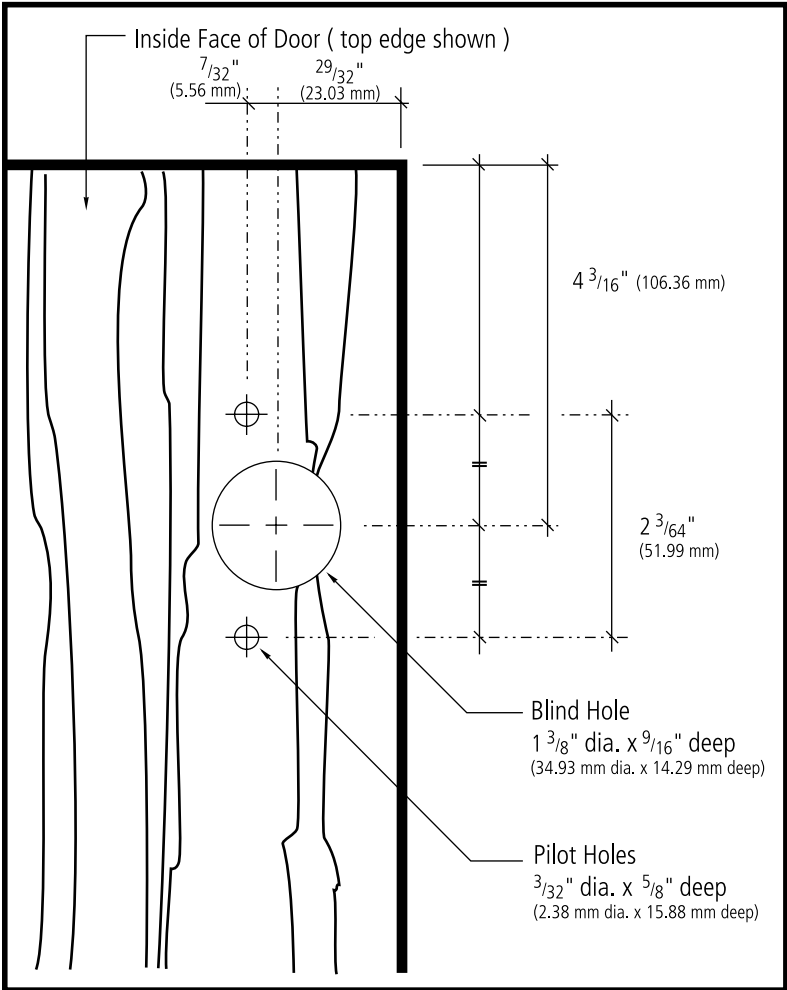

Hinge Mounting Hole

Left blank intentionally.

---

GRID



### ANSI/BIFMA

With the addition of counterweights where appropriate, Grid pedestals meet all ANSI/BIFMA specifications.

### Construction

Pedestals are welded, “wrap-around” construction using 20 gauge high quality, tension leveled, cold rolled steel.

The steel gauges selected for drawer bodies and accessories ensure the highest quality durability and performance for all components.

### Construction features & benefits

1. “Wrap-around” construction with no visible vertical seams gives a clean appearance.
2. Completely enclosed case provides rigid construction and dust-free interiors.
3. Box drawer sides are slotted on 1” centers to allow for maximum flexibility for drawer division.
4. File (12”) drawer bodies have full-height sides to accommodate hanging file folders, eliminating the need for optional file frames.
5. Fully-progressive ball bearing suspensions on all drawers, including pencil and box drawers, are staged so that left and right sides work in unison. This provides smooth drawer operation with minimum force.
6. Staged suspensions allow the drawer to be completely pulled out, providing access to the entire drawer depth.
7. Special “claw-like” device incorporated in the suspension “grips” the fixed section of the suspension arm preventing drawer bounce-back or creep when drawer is closed.
8. Casters and glides are both recessed “inboard” for a uniform exterior appearance with no visible hardware.
9. Modular interior allows for complete interchangeability of drawer types within the pedestal case. For example, two 6” box drawers may be replaced by one 12” file drawer.

### Counterweights

Counterweights are required for ALL freestanding units that are not anchored or ganged to other cabinets or bolted to walls/floor.

Counterweights come standard with ALL mobile pedestals and must be field installed.

### Drawer standard equipment

Pedestals containing 6” drawers are provided with one pencil tray per pedestal and one steel divider per drawer. 12” drawers have one suspension bar for side-to-side filing of letter or legal folders.

### Casters

4 Swivel, recessed 1½” black, double-wheel phenolic carpet casters are supplied with mobile pedestals and must be field installed. Recessed casters are not visible.

### Glides

Overall heights are inclusive of metal glides. Heights may be increased up to ⅝” by extending standard glide. Glides are accessible from inside the pedestal when the bottom drawer is fully extended or removed and may be adjusted with a ¼” socket driver.

Optional 1½” stem glides are available. Specify separately and add \$26 list to the pedestal price. Requires field installation.

For optional Platform style glide, see the Accessories section of this price list.

### Locks

Pedestals come standard with lock. For lock location, see diagram at the front of this price list.

Random keying is standard. Pedestals may be ordered keyed alike. Specify. Locks feature removable core and are standard with two keys, one of which has a black neoprene plastic key cover.

Master keys are available at \$45 list.

### Tops



Refer to Accessories Section to specify matching tops.

### Finishes

Refer to the Finish section at the front of this price list.

### Drawer Pulls

There are 5 pull options for Nuform™ and 6 for veneer fronts.

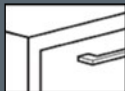
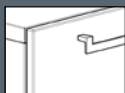
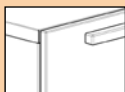
Pull	Nuform	Veneer
 <b>FP001</b> P290 Aluminum Leaf Finish		
 <b>FP002</b> Matte Chrome Finish		
 <b>FP004</b> Brushed Nickel Finish		
 <b>FP005</b> Satin Nickel Finish		
 <b>FP007</b> Brushed Nickel Finish	+\$73	+\$73
 <b>FP008</b> Matte Chrome Finish	+\$73	+\$73
 <b>FP009</b> Nickel Plated Matte Finish	+\$73	+\$73

Available    Unavailable

Pulls FP004, FP005, FP007 and FP008 meet the guidelines for ADA compliance.

**Note: FP002 is not available on hinged door cabinets.**

### How to order

1. Specify product number.
2. Specify case finish.
3. Specify front finish.
4. Specify options.

### Product code key example

**1518□-2F**

**15** cabinet width

**18** cabinet depth

□ **Q** - Nuform

**W** - veneer

**2** number of drawers

**F** 12" file drawer

**NOTE: Pricing for Drawer pull FP001 is standard. For additional pulls review pull option chart.**

### General information

Pedestals are standard with glides. Exterior pedestal heights are nominal. Actual heights (with glides fully recessed) are 1/8" less. Pedestals containing 6" drawers are standard with one pencil tray per pedestal and one steel divider per drawer. 12" drawers have one suspension bar for side-to-side filing of letter or legal size folders.

### Counterweights

Counterweights are required for ALL freestanding units that are not anchored or ganged to other cabinets or bolted to walls/floor. Counterweights are standard with all mobile pedestals and must be field installed. See Counterweight matrix on page 023.

### Accessories

See Accessories section for counterweights and accessories.

### Lock option

Pedestals come standard with lock.

### Finishes

Refer to Finishes section for finish options for case, Nuform Solid and Woodgrain fronts and veneer fronts. Drawer bodies and accessories are finished in Eco Black.

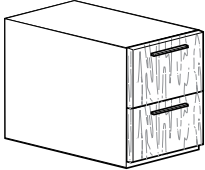
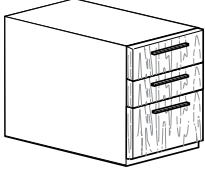
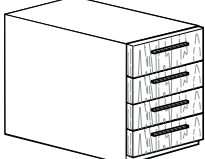
Description	Part number	Height	Width	Weight (lbs)	Nuform/ Neutral paint	Veneer/ Neutral paint	Accent paint
 2-12" file glides	<b>1518□-2F</b>	26 7/8"	15"	80	\$1050	\$1330	+\$107
	<b>1522□-2F</b>	26 7/8"	15"	90	\$1106	\$1379	+\$112
	<b>1528□-2F</b>	26 7/8"	15"	100	\$1265	\$1516	+\$127
 2-6" box, 1-12" file glides	<b>1518□-2BF</b>	26 7/8"	15"	80	\$1214	\$1564	+\$122
	<b>1522□-2BF</b>	26 7/8"	15"	90	\$1236	\$1583	+\$125
	<b>1528□-2BF</b>	26 7/8"	15"	100	\$1357	\$1687	+\$136
 4-6" box glides	<b>1518□-4B</b>	26 7/8"	15"	80	\$1172	\$1324	+\$118
	<b>1522□-4B</b>	26 7/8"	15"	90	\$1254	\$1419	+\$126
	<b>1528□-4B</b>	26 7/8"	15"	100	\$1290	\$1458	+\$130

### ANSI/BIFMA

With the addition of counterweights where appropriate, Grid lateral files meet all ANSI/BIFMA specifications.

### Construction

Lateral files and hinged door cabinets are of all-welded construction using 20 and 22 gauge high quality, tension leveled, cold rolled steel. The steel gauges selected for drawer bodies and accessories ensure the highest quality durability and performance for all components.

### Construction features & benefits

1. All interiors are modular and interchangeable so that cabinets can be retrofitted with new accessories and interiors.
2. Corners are strengthened with a reinforcing gusset and are welded at junction of top and case, eliminating horizontal lines for a cleaner, flush appearance on the face of the cabinet.
3. Fully-progressive ball bearing suspensions are staged so that left and right sides work in unison. This provides smooth drawer operation with minimum force.
4. Special "claw-like" device incorporated in suspensions "grips" the fixed section of the suspension arm preventing drawer bounce-back or creep when drawer is closed.
5. Self-closing, 110° opening, European style cupboard hinges provide smooth hinged door operation. Hinges are not visible from the exterior of the cabinet.

### Safelock™

The patented Safelock mechanism provides complete security against accidental opening of two or more drawers simultaneously.

When any drawer or shelf is extended, even fractionally, Safelock ensures that all other openings, except for the 3" drawer, immediately become inoperable. Safelock is standard on all lateral files.

### Counterweights

Counterweights are required for ALL freestanding units that are not anchored or ganged to other cabinets or bolted to walls/floor.

### Drawer standard equipment

Pullout drawers are standard with one pair hangfile bars for side-to-side suspended filing. Optional accessories are available.

### Glides

Overall heights are inclusive of metal glides. Heights may be increased up to 5/8" by extending standard glide. Standard glides may be used with or without base aprons. Glides are accessible from inside the cabinet when the bottom drawer is fully extended or removed and may be adjusted with a 1/4" socket driver.

Optional 1 1/2" stem glides are available. Specify separately and add \$26 list to the cabinet price. Requires field installation. For optional Platform glide, see Accessories section of this price list.

### Locks

Cabinets come standard with lock. For lock location, see the diagram at the front of this price list. Random keying is standard. Files may be ordered keyed alike. Specify. Locks feature removable core and are standard with two keys, one of which features a black neoprene plastic cover.

Master keys are available at \$45 list.

### Tops



Refer to Accessories Section to specify matching tops.

### Finishes

Refer to the Finishes section at the front of this price list.

### Drawer Pulls

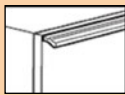
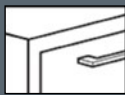
There are 5 pull options for Nuform™ and 6 for veneer fronts.

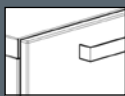
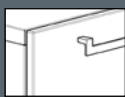
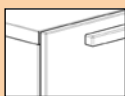
Pull	Nuform	Veneer
 <b>FP001</b> P290 Aluminum Leaf Finish		
 <b>FP002</b> Matte Chrome Finish		
 <b>FP004</b> Brushed Nickel Finish		
 <b>FP005</b> Satin Nickel Finish		
 <b>FP007</b> Brushed Nickel Finish	+\$73	+\$73
 <b>FP008</b> Matte Chrome Finish	+\$73	+\$73
 <b>FP009</b> Nickel Plated Matte Finish	+\$73	+\$73

Available      Unavailable

Pulls FP004, FP005, FP007 and FP008 meet the guidelines for ADA compliance.

**Note: FP002 is not available on hinged door cabinets.**

**How to order**

1. Specify product number.
2. Specify case finish.
3. Specify front finish.
4. Specify options.

**Product code key example**

**36-2FF**□

**36** cabinet width  
**2** number of drawers  
**FF** fixed front drawers

□ **Q** - Nuform  
**W** - veneer

**NOTE: Pricing for Drawer pull FP001 is standard. For additional pulls review pull option chart.**

**General information**

Exterior cabinet heights are nominal. Actual heights (with glides fully recessed) are 1/8" less. Cabinets are priced inclusive of 1 pair of hangfile bars in each pullout opening. Shelves are adjustable except the shelf above the file drawers. All shelves are slotted to accept dividers. Shelf dividers are not included. See Accessories section.

**Counterweights**

Counterweights are required for ALL freestanding units that are not anchored or ganged to other cabinets or bolted to walls/floor. See Counterweight matrix on page 023.

**Accessories**

See Accessories section for counterweights and accessories.

**Lock option**

Cabinets come standard with lock.

**Finishes**

Refer to Finishes section for finish options for case, Nuform Solid and Woodgrain fronts and veneer fronts. Drawer bodies and accessories are finished in Eco Black.

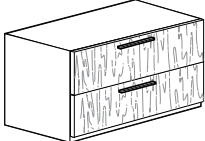
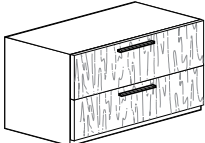
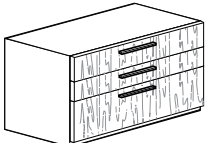
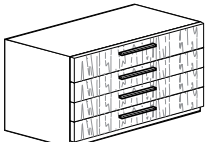
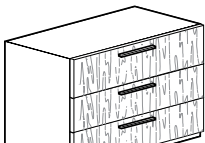
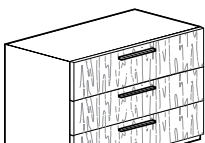
Description	Part number	Height	Width	Weight (lbs)	Nuform/ Neutral paint	Veneer/ Neutral paint	Accent paint
	<b>2 high cabinet</b>	23 7/8"	30"	80	\$1368	\$1812	+\$137
	<b>2-10.5" fixed front drawers.</b>	<b>30-21-2FF</b> □	<b>36-21-2FF</b> □	100	\$1446	\$1861	+\$147
		<b>42-21-2FF</b> □	23 7/8"	42"	120	\$1482	\$1894
	<b>2 high cabinet</b>	26 7/8"	30"	100	\$1323	\$1861	+\$133
	<b>2-12" fixed front drawers</b>	<b>30-2FF</b> □	<b>36-2FF</b> □	120	\$1422	\$1927	+\$144
		<b>42-2FF</b> □	26 7/8"	42"	130	\$1473	\$1962
	<b>2 high cabinet</b>	26 7/8"	30"	105	\$1593	\$2289	+\$161
	<b>top 2 openings 6" drawers,</b>	<b>30-2BF</b> □	<b>36-2BF</b> □	125	\$1700	\$2400	+\$171
	<b>bottom opening 12" drawer.</b>	<b>42-2BF</b> □	26 7/8"	42"	135	\$1775	\$2487
	<b>2 high cabinet</b>	26 7/8"	30"	105	\$1818	\$2739	+\$183
	<b>4-6" drawers.</b>	<b>30-4B</b> □	<b>36-4B</b> □	125	\$1971	\$2898	+\$198
		<b>42-4B</b> □	26 7/8"	42"	135	\$2049	\$3027
	<b>3 high cabinet</b>	34 3/8"	30"	120	\$1787	\$2487	+\$180
	<b>3-10.5" fixed front drawers</b>	<b>30-31.5-3FF</b> □	<b>36-31.5-3FF</b> □	140	\$1866	\$2543	+\$188
		<b>42-31.5-3FF</b> □	34 3/8"	42"	160	\$1944	\$2597
	<b>3 high cabinet</b>	38 7/8"	30"	120	\$1744	\$2423	+\$176
	<b>3-12" fixed front drawers</b>	<b>30-3FF</b> □	<b>36-3FF</b> □	140	\$1876	\$2617	+\$189
		<b>42-3FF</b> □	38 7/8"	42"	160	\$1959	\$2768



## Laterals

### How to order

1. Specify product number.
2. Specify case finish.
3. Specify front finish.
4. Specify options.

### Product code key example

**36-3FF**□

- 36** cabinet width  
**3** number of drawers  
**FF** fixed front drawers  
 **Q** - Nuform  
 **W** - veneer

**NOTE: Pricing for Drawer pull FP001 is standard. For additional pulls review pull option chart.**

### General information

Exterior cabinet heights are nominal. Actual heights (with glides fully recessed) are 1/8" less. Cabinets are priced inclusive of 1 pair of hangfile bars in each pullout opening. Shelves are adjustable except the shelf above the file drawers. All shelves are slotted to accept dividers. Shelf dividers are not included. See Accessories section.

### Counterweights

Counterweights are required for ALL freestanding units that are not anchored or ganged to other cabinets or bolted to walls/floor. See Counterweight matrix on page 023.

### Accessories

See Accessories section for counterweights and accessories.

### Lock option

Cabinets come standard with lock.

### Finishes

Refer to Finishes section for finish options for case, Nuform Solid and Woodgrain fronts and veneer fronts. Drawer bodies and accessories are finished in Eco Black.

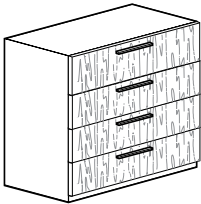
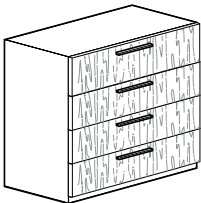
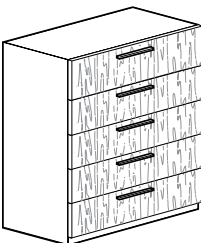
Description	Part number	Height	Width	Weight (lbs)	Nuform/ Neutral paint	Veneer/ Neutral paint	Accent paint
 <p><b>4 high cabinet</b> <b>4-10.5" fixed front drawers</b></p>	<b>30-42-4FF</b> □	44 7/8"	30"	140	\$2226	\$3182	+\$224
	<b>36-42-4FF</b> □	44 7/8"	36"	160	\$2323	\$3243	+\$234
	<b>42-42-4FF</b> □	44 7/8"	42"	180	\$2422	\$3317	+\$244
 <p><b>4 high cabinet</b> <b>4-12" fixed front drawers</b></p>	<b>30-4FF</b> □	50 7/8"	30"	140	\$2234	\$3327	+\$225
	<b>36-4FF</b> □	50 7/8"	36"	160	\$2331	\$3446	+\$234
	<b>42-4FF</b> □	50 7/8"	42"	180	\$2423	\$3513	+\$244
 <p><b>5 high cabinet</b> <b>5-10.5" fixed front drawers</b></p>	<b>30-52.5-5FF</b> □	55 3/8"	30"	180	\$2619	\$3831	+\$263
	<b>36-52.5-5FF</b> □	55 3/8"	36"	205	\$2750	\$3920	+\$276
	<b>42-52.5-5FF</b> □	55 3/8"	42"	240	\$2858	\$4000	+\$288

## How to order

1. Specify product number.
2. Specify case finish.
3. Specify front finish.
4. Specify options.

## Product code key example

**3624HD**□-SH

**36** cabinet width  
**24** interior height  
**HD** hinged door

□ **Q** - Nuform  
**W** - veneer

**SH** shelf

**NOTE: Pricing for Drawer pull FP001 is standard. For additional pulls review pull option chart.**

## General information

Exterior cabinet heights are nominal. Actual heights (with glides fully recessed) are 1/8" less. Hinged doors are standard with self-closing European style hinges that open 110°. Shelves are slotted every 1 1/2" and are height adjustable in 1 1/2" increments. Shelf dividers are not included. See Accessories section.

**FP002 is not available on hinged door cabinets.**

## Accessories

See Accessories section for counterweights and accessories.

## Lock option

Cabinets come standard with lock.

## Finishes

Refer to Finishes section for finish options for case, Nuform Solid and Woodgrain fronts and veneer fronts. Drawer bodies and accessories are finished in Eco Black.

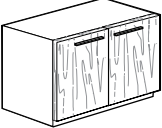
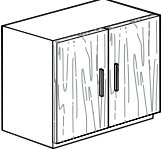
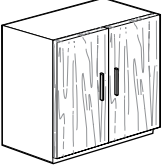
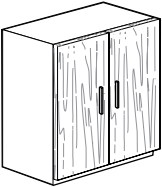
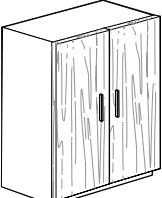
Description	Part number	Height	Width	Weight (lbs)	Nuform/ Neutral paint	Veneer/ Neutral paint	Accent paint
	<b>3024HD</b> □	26 7/8"	30"	75	\$995	\$1127	+\$101
	<b>3624HD</b> □	26 7/8"	36"	95	\$1076	\$1215	+\$109
	<b>4224HD</b> □	26 7/8"	42"	110	\$1220	\$1381	+\$123
Cabinet with hinged doors with 1 slotted shelf	<b>3024HD</b> □-SH	26 7/8"	30"	85	\$1084	\$1212	+\$110
	<b>3624HD</b> □-SH	26 7/8"	36"	105	\$1167	\$1301	+\$118
	<b>4224HD</b> □-SH	26 7/8"	42"	115	\$1301	\$1467	+\$131
	<b>3031.5HD</b> □	34 3/8"	30"	85	\$1096	\$1242	+\$111
	<b>3631.5HD</b> □	34 3/8"	36"	105	\$1182	\$1337	+\$119
	<b>4231.5HD</b> □	34 3/8"	42"	120	\$1350	\$1523	+\$135
Cabinet with hinged doors with 1 slotted shelf	<b>3031.5HD</b> □-SH	34 3/8"	30"	95	\$1189	\$1328	+\$120
	<b>3631.5HD</b> □-SH	34 3/8"	36"	115	\$1273	\$1422	+\$128
	<b>4231.5HD</b> □-SH	34 3/8"	42"	125	\$1438	\$1611	+\$146
	<b>3036HD</b> □	38 7/8"	30"	130	\$1135	\$1284	+\$115
	<b>3636HD</b> □	38 7/8"	36"	140	\$1217	\$1378	+\$123
	<b>4236HD</b> □	38 7/8"	42"	150	\$1389	\$1567	+\$140
Cabinet with hinged doors with 2 slotted shelves	<b>3036HD</b> □-SH	38 7/8"	30"	140	\$1315	\$1458	+\$132
	<b>3636HD</b> □-SH	38 7/8"	36"	150	\$1400	\$1554	+\$142
	<b>4236HD</b> □-SH	38 7/8"	42"	155	\$1568	\$1742	+\$158
	<b>3042HD</b> □	44 7/8"	30"	140	\$1248	\$1411	+\$126
	<b>3642HD</b> □	44 7/8"	36"	150	\$1369	\$1553	+\$137
	<b>4242HD</b> □	44 7/8"	42"	160	\$1568	\$1774	+\$158
Cabinet with hinged doors with 2 slotted shelves	<b>3042HD</b> □-SH	44 7/8"	30"	150	\$1427	\$1584	+\$145
	<b>3642HD</b> □-SH	44 7/8"	36"	160	\$1553	\$1724	+\$157
	<b>4242HD</b> □-SH	44 7/8"	42"	170	\$1749	\$1946	+\$177
	<b>3048HD</b> □	50 7/8"	30"	160	\$1275	\$1442	+\$128
	<b>3648HD</b> □	50 7/8"	36"	170	\$1440	\$1631	+\$146
	<b>4248HD</b> □	50 7/8"	42"	190	\$1650	\$1866	+\$166
Cabinet with hinged doors with 2 slotted shelves	<b>3048HD</b> □-SH	50 7/8"	30"	170	\$1455	\$1616	+\$148
	<b>3648HD</b> □-SH	50 7/8"	36"	180	\$1623	\$1803	+\$164
	<b>4248HD</b> □-SH	50 7/8"	42"	200	\$1833	\$2042	+\$185

## Storage Cabinets Solid Core Doors

### How to order

1. Specify product number.
2. Specify case finish.
3. Specify front finish.
4. Specify options.

### Product code key example

**3652.5HD**□-SH

**36** cabinet width  
**52.5** interior height  
**HD** hinged door

□ **Q** - Nuform  
**W** - veneer

**SH** shelf

**NOTE: Pricing for Drawer pull FP001 is standard. For additional pulls review pull option chart.**

### General information

Exterior cabinet heights are nominal. Actual heights (with glides fully recessed) are 1/8" less. Hinged doors are standard with self-closing European style hinges that open 110°. Shelves are slotted every 1 1/2" and are height adjustable in 1 1/2" increments. Shelf dividers are not included. See Accessories section.

**FP002 is not available on hinged door cabinets.**

### Accessories

See Accessories section for counterweights and accessories.

### Lock option

Cabinets come standard with lock.

### Finishes

Refer to Finishes section for finish options for case, Nuform Solid and Woodgrain fronts and veneer fronts. Drawer bodies and accessories are finished in Eco Black.

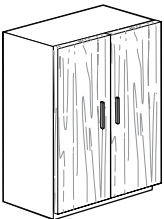
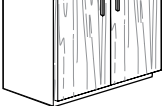
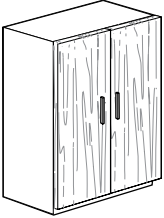
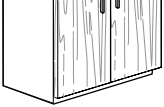
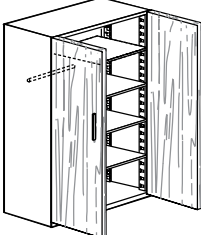
Description	Part number	Height	Width	Weight (lbs)	Nuform/ Neutral paint	Veneer/ Neutral paint	Accent paint
	<b>3052.5HD</b> □	55 3/8"	30"	160	\$1417	\$1603	+\$144
	<b>3652.5HD</b> □	55 3/8"	36"	170	\$1596	\$1806	+\$161
	<b>4252.5HD</b> □	55 3/8"	42"	190	\$1851	\$2093	+\$186
	<b>3052.5HD</b> □-SH	55 3/8"	30"	170	\$1596	\$1776	+\$161
	<b>3652.5HD</b> □-SH	55 3/8"	36"	180	\$1779	\$1982	+\$180
	<b>4252.5HD</b> □-SH	55 3/8"	42"	200	\$2033	\$2266	+\$204
	<b>3060HD</b> □	62 7/8"	30"	170	\$1479	\$1672	+\$150
	<b>3660HD</b> □	62 7/8"	36"	185	\$1705	\$1930	+\$171
	<b>4260HD</b> □	62 7/8"	42"	210	\$1962	\$2218	+\$197
	<b>3060HD</b> □-SH	62 7/8"	30"	158	\$1750	\$1935	+\$177
	<b>3660HD</b> □-SH	62 7/8"	36"	210	\$1977	\$2189	+\$198
	<b>4260HD</b> □-SH	62 7/8"	42"	230	\$2233	\$2479	+\$225
	<b>3060HD</b> □-WS	62 7/8"	30"	185	\$1811	\$1993	+\$183
	<b>3660HD</b> □-WS	62 7/8"	36"	210	\$2039	\$2249	+\$204
	<b>4260HD</b> □-WS	62 7/8"	42"	230	\$2295	\$2540	+\$231

### How to order

1. Specify product number.
2. Specify case finish.
3. Specify front finish.
4. Specify options.

### Product code key example

**3672HD**□-SH

**36** cabinet width  
**72** interior height  
**HD** hinged door

□ **Q** - Nuform  
**W** - veneer

**SH** shelf

**NOTE: Pricing for Drawer pull FP001 is standard. For additional pulls review pull option chart.**

### General information

Exterior cabinet heights are nominal. Actual heights (with glides fully recessed) are 1/8" less. Hinged doors are standard with self-closing European style hinges that open 110°. Shelves are slotted every 1 1/2" and are height adjustable in 1 1/2" increments. Shelf dividers are not included. See Accessories section.

**FP002 is not available on hinged door cabinets.**

### Accessories

See Accessories section for counterweights and accessories.

### Lock option

Cabinets come standard with lock.

### Finishes

Refer to Finishes section for finish options for case, Nuform Solid and Woodgrain fronts and veneer fronts. Drawer bodies and accessories are finished in Eco Black.

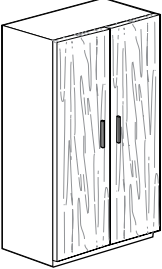
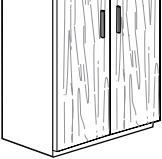
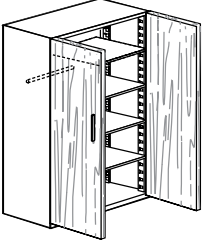
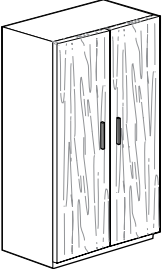
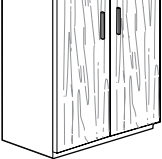
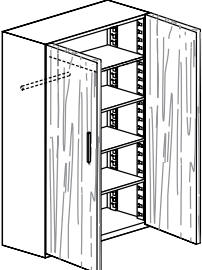
Description	Part number	Height	Width	Weight (lbs)	Nuform/ Neutral paint	Veneer/ Neutral paint	Accent paint
	<b>3072HD</b> □	74 7/8"	30"	190	\$1793	\$2027	+\$181
	<b>3672HD</b> □	74 7/8"	36"	220	\$1987	\$2248	+\$199
	<b>4272HD</b> □	74 7/8"	42"	240	\$2173	\$2454	+\$219
	<b>3072HD</b> □-SH	74 7/8"	30"	210	\$2154	\$2376	+\$217
	<b>3672HD</b> □-SH	74 7/8"	36"	240	\$2349	\$2595	+\$236
	<b>4272HD</b> □-SH	74 7/8"	42"	260	\$2534	\$2804	+\$255
	<b>3072HD</b> □-WS	74 7/8"	30"	210	\$2126	\$2349	+\$215
	<b>3672HD</b> □-WS	74 7/8"	36"	240	\$2320	\$2567	+\$233
	<b>4272HD</b> □-WS	74 7/8"	42"	260	\$2502	\$2776	+\$252
	<b>3073.5HD</b> □	76 3/8"	30"	190	\$1864	\$2110	+\$188
	<b>3673.5HD</b> □	76 3/8"	36"	220	\$2067	\$2336	+\$208
	<b>4273.5HD</b> □	76 3/8"	42"	240	\$2257	\$2553	+\$227
	<b>3073.5HD</b> □-SH	76 3/8"	30"	210	\$2225	\$2459	+\$224
	<b>3673.5HD</b> □-SH	76 3/8"	36"	240	\$2428	\$2685	+\$245
	<b>4273.5HD</b> □-SH	76 3/8"	42"	260	\$2620	\$2902	+\$263
	<b>3073.5HD</b> □-WS	76 3/8"	30"	210	\$2199	\$2429	+\$222
	<b>3673.5HD</b> □-WS	76 3/8"	36"	240	\$2399	\$2657	+\$242
	<b>4273.5HD</b> □-WS	76 3/8"	42"	260	\$2593	\$2874	+\$260

## Storage Cabinets Glazed Doors

### How to order

1. Specify product number.
2. Specify case finish.
3. Specify front finish.
4. Specify options.

### Product code key example

**3624HD-SH**

**36** cabinet width  
**24** interior height  
**HD** hinged door  
**J** glazed  
**SH** shelf

**NOTE: Pricing for Drawer pull FP001 is standard. For additional pulls review pull option chart.**

### General information

Exterior cabinet heights are nominal. Actual heights (with glides fully recessed) are  $\frac{1}{8}$ " less. Hinged doors are standard with self-closing European style hinges that open 110°. Shelves are slotted every 1  $\frac{1}{2}$ " and are height adjustable in 1  $\frac{1}{2}$ " increments. Shelf dividers are not included. See Accessories section.

**FP002 is not available on hinged door cabinets.**

### Accessories

See Accessories section for counterweights and accessories.

### Lock option

**Glazed doors do not lock.**

### Finishes

Refer to Finishes section for finish options for case. Drawer bodies and accessories are finished in Eco Black.

Glazed doors have a standard aluminum finish frame. This frame is not available in other colors. Glazing is sheer frosted acrylic that mounts in front of frame.

Slotted shelves are painted to match the case color.

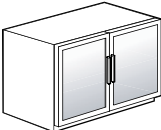
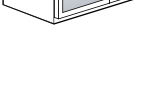
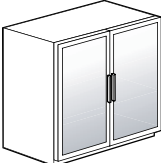
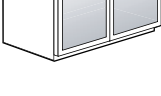
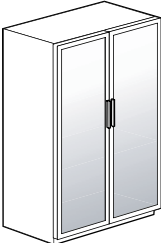
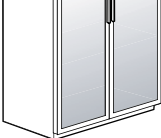
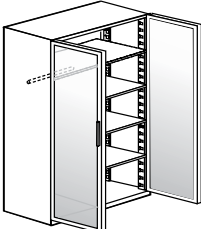
Description	Part number	Exterior height	Width	Weight (lbs)	Glazed/ Neutral paint	Accent paint
	<b>3024HDJ</b>	26 $\frac{7}{8}$ "	30"	75	\$1392	+\$142
	<b>3624HDJ</b>	26 $\frac{7}{8}$ "	36"	95	\$1461	+\$148
	<b>4224HDJ</b>	26 $\frac{7}{8}$ "	42"	110	\$1578	+\$159
	<b>3024HDJ-SH</b>	26 $\frac{7}{8}$ "	30"	80	\$1480	+\$150
	<b>3624HDJ-SH</b>	26 $\frac{7}{8}$ "	36"	100	\$1548	+\$156
	<b>4224HDJ-SH</b>	26 $\frac{7}{8}$ "	42"	115	\$1668	+\$168
	<b>3036HDJ</b>	38 $\frac{7}{8}$ "	30"	130	\$1715	+\$173
	<b>3636HDJ</b>	38 $\frac{7}{8}$ "	36"	140	\$1808	+\$182
	<b>4236HDJ</b>	38 $\frac{7}{8}$ "	42"	150	\$1988	+\$200
	<b>3036HDJ-SH</b>	38 $\frac{7}{8}$ "	30"	140	\$1893	+\$190
	<b>3636HDJ-SH</b>	38 $\frac{7}{8}$ "	36"	150	\$1985	+\$199
	<b>4236HDJ-SH</b>	38 $\frac{7}{8}$ "	42"	160	\$2167	+\$219
	<b>3060HDJ</b>	62 $\frac{7}{8}$ "	30"	170	\$2377	+\$239
	<b>3660HDJ</b>	62 $\frac{7}{8}$ "	36"	185	\$2620	+\$263
	<b>4260HDJ</b>	62 $\frac{7}{8}$ "	42"	200	\$2892	+\$291
	<b>3060HDJ-SH</b>	62 $\frac{7}{8}$ "	30"	185	\$2642	+\$265
	<b>3660HDJ-SH</b>	62 $\frac{7}{8}$ "	36"	205	\$2886	+\$290
	<b>4260HDJ-SH</b>	62 $\frac{7}{8}$ "	36"	220	\$3158	+\$317
	<b>3060HDJ-WS</b>	62 $\frac{7}{8}$ "	30"	185	\$2703	+\$271
	<b>3660HDJ-WS</b>	62 $\frac{7}{8}$ "	36"	205	\$2946	+\$296
	<b>4260HDJ-WS</b>	62 $\frac{7}{8}$ "	36"	220	\$3218	+\$323

How to order

1. Specify product number.
2. Specify case finish.
3. Specify front finish.
4. Specify options.

Product code key example

3672HD-SH

- 36 cabinet width
- 72 interior height
- HD hinged door
- J glazed
- SH shelf

**NOTE: Pricing for Drawer pull FP001 is standard. For additional pulls review pull option chart.**

General information

Exterior cabinet heights are nominal. Actual heights (with glides fully recessed) are 1/8" less. Hinged doors are standard with self-closing European style hinges that open 110°. Shelves are slotted every 1 1/2" and are height adjustable in 1 1/2" increments. Shelf dividers are not included. See Accessories section.

**FP002 is not available on hinged door cabinets.**

Accessories

See Accessories section for counterweights and accessories.

Lock option



**Glazed doors do not lock.**

Finishes

Refer to Finishes section for finish options for case. Drawer bodies and accessories are finished in Eco Black.

Glazed doors have a standard aluminum finish frame. This frame is not available in other colors. Glazing is sheer frosted acrylic that mounts in front of frame.

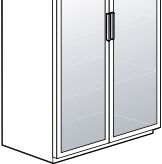
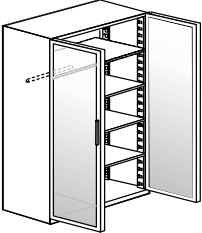
Slotted shelves are painted to match the case color.

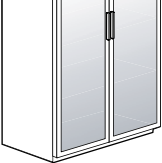
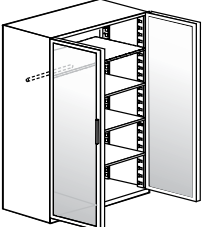
Description	Part number	Exterior height	Width	Weight (lbs)	Glazed/ Neutral paint	Accent paint
 <p>Cabinet with hinged doors, no interior accessories</p>	<b>3072HDJ</b>	74 7/8"	30"	190	\$2619	+\$263
	<b>3672HDJ</b>	74 7/8"	36"	220	\$2860	+\$288
	<b>4272HDJ</b>	74 7/8"	42"	240	\$3154	+\$317
 <p>Cabinet with hinged doors with 4 slotted shelves</p>	<b>3072HDJ-SH</b>	74 7/8"	30"	210	\$2973	+\$299
	<b>3672HDJ-SH</b>	74 7/8"	36"	240	\$3214	+\$323
	<b>4272HDJ-SH</b>	74 7/8"	42"	260	\$3508	+\$353
 <p>Cabinet with hinged doors, 1 full width blank shelf, 3 half width shelves and 1 half width coat rod Interior shelf insert painted Eco Black</p>	<b>3072HDJ-WS</b>	74 7/8"	30"	210	\$2945	+\$296
	<b>3672HDJ-WS</b>	74 7/8"	36"	240	\$3185	+\$320
	<b>4272HDJ-WS</b>	74 7/8"	42"	260	\$3480	+\$349
 <p>Cabinet with hinged doors, no interior accessories</p>	<b>3073.5HDJ</b>	76 3/8"	30"	190	\$2696	+\$270
	<b>3673.5HDJ</b>	76 3/8"	36"	220	\$2945	+\$296
	<b>4273.5HDJ</b>	76 3/8"	42"	240	\$3249	+\$326
 <p>Cabinet with hinged doors with 4 slotted shelves</p>	<b>3073.5HDJ-SH</b>	76 3/8"	30"	210	\$3052	+\$306
	<b>3673.5HDJ-SH</b>	76 3/8"	36"	240	\$3300	+\$331
	<b>4273.5HDJ-SH</b>	76 3/8"	42"	260	\$3602	+\$362
 <p>Cabinet with hinged doors, 1 full width blank shelf, 3 half width shelves and 1 half width coat rod Interior shelf insert painted Eco Black</p>	<b>3073.5HDJ-WS</b>	76 3/8"	30"	210	\$3025	+\$304
	<b>3673.5HDJ-WS</b>	76 3/8"	36"	240	\$3271	+\$328
	<b>4273.5HDJ-WS</b>	76 3/8"	42"	260	\$3576	+\$359

### How to order

1. Specify product number.
2. Specify case finish.
3. Specify front finish.
4. Specify options.

### Product code key example

**36-60-HD2F**□

- 36** cabinet width
- 60** interior height
- HD** hinged door
- 2** number of drawers
- F** 12" file drawer

- **Q** - Nuform
- W** - veneer

**NOTE: Pricing for Drawer pull FP001 is standard. For additional pulls review pull option chart.**

### General information

Exterior cabinet heights are nominal. Actual heights (with glides fully recessed) are 1/8" less. Cabinets are priced inclusive of 1 pair of hangfile bars in each pullout opening. Shelves are adjustable except the shelf above the file drawers. All shelves are slotted to accept dividers. Shelf dividers are not included.

Hinged doors are standard with self-closing European style hinges that open 110°. Shelves are slotted every 1 1/2" and are height adjustable in 1 1/2" increments. Shelf dividers are not included. See Accessories section.

**FP002 is not available on hinged door cabinets.**

### Counterweights

Counterweights are required for ALL freestanding units that are not anchored or ganged to other cabinets or bolted to walls/floor. See Counterweight matrix on page 023.

### Accessories

See Accessories section for counterweights and accessories.

### Lock option

Cabinets come standard with lock.

### Finishes

Refer to Finishes section for finish options for case, Nuform Solid and Woodgrain fronts and veneer fronts. Drawer bodies and accessories are finished in Eco Black.

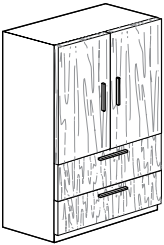
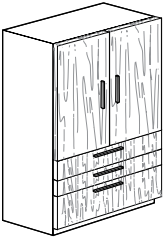
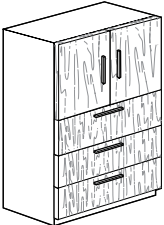
Description	Part number	Height	Width	Weight (lbs)	Nuform/ Neutral paint	Veneer/ Neutral paint	Accent paint	
	Cabinet with top opening 36" hinged door cupboard insert with 2 adjustable slotted shelves and 2-12" fixed front drawers	<b>30-60-HD2F</b> □	62 7/8"	30"	195	\$2575	\$3471	+\$259
		<b>36-60-HD2F</b> □	62 7/8"	36"	230	\$2799	\$3617	+\$282
		<b>42-60-HD2F</b> □	62 7/8"	42"	260	\$3036	\$3839	+\$305
	Cabinet with top opening 36" hinged door cupboard insert with 2 adjustable slotted shelves, 2-6" fixed front and 1-12" fixed front drawer	<b>30-60-HD2BF</b> □	62 7/8"	30"	195	\$2716	\$4026	+\$272
		<b>36-60-HD2BF</b> □	62 7/8"	36"	230	\$2916	\$4069	+\$293
		<b>42-60-HD2BF</b> □	62 7/8"	42"	260	\$3174	\$4350	+\$319
	Cabinet with top opening 24" hinged door cupboard insert with 1 adjustable slotted shelf, other 3 openings 12" fixed front drawers	<b>30-60-HD3F</b> □	62 7/8"	30"	195	\$2692	\$3993	+\$270
		<b>36-60-HD3F</b> □	62 7/8"	36"	230	\$2916	\$4184	+\$293
		<b>42-60-HD3F</b> □	62 7/8"	42"	260	\$3153	\$4448	+\$317



## How to order

1. Specify product number.
2. Specify case finish.
3. Specify front finish.
4. Specify options.

## Product code key example

**36-72-HD2F**□

**36** cabinet width  
**72** interior height  
**HD** hinged door  
**2** number of drawers  
**F** 12" file drawer

□ **Q** - Nuform  
**W** - veneer

**NOTE: Pricing for Drawer pull FP001 is standard. For additional pulls review pull option chart.**

## General information

Exterior cabinet heights are nominal. Actual heights (with glides fully recessed) are 1/8" less. Cabinets are priced inclusive of 1 pair of hangfile bars in each pullout opening. Shelves are adjustable except the shelf above the file drawers. All shelves are slotted to accept dividers. Shelf dividers are not included.

Hinged doors are standard with self-closing European style hinges that open 110°. Shelves are slotted every 1 1/2" and are height adjustable in 1 1/2" increments. Shelf dividers are not included. See Accessories section.

**FP002 is not available on hinged door cabinets.**

## Counterweights

Counterweights are required for ALL freestanding units that are not anchored or ganged to other cabinets or bolted to walls/floor. See Counterweight matrix on page 023.

## Accessories



See Accessories section for counterweights and accessories.

## Lock option

Cabinets come standard with lock.

## Finishes

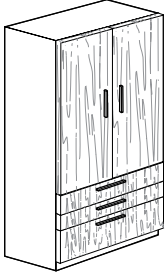
Refer to Finishes section for finish options for case, Nuform Solid and Woodgrain fronts and veneer fronts. Drawer bodies and accessories are finished in Eco Black.

Description	Part number	Height	Width	Weight (lbs)	Nuform/ Neutral paint	Veneer/ Neutral paint	Accent paint
 <p>Cabinet with top opening 48" hinged door cupboard insert with 2 adjustable slotted shelves and 2-12" fixed front drawers</p>	<b>30-72-HD2F</b> □	74 7/8"	30"	250	\$2706	\$3645	+\$271
	<b>36-72-HD2F</b> □	74 7/8"	36"	270	\$2940	\$3799	+\$296
	<b>42-72-HD2F</b> □	74 7/8"	42"	291	\$3189	\$4031	+\$320
 <p>Cabinet with top opening 48" hinged door cupboard insert with 2 adjustable slotted shelves, 2-6" fixed front and 1-12" fixed front drawer</p>	<b>30-72-HD2BF</b> □	74 7/8"	30"	250	\$2851	\$4088	+\$287
	<b>36-72-HD2BF</b> □	74 7/8"	36"	270	\$3063	\$4272	+\$307
	<b>42-72-HD2BF</b> □	74 7/8"	42"	291	\$3334	\$4568	+\$334
 <p>Cabinet with top opening 36" hinged door cupboard insert with 2 adjustable slotted shelves, 3-12" fixed front drawers</p>	<b>30-72-HD3F</b> □	74 7/8"	30"	250	\$2829	\$4193	+\$285
	<b>36-72-HD3F</b> □	74 7/8"	36"	270	\$3063	\$4391	+\$307
	<b>42-72-HD3F</b> □	74 7/8"	42"	291	\$3312	\$4672	+\$332



#### How to order

1. Specify product number.
2. Specify case finish.
3. Specify front finish.
4. Specify options.

#### Product code key example

**36-73.5-HD2F**□

- 36** cabinet width
- 73.5** interior height
- HD** hinged door
- 2** number of drawers
- F** 12" file drawer
- **Q** - Nuform
- **W** - veneer

**NOTE: Pricing for Drawer pull FP001 is standard. For additional pulls review pull option chart.**

#### General information

Exterior cabinet heights are nominal. Actual heights (with glides fully recessed) are 1/8" less. Cabinets are priced inclusive of 1 pair of hangfile bars in each pullout opening. Shelves are adjustable except the shelf above the file drawers. All shelves are slotted to accept dividers. Shelf dividers are not included.

Hinged doors are standard with self-closing European style hinges that open 110°. Shelves are slotted every 1 1/2" and are height adjustable in 1 1/2" increments. Shelf dividers are not included. See Accessories section.

**FP002 is not available on hinged door cabinets.**

#### Counterweights

Counterweights are required for ALL freestanding units that are not anchored or ganged to other cabinets or bolted to walls/floor. See Counterweight matrix on page 023.

#### Accessories



See Accessories section for counterweights and accessories.

#### Lock option

Cabinets come standard with lock.

#### Finishes

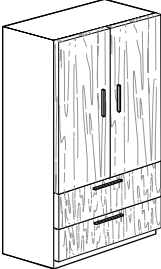
Refer to Finishes section for finish options for case, Nuform Solid and Woodgrain fronts and veneer fronts. Drawer bodies and accessories are finished in Eco Black.

Description	Part number	Height	Width	Weight (lbs)	Nuform/ Neutral paint	Veneer/ Neutral paint	Accent paint
 <p>Cabinet with top opening 49.5" hinged door cupboard insert with 2 adjustable slotted shelves and 2-12" fixed front drawers</p>	<b>30-73.5-HD2F</b> □	76 3/8"	30"	250	\$2760	\$3718	+\$277
	<b>36-73.5-HD2F</b> □	76 3/8"	36"	270	\$2997	\$3874	+\$301
	<b>42-73.5-HD2F</b> □	76 3/8"	42"	291	\$3252	\$4111	+\$326
 <p>Cabinet with top opening 49.5" hinged door cupboard insert with 2 adjustable slotted shelves, 2-6" fixed front and 1-12" fixed front drawer</p>	<b>30-73.5-HD2BF</b> □	76 3/8"	30"	250	\$2909	\$4171	+\$293
	<b>36-73.5-HD2BF</b> □	76 3/8"	36"	270	\$3122	\$4356	+\$314
	<b>42-73.5-HD2BF</b> □	76 3/8"	42"	291	\$3397	\$4658	+\$340

## How to order

1. Specify product number.
2. Specify case finish.
3. Specify front finish.
4. Specify options.

## Product code key example

**36-60-HD2FJ**□

- 36** cabinet width  
**60** interior height  
**HD** hinged door  
**2** number of drawers  
**F** 12" file drawer  
**J** glazed

- **Q** - Nuform  
**W** - veneer

**NOTE: Pricing for Drawer pull FP001 is standard. For additional pulls review pull option chart.**

## General information

Exterior cabinet heights are nominal. Actual heights (with glides fully recessed) are 1/8" less. Cabinets are priced inclusive of 1 pair of hangfile bars in each pullout opening. Shelves are adjustable except the shelf above the file drawers. All shelves are slotted to accept dividers. Shelf dividers are not included.

Hinged doors are standard with self-closing European style hinges that open 110°. Shelves are slotted every 1 1/2" and are height adjustable in 1 1/2" increments. Shelf dividers are not included. See Accessories section.

**FP002 is not available on hinged door cabinets.**

## Counterweights

Counterweights are required for ALL freestanding units that are not anchored or ganged to other cabinets or bolted to walls/floor. See Counterweight matrix on page 023.

## Accessories

See Accessories section for counterweights and accessories.

## Lock option

Cabinets come standard with lock.  
**Glazed doors do not lock.**

## Finishes

Refer to Finishes section for finish options for case, Nuform Solid and Woodgrain fronts and veneer fronts. Drawer bodies and accessories are finished in Eco Black.

Glazed doors have a standard aluminum finish frame. This frame is not available in other colors. Glazing is sheer frosted acrylic that mounts in front of frame.

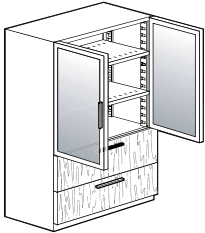
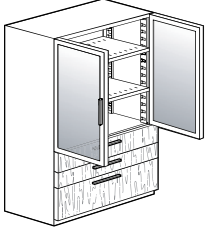
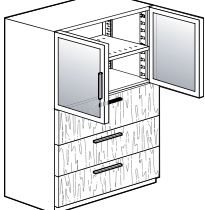
Description	Part number	Height	Width	Weight (lbs)	Nuform/ Neutral paint	Veneer/ Neutral paint	Accent paint
 <p>Cabinet with top opening 36" hinged door cupboard insert with 2 adjustable slotted shelves and 2-12" fixed front drawers</p>	<b>30-60-HD2FJ</b> □	62 7/8"	30"	195	\$3329	\$3785	+\$334
	<b>36-60-HD2FJ</b> □	62 7/8"	36"	230	\$3527	\$3990	+\$355
	<b>42-60-HD2FJ</b> □	62 7/8"	42"	260	\$3712	\$4157	+\$372
 <p>Cabinet with top opening 36" hinged door cupboard insert with 2 adjustable slotted shelves, 2-6" fixed front and 1-12" fixed front drawer</p>	<b>30-60-HD2BFJ</b> □	62 7/8"	30"	195	\$3469	\$4277	+\$348
	<b>36-60-HD2BFJ</b> □	62 7/8"	36"	230	\$3658	\$4493	+\$367
	<b>42-60-HD2BFJ</b> □	62 7/8"	42"	260	\$3851	\$4711	+\$387
 <p>Cabinet with top opening 24" hinged door cupboard insert with 1 adjustable slotted shelf, 3-12" fixed front drawers</p>	<b>30-60-HD3FJ</b> □	62 7/8"	30"	195	\$3144	\$4114	+\$316
	<b>36-60-HD3FJ</b> □	62 7/8"	36"	230	\$3303	\$4303	+\$331
	<b>42-60-HD3FJ</b> □	62 7/8"	42"	260	\$3461	\$4457	+\$347

### How to order

1. Specify product number.
2. Specify case finish.
3. Specify front finish.
4. Specify options.

### Product code key example

**36-72-HD2FJ**□

- 36** cabinet width
- 72** interior height
- HD** hinged door
- 2** number of drawers
- F** 12" file drawer
- J** glazed
- **Q** - Nuform
- **W** - veneer

**NOTE: Pricing for Drawer pull FP001 is standard. For additional pulls review pull option chart.**

### General information

Exterior cabinet heights are nominal. Actual heights (with glides fully recessed) are 1/8" less. Cabinets are priced inclusive of 1 pair of hangfile bars in each pullout opening. Shelves are adjustable except the shelf above the file drawers. All shelves are slotted to accept dividers. Shelf dividers are not included.

Hinged doors are standard with self-closing European style hinges that open 110°. Shelves are slotted every 1 1/2" and are height adjustable in 1 1/2" increments. Shelf dividers are not included. See Accessories section.

**FP002 is not available on hinged door cabinets.**

### Counterweights

Counterweights are required for ALL freestanding units that are not anchored or ganged to other cabinets or bolted to walls/floor. See Counterweight matrix on page 023.

### Accessories

See Accessories section for counterweights and accessories.

### Lock option

Cabinets come standard with lock.  
**Glazed doors do not lock.**

### Finishes

Refer to Finishes section for finish options for case, Nuform Solid and Woodgrain fronts and veneer fronts. Drawer bodies and accessories are finished in Eco Black.

Glazed doors have a standard aluminum finish frame. This frame is not available in other colors. Glazing is sheer frosted acrylic that mounts in front of frame.

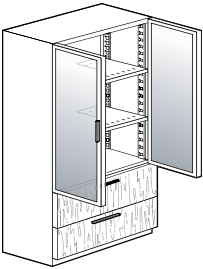
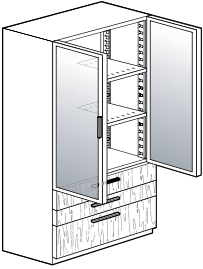
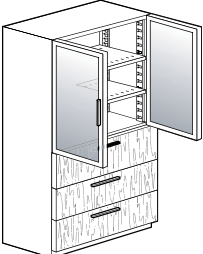
Description	Part number	Height	Width	Weight (lbs)	Nuform/ Neutral paint	Veneer/ Neutral paint	Accent paint
 <p>Cabinet with top opening 48" hinged door cupboard insert with 2 adjustable slotted shelves and 2-12" fixed front drawers</p>	<b>30-72-HD2FJ</b> □	74 7/8"	30"	250	\$3496	\$3975	+\$352
	<b>36-72-HD2FJ</b> □	74 7/8"	36"	270	\$3702	\$4190	+\$371
	<b>42-72-HD2FJ</b> □	74 7/8"	42"	291	\$3898	\$4365	+\$391
 <p>Cabinet with top opening 48" hinged door cupboard insert with 2 adjustable slotted shelves, 2-6" fixed front and 1-12" fixed front drawer</p>	<b>30-72-HD2BFJ</b> □	74 7/8"	30"	250	\$3643	\$4491	+\$366
	<b>36-72-HD2BFJ</b> □	74 7/8"	36"	270	\$3843	\$4718	+\$386
	<b>42-72-HD2BFJ</b> □	74 7/8"	42"	291	\$4041	\$4944	+\$405
 <p>Cabinet with top opening 36" hinged door cupboard insert with 2 adjustable slotted shelves, 3-12" fixed front drawers</p>	<b>30-72-HD3FJ</b> □	74 7/8"	30"	250	\$3302	\$4318	+\$331
	<b>36-72-HD3FJ</b> □	74 7/8"	36"	270	\$3466	\$4518	+\$348
	<b>42-72-HD3FJ</b> □	74 7/8"	42"	291	\$3637	\$4681	+\$365

## How to order

1. Specify product number.
2. Specify case finish.
3. Specify front finish.
4. Specify options.

## Product code key example

**36-72-HD2FJ**□

- 36** cabinet width  
**72** interior height  
**HD** hinged door  
**2** number of drawers  
**F** 12" file drawer  
**J** glazed

- **Q** - Nuform  
**W** - veneer

**NOTE: Pricing for Drawer pull FP001 is standard. For additional pulls review pull option chart.**

## General information

Exterior cabinet heights are nominal. Actual heights (with glides fully recessed) are 1/8" less. Cabinets are priced inclusive of 1 pair of hangfile bars in each pullout opening. Shelves are adjustable except the shelf above the file drawers. All shelves are slotted to accept dividers. Shelf dividers are not included.

Hinged doors are standard with self-closing European style hinges that open 110°. Shelves are slotted every 1 1/2" and are height adjustable in 1 1/2" increments. Shelf dividers are not included. See Accessories section.

**FP002 is not available on hinged door cabinets.**

## Counterweights

Counterweights are required for ALL freestanding units that are not anchored or ganged to other cabinets or bolted to walls/floor. See Counterweight matrix on page 023.

## Accessories

See Accessories section for counterweights and accessories.

## Lock option

Cabinets come standard with lock.

**Glazed doors do not lock.**

## Finishes

Refer to Finishes section for finish options for case, Nuform Solid and Woodgrain fronts and veneer fronts. Drawer bodies and accessories are finished in Eco Black.

Glazed doors have a standard aluminum finish frame. This frame is not available in other colors. Glazing is sheer frosted acrylic that mounts in front of frame.

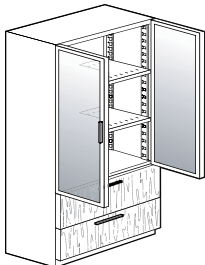
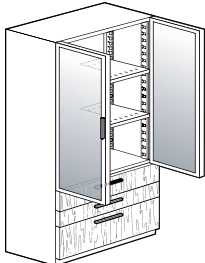
Description	Part number	Height	Width	Weight (lbs)	Nuform/ Neutral paint	Veneer/ Neutral paint	Accent paint
 <p>Cabinet with top opening 49.5" hinged door cupboard insert with 2 adjustable slotted drawers</p>	<b>30-73.5-HD2FJ</b> □	76 3/8"	30"	250	\$3566	\$4054	+\$358
	<b>36-73.5-HD2FJ</b> □	76 3/8"	36"	270	\$3775	\$4273	+\$379
	<b>42-73.5-HD2FJ</b> □	76 3/8"	42"	291	\$3973	\$4453	+\$398
 <p>Cabinet with top opening 49.5" hinged door cupboard insert with 2 adjustable slotted shelves, 2-6" fixed front and 1-12" fixed front drawer</p>	<b>30-73.5-HD2BFJ</b> □	76 3/8"	30"	250	\$3714	\$4580	+\$373
	<b>36-73.5-HD2BFJ</b> □	76 3/8"	36"	270	\$3920	\$4814	+\$393
	<b>42-73.5-HD2BFJ</b> □	76 3/8"	42"	291	\$4124	\$5043	+\$414

### Construction

Cabinets are of all-welded construction using high quality, tension leveled cold rolled steel. The steel gauges selected for drawer fronts, bodies and accessories ensure the highest quality durability and performance for all components.

### Construction features & benefits

1. All interiors are modular and interchangeable so that cabinets can be retrofitted with new accessories and interiors as required.
2. Corners are strengthened with a reinforcing gusset and are welded at junction of top and case fronts, eliminating horizontal lines for a cleaner, flush appearance on the face of the cabinet.
3. Box drawer sides are slotted on 1" centers to allow for maximum flexibility for drawer division.
4. File drawer bodies have full-height sides to accommodate hanging file folders, eliminating the need for optional file frames.
5. Front leading edge of fixed shelf is flat for easy removal of material.
6. Fully-progressive ball bearing suspensions are staged so that left and right sides work in unison. This provides smooth drawer operation with minimum force.
7. Special "claw-like" device incorporated in suspensions "grips" the fixed section of the suspension arm preventing drawer bounce-back or creep when drawer is closed.
8. Lock fingers are configured with right angle bend upward, not downward, so that lift-up doors cannot be pulled down to disengage fingers from door slots and be forced to circumvent lock system.
9. Shorter hinged door unit is equipped with one adjustable shelf, slotted on 1" centers for dividers.
10. Self-closing, 110° opening, European style cupboard hinges provide smooth hinged door operation. Hinges are not visible from the exterior of the cabinet.
11. All Towers and Lockers, with the exception of the 26 7/8" high locker, have ventilation holes in the top of the cabinet to enhance air circulation within the full height door and the shorter hinged door sections.

### Safelock™

The patented Safelock mechanism is standard on the 42" wide Locker and on Towers and Lockers that have more than one file (10 1/2" and 12") drawer. It provides complete security against accidental opening of two or more drawers simultaneously. When any drawer is extended, even fractionally,

Safelock ensures that all other openings immediately become inoperable.

### Drawer standard equipment

Lockers and Towers containing 3" or 6" drawers are provided with one pencil tray per cabinet. 6" drawers are additionally standard with one steel divider. 10 1/2", 12" and 15" letter-width file drawers have one suspension bar for side-to-side filing of letter or legal-size folders.

Full-width pullout drawers are standard with one pair hangfile bars for side-to-side suspended filing. Full-width fixed shelves are standard with 3 plate dividers. Optional accessories are available.

### Glides

Overall heights are inclusive of metal glides. Heights may be increased up to 5/8" by extending standard glide. Glides are accessible from inside the cabinet when the bottom drawer is fully extended or removed and may be adjusted with a 1/4" socket driver.

Optional 1 1/2" stem glides are available. Specify separately and add \$26 list to the cabinet price. Requires field installation.

### Locks

Towers come standard with lock. For lock location, see the front of this price list.

Random keying is standard. Files may be ordered keyed alike. Locks feature removable core and are standard with two keys, one of which has a black neoprene plastic key cover.





Master keys are available at \$45 list.

### Finishes

Refer to the Finishes section at the front of this price list.

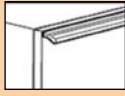
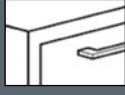
### Drawer Pulls

There are 5 pull options for Nuform™ and 6 for veneer fronts.

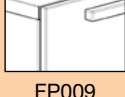
Pull	Nuform	Veneer
 <b>FP001</b> P290 Aluminum Leaf Finish		
 <b>FP002</b> Matte Chrome Finish		
 <b>FP004</b> Brushed Nickel Finish		
 <b>FP005</b> Satin Nickel Finish		
 <b>FP007</b> Brushed Nickel Finish	+\$73	+\$73
 <b>FP008</b> Matte Chrome Finish	+\$73	+\$73
 <b>FP009</b> Nickel Plated Matte Finish	+\$73	+\$73

Available

Unavailable

Pulls FP004, FP005, FP007 and FP008 meet the guidelines for ADA compliance.

**Note: FP002 is not available on hinged door cabinets.**

How to order

1. Specify product number.
2. Specify case finish.
3. Specify front finish.
4. Specify options.

Product code key example

**VL121839Q-HD**

- V** wardrobe
- L** left handed
- 12** cabinet width
- 18** nominal cabinet depth
- 39** interior height
- Q** Nuform
- HD** hinged door

**NOTE: Pricing for Drawer pull FP001 is standard. For additional pulls review pull option chart.**

General information

Exterior cabinet heights are nominal. Actual heights (with glides fully recessed) are 1/8" less.

Adding rectangular glides increases exterior height.

Hinged doors are standard with self-closing European style hinges that open 110°. Shelves are slotted every 1 1/2" and are height adjustable in 1 1/2" increments. Shelf dividers are not included. See Accessories section.

**FP002 is not available on hinged door cabinets.**

Accessories

See Accessories section for counterweights and accessories.

Lock option

Wardrobes come standard with lock.

If lock is not required add suffix 'NL' after product number. Deduct \$50 list per lock.

**Nuform Wardrobes are available with an eLock option. Add \$320 to list price for eLock.**

Finishes

Refer to Finishes section for finish options for case, Nuform Solid and Woodgrain fronts. Drawer bodies and accessories are finished in Eco Black.

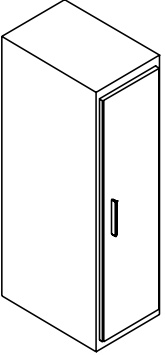
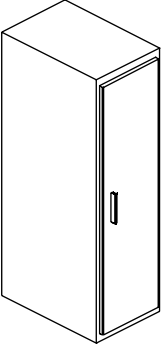
Description	Part number	Height	Width	Depth	Flat glides		Rectangular glides	Accent paint
					Coat rod + shelf/ Neutral paint	Shelves/ Neutral paint		
 <p>Nuform Wardrobe Tower to match 44" h panel eLock option available</p>	<b>VL121839Q-HD</b>	41 7/8"	12"	18"	\$1399	\$1378	+\$29	+\$142
	<b>VL122439Q-HD</b>	41 7/8"	12"	24"	\$1507	\$1485	+\$29	+\$153
	<b>VL151839Q-HD</b>	41 7/8"	15"	18"	\$1507	\$1485	+\$29	+\$153
	<b>VL152439Q-HD</b>	41 7/8"	15"	24"	\$1550	\$1526	+\$29	+\$157
	<b>VL181839Q-HD</b>	41 7/8"	18"	18"	\$1550	\$1526	+\$29	+\$157
	<b>VL182439Q-HD</b>	41 7/8"	18"	24"	\$1566	\$1399	+\$29	+\$158
	left-handed hinged door							
	<b>VR121839Q-HD</b>	41 3/8"	12"	18"	\$1399	\$1507	+\$29	+\$142
	<b>VR122439Q-HD</b>	41 3/8"	12"	24"	\$1507	\$1507	+\$29	+\$153
	<b>VR151839Q-HD</b>	41 3/8"	15"	18"	\$1507	\$1550	+\$29	+\$153
	<b>VR152439Q-HD</b>	41 3/8"	15"	24"	\$1550	\$1550	+\$29	+\$157
	<b>VR181839Q-HD</b>	41 3/8"	18"	18"	\$1550	\$1566	+\$29	+\$157
	<b>VR182439Q-HD</b>	41 3/8"	18"	24"	\$1566	\$1399	+\$29	+\$158
	right-handed hinged door (illustrated)							
 <p>Nuform Wardrobe Tower to match 51" h panel eLock option available</p>	<b>VL121846Q-HD</b>	49 3/8"	12"	18"	\$1512	\$1507	+\$29	+\$153
	<b>VL122446Q-HD</b>	49 3/8"	12"	24"	\$1594	\$1507	+\$29	+\$161
	<b>VL151846Q-HD</b>	49 3/8"	15"	18"	\$1594	\$1550	+\$29	+\$161
	<b>VL152446Q-HD</b>	49 3/8"	15"	24"	\$1681	\$1550	+\$29	+\$169
	<b>VL181846Q-HD</b>	49 3/8"	18"	18"	\$1681	\$1566	+\$29	+\$169
	<b>VL182446Q-HD</b>	49 3/8"	18"	24"	\$1774	\$1512	+\$29	+\$179
	left-handed hinged door							
	<b>VR121846Q-HD</b>	49 3/8"	12"	18"	\$1512	\$1594	+\$29	+\$153
	<b>VR122446Q-HD</b>	49 3/8"	12"	24"	\$1594	\$1594	+\$29	+\$161
	<b>VR151846Q-HD</b>	49 3/8"	15"	18"	\$1594	\$1681	+\$29	+\$161
	<b>VR152446Q-HD</b>	49 3/8"	15"	24"	\$1681	\$1681	+\$29	+\$169
	<b>VR181846Q-HD</b>	49 3/8"	18"	18"	\$1681	\$1774	+\$29	+\$169
	<b>VR182446Q-HD</b>	49 3/8"	18"	24"	\$1774	\$1512	+\$29	+\$179
	right-handed hinged door (illustrated)							

### How to order

1. Specify product number.
2. Specify case finish.
3. Specify front finish.
4. Specify options.

### Product code key example

#### VL121852Q-HD

- V** wardrobe
- L** left handed
- 12** cabinet width
- 18** nominal cabinet depth
- 52** interior height
- Q** Nuform
- HD** hinged door

**NOTE: Pricing for Drawer pull FP001 is standard. For additional pulls review pull option chart.**

### General information

Exterior cabinet heights are nominal. Actual heights (with glides fully recessed) are 1/8" less.

Adding rectangular glides increases exterior height.

Hinged doors are standard with self-closing European style hinges that open 110°. Shelves are slotted every 1 1/2" and are height adjustable in 1 1/2" increments. Shelf dividers are not included. See Accessories section.

**FP002 is not available on hinged door cabinets.**

### Accessories

See Accessories section for counterweights and accessories.

### Lock option

Wardrobes come standard with lock.

If lock is not required add suffix 'NL' after product number. Deduct \$50 list per lock.

**Nuform Wardrobes are available with an eLock option. Add \$320 to list price for eLock.**

### Finishes

Refer to Finishes section for finish options for case, Nuform Solid and Woodgrain fronts. Drawer bodies and accessories are finished in Eco Black.

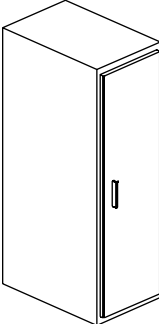
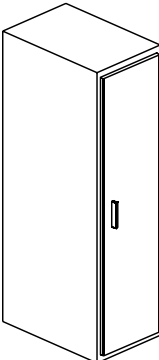
Description	Part number	Height	Width	Depth	Flat glides		Rectangular glides	Accent paint
					Coat rod + shelf/ Neutral paint	Shelves/ Neutral paint		
 <p>Nuform Wardrobe Tower to match 57" h panel eLock option available</p>	<b>VL121852Q-HD</b>	55 3/8"	12"	18"	\$1643	\$1594	+\$29	+\$166
	<b>VL122452Q-HD</b>	55 3/8"	12"	24"	\$1700	\$1594	+\$29	+\$171
	<b>VL151852Q-HD</b>	55 3/8"	15"	18"	\$1700	\$1681	+\$29	+\$171
	<b>VL152452Q-HD</b>	55 3/8"	15"	24"	\$1758	\$1681	+\$29	+\$177
	<b>VL181852Q-HD</b>	55 3/8"	18"	18"	\$1758	\$1774	+\$29	+\$177
	<b>VL182452Q-HD</b>	55 3/8"	18"	24"	\$1818	\$1643	+\$29	+\$183
	left-handed hinged door							
	<b>VR121852Q-HD</b>	55 3/8"	12"	18"	\$1643	\$1700	+\$29	+\$166
	<b>VR122452Q-HD</b>	55 3/8"	12"	24"	\$1700	\$1700	+\$29	+\$171
	<b>VR151852Q-HD</b>	55 3/8"	15"	18"	\$1700	\$1758	+\$29	+\$171
	<b>VR152452Q-HD</b>	55 3/8"	15"	24"	\$1758	\$1758	+\$29	+\$177
	<b>VR181852Q-HD</b>	55 3/8"	18"	18"	\$1758	\$1818	+\$29	+\$177
	<b>VR182452Q-HD</b>	55 3/8"	18"	24"	\$1818	\$1643	+\$29	+\$183
	right-handed hinged door (illustrated)							
 <p>Nuform Wardrobe Tower to match 64" h panel eLock option available</p>	<b>VL121860Q-HD</b>	62 7/8"	12"	18"	\$1678	\$1700	+\$29	+\$169
	<b>VL122460Q-HD</b>	62 7/8"	12"	24"	\$1774	\$1700	+\$29	+\$179
	<b>VL151860Q-HD</b>	62 7/8"	15"	18"	\$1774	\$1758	+\$29	+\$179
	<b>VL152460Q-HD</b>	62 7/8"	15"	24"	\$1825	\$1758	+\$29	+\$184
	<b>VL181860Q-HD</b>	62 7/8"	18"	18"	\$1825	\$1818	+\$29	+\$184
	<b>VL182460Q-HD</b>	62 7/8"	18"	24"	\$1874	\$1678	+\$29	+\$189
	left-handed hinged door							
	<b>VR121860Q-HD</b>	62 7/8"	12"	18"	\$1678	\$1774	+\$29	+\$169
	<b>VR122460Q-HD</b>	62 7/8"	12"	24"	\$1774	\$1774	+\$29	+\$179
	<b>VR151860Q-HD</b>	62 7/8"	15"	18"	\$1774	\$1825	+\$29	+\$179
	<b>VR152460Q-HD</b>	62 7/8"	15"	24"	\$1825	\$1825	+\$29	+\$184
	<b>VR181860Q-HD</b>	62 7/8"	18"	18"	\$1825	\$1874	+\$29	+\$184
	<b>VR182460Q-HD</b>	62 7/8"	18"	24"	\$1874	\$1678	+\$29	+\$189
	right-handed hinged door (illustrated)							



## How to order

1. Specify product number.
2. Specify case finish.
3. Specify front finish.
4. Specify options.

## Product code key example

### TL2460□-3F

- T** workplace tower  
**L** left handed door  
**24** tower width  
**60** interior height  
□ **Q** - Nuform  
**W** - veneer  
**3** number of drawers  
**F** 12" file drawer

**NOTE: Pricing for Drawer pull FP001 is standard. For additional pulls review pull option chart.**

## General information

Exterior cabinet heights are nominal. Actual heights (with glides fully recessed) are 1/8" less. Cabinets are priced inclusive of 1 pair of hangfile bars in each pullout opening. Shelves are adjustable except the shelf above the file drawers. All shelves are slotted to accept dividers. Shelf dividers are not included.

Hinged doors are standard with self-closing European style hinges that open 110°. Shelves are slotted every 1 1/2" and are height adjustable in 1 1/2" increments. Shelf dividers are not included. See Accessories section.

**FP002 is not available on hinged door cabinets.**

## Accessories

See Accessories section for counterweights and accessories.

## Lock option

Workplace towers come standard with locks.

## Finishes

Refer to Finishes section for finish options for case, Nuform Solid and Woodgrain fronts and veneer fronts. Drawer bodies and accessories are finished in Eco Black.

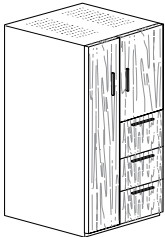
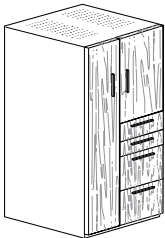
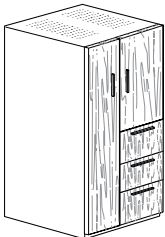
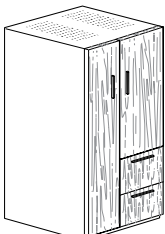
Description	Part number	Height	Width	Weight (lbs)	Nuform/ Neutral paint	Veneer/ Neutral paint	Accent paint
 <p>Tower, full length door, 24" hinged door insert and 3-12" file drawers 13 5/8" wide</p>	<b>TL2460□-3F</b>	62 7/8"	24"	185	\$3350	\$3789	+\$336
	<b>TL3060□-3F</b>	62 7/8"	30"	195	\$4020	\$4549	+\$403
	left-handed hinged door (illustrated)						
	<b>TR2460□-3F</b>	62 7/8"	24"	185	\$3350	\$3789	+\$336
 <p>Tower, full length door, 24" hinged door insert, 2-6" box and 2-12" file drawers 13 5/8" wide</p>	<b>TL2460□-2B2F</b>	62 7/8"	24"	185	\$3426	\$3873	+\$343
	<b>TL3060□-2B2F</b>	62 7/8"	30"	195	\$4111	\$4650	+\$412
	left-handed hinged door (illustrated)						
	<b>TR2460□-2B2F</b>	62 7/8"	24"	185	\$3426	\$3873	+\$343
 <p>Tower, full length door, 27" hinged door insert, 2-10.5" and 1-12" file drawers 13 5/8" wide</p>	<b>TL2460□-2F10F</b>	62 7/8"	24"	185	\$3252	\$3672	+\$326
	<b>TL3060□-2F10F</b>	62 7/8"	30"	195	\$4020	\$4549	+\$403
	left-handed hinged door (illustrated)						
	<b>TR2460□-2F10F</b>	62 7/8"	24"	185	\$3252	\$3672	+\$326
 <p>Tower, full length door, 36" hinged door insert and 2-12" file drawers 13 5/8" wide</p>	<b>TL2460□-2F</b>	62 7/8"	24"	185	\$2947	\$3317	+\$296
	<b>TL3060□-2F</b>	62 7/8"	30"	195	\$3870	\$4377	+\$389
	left-handed hinged door (illustrated)						
	<b>TR2460□-2F</b>	62 7/8"	24"	185	\$2947	\$3317	+\$296
	<b>TR3060□-2F</b>	62 7/8"	30"	195	\$3870	\$4377	+\$389
	right hand hinged door						



## Towers Workplace Towers

### How to order

1. Specify product number.
2. Specify case finish.
3. Specify front finish.
4. Specify options.

### Product code key example

**TL2460**□-2BF

**T** workplace tower  
**L** left handed door  
**24** tower width  
**60** interior height  
 □ **Q** - Nuform  
**W** - veneer

**2B** 2 6" box drawers  
**F** 12" file drawer

**NOTE: Pricing for Drawer pull FP001 is standard. For additional pulls review pull option chart.**

### General information

Exterior cabinet heights are nominal. Actual heights (with glides fully recessed) are 1/8" less. Cabinets are priced inclusive of 1 pair of hangfile bars in each pullout opening. Shelves are adjustable except the shelf above the file drawers. All shelves are slotted to accept dividers. Shelf dividers are not included.

Hinged doors are standard with self-closing European style hinges that open 110°. Shelves are slotted every 1 1/2" and are height adjustable in 1 1/2" increments. Shelf dividers are not included. See Accessories section.

**FP002 is not available on hinged door cabinets.**

### Accessories

See Accessories section for counterweights and accessories.

### Lock option

Workplace towers come standard with locks.

### Finishes

Refer to Finishes section for finish options for case, Nuform Solid and Woodgrain fronts and veneer fronts. Drawer bodies and accessories are finished in Eco Black.

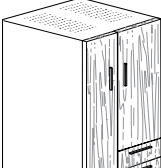
Description	Part number	Height	Width	Weight (lbs)	Nuform/ Neutral paint	Veneer/ Neutral paint	Accent paint	
	Tower, full length door, 36" hinged door insert, 2-6" box and 1-12" file drawer 13 5/8" wide	<b>TL2460</b> □-2BF	62 7/8"	24"	185	\$3252	\$3513	+\$326
		<b>TL3060</b> □-2BF	62 7/8"	30"	195	\$3961	\$4478	+\$397
		left-handed hinged door (illustrated)						
		<b>TR2460</b> □-2BF	62 7/8"	24"	185	\$3252	\$3513	+\$326
	<b>TR3060</b> □-2BF	62 7/8"	30"	195	\$3961	\$4478	+\$397	
	right hand hinged door							

### How to order

1. Specify product number.
2. Specify finish color.
3. Specify options.

### Product code key example

#### WL3060Q-6HDV

- WL** Workplace locker  
**30** tower width  
**60** interior height  
**Q** Nuform front  
**6** number of openings  
**HD** hinged doors

### General information

Exterior cabinet heights are nominal. Actual heights (with glides fully recessed) are 1/8" less. Hinged doors are standard with self closing European style hinges and open 110°.

A hinged door insert includes a bottom shelf. This means that the insert door height and usable interior space is actually 1 1/2" less than the heights noted in the descriptions.

### Lock option

**Nuform Cubbi-Stor come with eLocks only.**

### Finishes

Refer to Finishes section for finish options for case, Nuform Solid and Woodgrain fronts. Drawer bodies and accessories are finished in Eco Black.

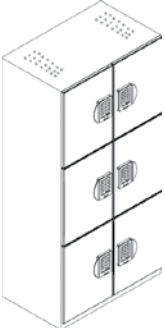
Description	Part number	Exterior Height	Width	Depth	Weight (lbs)	Neutral paint/ base price	eLock	Accent paint
 <p>Nuform Cubbi-Stor with eLock            1-18" high hinged doors and            2-19.5" high hinged door on            each side</p>	<b>WL3060Q-6HDVT</b>	62 7/8"	30"	18"	200	\$3311	+\$2209	+\$332

Description	Part number	Exterior height	Width	Depth	Weight (lbs)	Neutral paint/ base price	Accent paint
 <p>Single Nuform Cubbi-Stor, 1-18" high hinged door over 2-19" high hinged doors            Locks are included</p>	<b>VL151860Q-3HDVT</b> left-handed hinged door (illustrated)	62 7/8"	15"	18"	—	\$2739	+\$279
	<b>VR151860Q-3HDVT</b> right-handed hinged door	62 7/8"	15"	18"	—	\$2739	+\$279

Left blank intentionally.

---

# Accessories



# Accessories

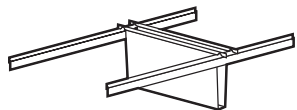

Hangfile bars

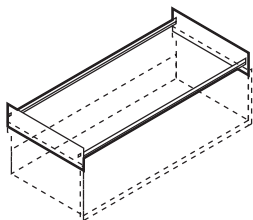

EDP Kit

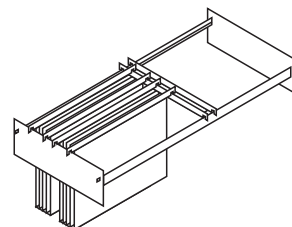

X-ray Kit

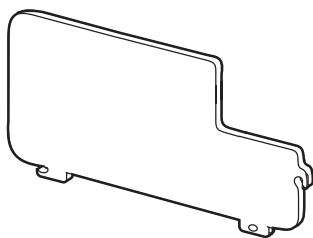
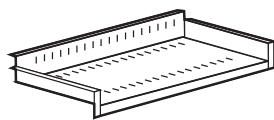
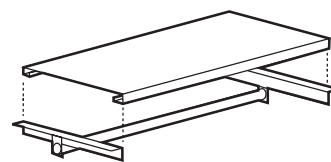

Plate divider



Fixed slotted shelf



Coat rod and blank shelf

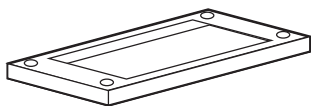

Lateral Base



Sliding Rail

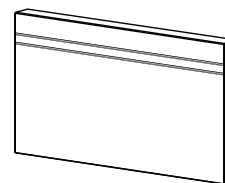

Counterweight for laterals

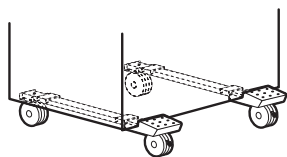

Mobile support frame

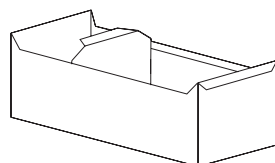

Card Tray  
"The dh Collection"

## How to order

1. Specify product number.
2. Specify finish color if necessary.

## Finishes

Accessories are finished in Eco Black.

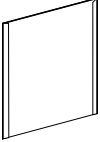
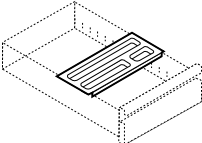
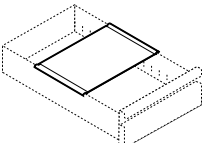
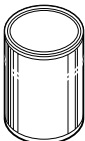
Description	Part number	Width	Depth	Weight (lbs)	List price
 <p>Counterweight, recommended for all freestanding pedestals with file and EDP drawers</p>	<b>WS-CW</b>	—	—	16	\$88
 <p>Counterweight, recommended for all mobile pedestals</p> <p>*For all non-standard Pedestals please consult our Specials Engineering Department for appropriate counterweight(s) to be used.</p>	<b>PM-CW</b>	—	—	24	\$88
 <p>Pencil tray for letter width box drawer. Black plastic.</p>	<b>WS-PT15</b>	15"	—	1	\$32
	<b>WS-PT18</b>	18"	—	1	\$33
 <p>Divider for box drawer</p>	<b>WS-DV15</b>	15"	3 ½"	—	\$18
	<b>WS-DV18</b>	18"	3 ½"	—	\$19
 <p>Set of 4 modular sloped stationery dividers, fits box drawer letter width pedestal.</p>	<b>MD-SO15</b>	15"	—	1	\$66
	<b>MD-SO18</b>	18"	—	1	\$70
 <p>Sliding reference shelf for box drawer, fits letter width pedestal only</p>	<b>WS-RS</b>	12"	—	1	\$50
 <p>Touch-up paint for standard enamel finishes. Specify finish Can contains ½ pint</p>	<b>PAINT</b>	—	—	1	\$39

# Accessories

## For pedestals

### Letter and Legal Widths

#### How to order

1. Specify product number.
2. Specify finish color if necessary.

#### Finishes

Base aprons are available in any of Inscape's standard paint finishes.

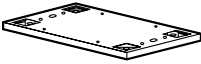
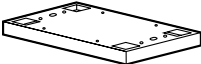
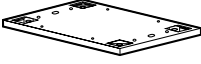
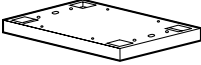
Description	Part number	Height	Width	Depth	Weight (lbs)	Neutral paint/ base price	Accent paint
 <p>7/8" base apron letter width (height does not include glide)</p>	<b>B1518-1</b>	7/8"	15"	18"	3	\$90	+\$11
	<b>B1522-1</b>	7/8"	15"	22"	4	\$90	+\$11
	<b>B1528-1</b>	7/8"	15"	28"	5	\$90	+\$11
 <p><b>2 1/8" base apron letter width (height does not include glide)</b></p>	<b>B1518-2</b>	2 1/8"	15"	18"	4	\$99	+\$12
	<b>B1522-2</b>	2 1/8"	15"	22"	5	\$99	+\$12
	<b>B1528-2</b>	2 1/8"	15"	28"	6	\$99	+\$12
 <p>7/8" base apron legal width (height does not include glide)</p>	<b>B1822-1</b>	7/8"	18"	22"	4	\$114	+\$13
	<b>B1828-1</b>	7/8"	18"	28"	5	\$114	+\$13
 <p><b>2 1/8" base apron legal width (height does not include glide)</b></p>	<b>B1822-2</b>	2 1/8"	18"	22"	6	\$123	+\$14
	<b>B1828-2</b>	2 1/8"	18"	28"	7	\$123	+\$14

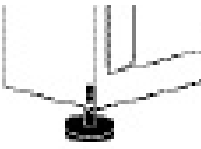
Description	Part number	Height	Width	Depth	Weight (lbs)	List price
 <p>Platform leveling glide for pedestals (set of 4). 3" diameter x 1 1/2" high plastic 'shoe'. 1 3/8" leveling adjustment.</p>	<b>PLG-P3</b> (matte black)	—	—	—	1	\$27
	<b>PLG-P3-GRY</b> (matte grey)	—	—	—	1	\$27

### How to order

1. Specify product number.
2. Specify finish color if necessary.

### General information

The accessories on these pages are used in conjunction with basic cabinets and desired drawer and shelf interiors.



### Finishes

Accessories are finished in Eco Black.

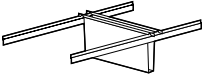
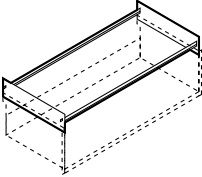
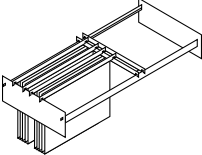
Sliding rails are available in any of Inscape's standard paint finishes..

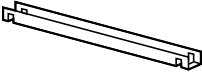
Description	Part number	Width	Weight (lbs)	List price	
	<b>Standard Paper Related Accessories</b>				
	Hangfile bars for 10.5", 12", 13.5", 15" and 16.5" pullout shelves/drawers set of 2	<b>HF-30</b>	30"	2	\$39
		<b>HF-36</b>	36"	3	\$39
		<b>HF-42</b>	42"	4	\$39
	<b>Computer Paper Related Accessories</b>				
	EDP kit for 13.5" and 15" shelves/drawers Includes Hang File Bars	<b>EDP30</b>	30"	6	\$72
		<b>EDP36</b>	36"	7	\$72
		<b>EDP42</b>	42"	8	\$72
	<b>X-Ray Related Accessories</b>				
	X-ray kit for 16.5" drawers Includes sliding rail and hang file bars	<b>XRAY/EDP30</b>	30"	2	\$80
		<b>XRAY/EDP36</b>	36"	3	\$80
		<b>XRAY/EDP42</b>	42"	3	\$80

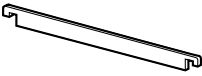
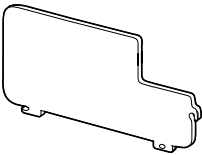
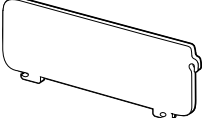
Description	Part number	Width	Weight (lbs)	Neutral paint/ base price	Accent paint
	<b>SR</b>	1 3/16"	1	\$13	+\$4

Description	Part number	Width	Weight (lbs)	List price	
	Legal to letter adapter				
		<b>LL-30</b>	30"	1	\$22
		<b>LL-36</b>	36"	2	\$22
		<b>LL-42</b>	42"	3	\$22
	<b>DVP</b>	—	1	\$18	
	<b>DVP6-9</b>	—	1	\$18	
	<b>DVP-3</b>	—	1	\$18	



# Accessories

## Interior Accessories for All Laterals

### How to order

1. Specify product number.
2. Specify finish color if necessary.

### General information

The accessories on these pages are used in conjunction with basic cabinets and desired drawer and shelf interiors.

### Finishes

Accessories are finished in Eco Black.

Slotted shelves are available in any of Inscape's standard paint finishes..

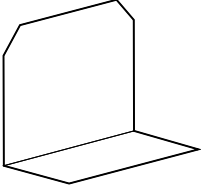
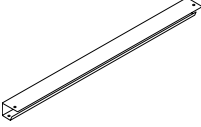
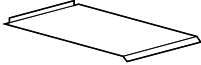
Description	Part number	Height	Width	Depth	Weight (lbs)	List price
 <p>Follower plate, includes velcro fasteners</p>	<b>FP</b>	3 1/2"	3 1/2"	2"	—	\$15
 <p>Drawer filler for 6" and 7.5" drawers only. Available for 9900 Series .</p>	<b>DF30</b> <b>DF36</b> <b>DF42</b>	— — —	30" 36" 42"	— — —	2 3 3	\$23 \$24 \$27
 <p>SuperStor™ trays Pack of 12 trays, black only</p>	<b>T12SS-BL</b>	—	10"	—	25	\$240

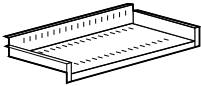
Description	Part number	Height	Width	Depth	Weight (lbs)	Neutral paint/ base price	Accent paint
 <p><b>Slotted Shelf</b> <b>Fixed slotted shelf installs behind 12", 13.5", 15" and 16.5" lift-up doors or in hinged door cabinets. Shelf is adjustable on a 1.5" increment.</b></p>	<b>SH-30</b> <b>SH-36</b> <b>SH-42</b>	— — —	30" 36" 42"	18" 18" 18"	11 12 13	\$90 \$90 \$90	+\$11 +\$11 +\$11

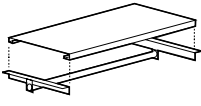
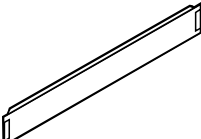
Description	Part number	Height	Width	Depth	Weight (lbs)	List price
 <p>Coat rod and blank shelf. Rod screws to underside of shelf.</p>	<b>CR30</b> <b>CR36</b> <b>CR42</b>	— — —	30" 36" 42"	16" 16" 16"	11 12 13	\$122 \$122 \$122
 <p>Raised back kit. Attaches to back of 10.5", 12", 13.5", 15" and 16.5" drawers.</p>	<b>RBKIT-30</b> <b>RBKIT-36</b> <b>RBKIT-42</b>	— — —	30" 36" 42"	— — —	2 3 3	\$22 \$23 \$24

### How to order

1. Specify product number.
2. Specify finish color if necessary.

### General information

The accessories on these pages are used in conjunction with basic cabinets and desired drawer and shelf interiors.

### Finishes

Accessories are finished in Eco Black.

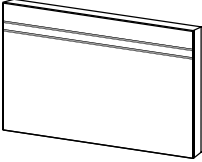
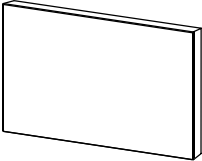
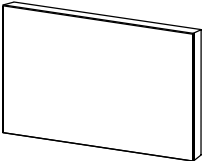
Description	Part number	Height	Width	Depth	Weight (lbs)	List price
 <p>Counterweight, recommended for all freestanding lateral file cabinets with 22.5" interior dimension or higher</p>	<b>IMCW-30</b>	—	—	—	38	\$129
	<b>IMCW-36</b>	—	—	—	38	\$129
	<b>IMCW-42</b>	—	—	—	52	\$129
 <p>Counterweight, recommended for all freestanding lateral file cabinets with less than 22.5" interior dimension</p>	<b>CW</b>	—	—	—	48	\$129
 <p>Counterweight, for non-standard lateral files when recommended by Specials Engineering Department. Secures with 2-way tape.</p>	<b>PFCW</b>	—	—	—	32	\$129

# Accessories

## Interior Accessories for All Laterals/Hinged Door Units

### How to order

1. Specify product number.
2. Specify finish color if necessary.

### General information

The accessories on these pages are used in conjunction with basic cabinets and desired drawer and shelf interiors.

### Finishes

Available in any of Inscape's standard paint finishes.

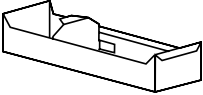
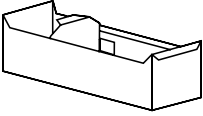
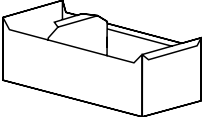
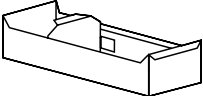
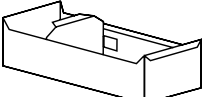
Description	Part number	Height	Width	Depth	Weight (lbs)	Neutral paint/ base price	Accent paint
 <p>Tray Accessories Tray for 3" x 5" cards or 4 1/4" x 2 3/4" cassettes. Requires 4 1/2" drawer.</p>	<b>CT53-MP</b>	2 3/4"	5 3/8"	14 7/8"	4	\$124	+\$14
 <p>Tray for 4" x 6" cards or microfiche. Requires 6" shelf/drawer.</p>	<b>CT64-MP</b>	3 3/4"	6 3/8"	14 7/8"	5	\$124	+\$14
 <p>Tray for 5" x 8" cards. Requires 6" drawer.</p>	<b>CT85-MP</b>	4 7/8"	8 3/16"	14 7/8"	6	\$124	+\$14
 <p>Tray for 3 1/4" x 7 3/8" TAB cards. Requires 6" drawer.</p>	<b>CT-TAB-MP</b>	3"	7 7/8"	14 7/8"	5	\$124	+\$14
 <p>Tray for cheques. Requires 6" drawer.</p>	<b>CT-CK-MP</b>	3 1/4"	8 1 5/16"	15 1/2"	5	\$161	+\$18

### How to order

1. Specify product number.
2. Specify finish color if necessary.





### General information

Bases are steel welded construction, flush with glides.

### Finishes

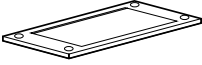
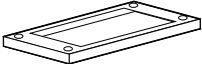
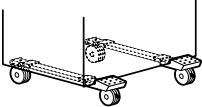
Bases are available in any of Inscape's standard or textured paint finishes. Refer to Finishes section.

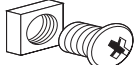
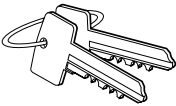
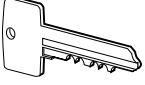
Mobile support frames come standard with black plastic bumpers and casters.

Description	Part number	Height	Width	Depth	Weight (lbs)	Neutral paint/ base price	Accent paint
 <p>Bases 7/8" (height does not include glide)</p>	<b>B3018-1</b>	7/8"	30"	18"	4	\$106	+\$12
	<b>B3618-1</b>	7/8"	36"	18"	5	\$106	+\$12
	<b>B4218-1</b>	7/8"	42"	18"	5	\$106	+\$12
 <p>2 1/8" (height does not include glide)</p>	<b>B3018-2</b>	2 1/8"	30"	18"	8	\$118	+\$14
	<b>B3618-2</b>	2 1/8"	36"	18"	9	\$118	+\$14
	<b>B4218-2</b>	2 1/8"	42"	18"	10	\$118	+\$14
Description	Part number	Height	Width	Depth	Weight (lbs)	List price	
 <p>18" mobile support frame, for 30" and 36" wide lateral files with maximum of three pullout drawers and maximum interior height of 43.5" Note: Counterweight must be installed in lateral file</p>	<b>MFK18</b>	4 5/8"	18"	4 1/2"	10	\$485	
 <p>24" mobile support frame, for 24" and 30" wide Workplace Towers with maximum of three pullout drawers and maximum height of 58 3/4" Note: Counterweight is recommended</p>	<b>MFK24</b>	4 5/8"	24"	4 1/2"	11	\$485	
 <p>Ganging Kit</p>	<b>GK</b>	—	—	—	—	\$12	
 <p>Replacement Key 1 Key Specify key number found on face of lock</p>	<b>RKEY</b>	—	—	—	—	\$10	
 <p>Extractor Key 1 Key Used to remove lock cores from file cabinets</p>	<b>EKEY</b>	—	—	—	—	\$45	
 <p>Master Key 1 Key Specify key series</p>	<b>MKEY</b>	—	—	—	—	\$45	

# Accessories

## For all laterals

### How to order

1. Specify product number.
2. Specify finish color if necessary.



### General information

The accessories on these pages are used in conjunction with basic cabinets and desired drawer and shelf interiors.

### Finishes

Lock Core is available in three finishes: black, satin chrome and bright chrome.

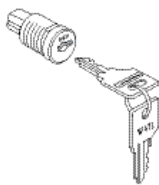
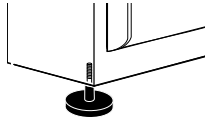
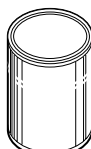
Touch up paint is available in any of our standard paint colors.

Description	Part number	Height	Width	Depth	Weight (lbs)	List price
 <p>Comes with core and two keys</p>	<b>LAT-SB-CORE</b>	—	—	—	—	\$24
 <p>Platform leveling glide for lateral files (set of 4). 3 1/2" diameter x 1 1/2" high plastic 'shoe'. 1 3/8" leveling adjustment</p>	<b>PLG-L3</b> (matte black)	1 1/2"	3 1/2"	—	1	\$27
	<b>PLG-L3-GRY</b> (matte grey)	1 1/2"	3 1/2"	—	1	\$27
 <p>Touch-up paint for standard enamel finishes. Specify finish Can contains 1/2 pint</p>	<b>PAINT</b>	—	—	—	1	\$39
 <p>Label Holder for 9900</p>	<b>LBLHLDR-99LN</b>	—	—	—	—	\$5

### How to order

1. Specify product number.
2. Specify finish.



### General information

Optional plastic laminate tops are self-edged, high pressure laminate with backing sheet, over a core of high density particle board.

### Finishes

Tops are available in any standard Office Specialty laminate. Refer to Finishes section.

Note that plywood edge is not an option on these tops as they are self-edged.

Description	Part number	Thickness	Width	Depth	Weight (lbs)	Laminate/base price	Grade 1 laminate
 Plastic Laminate Tops	<b>PL-30</b>	1 1/16"	30"	18"	15	\$235	+\$76
	<b>PL-36</b>	1 1/16"	36"	18"	20	\$269	+\$87
	<b>PL-42</b>	1 1/16"	42"	18"	25	\$282	+\$91
	<b>PL-60</b>	1 1/16"	60"	18"	30	\$400	+\$129
	<b>PL-72</b>	1 1/16"	72"	18"	40	\$480	+\$155
	<b>PL-84</b>	1 1/16"	84"	18"	50	\$558	+\$180
 Plastic Laminate Tops	<b>PL-3630</b>	1 1/16"	30"	36"	35	\$455	+\$147
	<b>PL-3636</b>	1 1/16"	36"	36"	42	\$502	+\$161
	<b>PL-3642</b>	1 1/16"	42"	36"	49	\$524	+\$168
	<b>PL-3660</b>	1 1/16"	60"	36"	69	\$750	+\$240
	<b>PL-3666</b>	1 1/16"	66"	36"	76	\$801	+\$257
	<b>PL-3672</b>	1 1/16"	72"	36"	83	\$900	+\$289
	<b>PL-3684</b>	1 1/16"	84"	36"	97	\$1097	+\$352

# Accessories

## Lateral Tops

Nuform

### How to order

1. Specify product number.
2. Specify finish color.
3. Specify options.

### Product code key example

**N**□**1930**



- N** Nuform top  
 **W** - Woodgrain  
**S** - Solid  
**19** depth  
**30** width

### General information

Nuform Tops are available in single and double depths. **Note: Top will overhang lateral ½" front and back. If single-depth lateral is positioned flush against a wall, there will be a 1" overhang at the front.**

### Finishes

Available in solid and woodgrain finishes. Refer to Finishes section.

Description	Part number	Thickness	Width	Depth	Weight (lbs)	List price	Woodgrain
 Nuform Tops	<b>N 1930</b>	1 ¼"	30"	19"	18	\$235	\$264
	<b>N 1936</b>	1 ¼"	36"	19"	21	\$269	\$304
	<b>N 1942</b>	1 ¼"	42"	19"	25	\$282	\$316
	<b>N 1960</b>	1 ¼"	60"	19"	36	\$400	\$453
	<b>N 1966</b>	1 ¼"	66"	19"	39	\$442	\$495
	<b>N 1972</b>	1 ¼"	72"	19"	43	\$480	\$540
	<b>N 1978</b>	1 ¼"	78"	19"	46	\$520	\$583
	<b>N 1984</b>	1 ¼"	84"	19"	50	\$558	\$625
	<b>N 1990</b>	1 ¼"	90"	19"	53	\$597	\$669
	<b>N 1996</b>	1 ¼"	96"	19"	57	\$635	\$711
 Nuform Tops	<b>N 3730</b>	1 ¼"	30"	37"	35	\$455	\$508
	<b>N 3736</b>	1 ¼"	36"	37"	42	\$502	\$564
	<b>N 3742</b>	1 ¼"	42"	37"	49	\$524	\$592
	<b>N 3760</b>	1 ¼"	60"	37"	69	\$750	\$843
	<b>N 3766</b>	1 ¼"	66"	37"	76	\$801	\$899
	<b>N 3772</b>	1 ¼"	72"	37"	83	\$900	\$1011
	<b>N 3778</b>	1 ¼"	78"	37"	90	\$999	\$1123
	<b>N 3784</b>	1 ¼"	84"	37"	97	\$1097	\$1231
	<b>N 3790</b>	1 ¼"	90"	37"	104	\$1196	\$1344
	<b>N 3796</b>	1 ¼"	96"	37"	111	\$1294	\$1451

### How to order

1. Specify product number.
2. Specify finish.

### General information

Tops are sized to suit any combination of one, two or three laterals and include 3/16" overhang on each side. **Tops cannot be combined together.**

### Finishes

Available in both conventional and composite veneers. Refer to the Finishes section of this price list.

Description	Part number	Thickness	Width	Depth	Weight (lbs)	List price
 Veneer Tops	<b>VT-30</b>	1 1/4"	30"	19"	18	\$804
	<b>VT-36</b>	1 1/4"	36"	19"	21	\$830
	<b>VT-42</b>	1 1/4"	42"	19"	25	\$858
	<b>VT-60</b>	1 1/4"	60"	19"	36	\$885
	<b>VT-72</b>	1 1/4"	72"	19"	43	\$941



# Accessories

## Lateral Cushions

### How to order





1. Specify product number.
2. Specify upholstery name and number.

### General information

Cushion topper is a slimline 1 ¼" thick, 5-pce construction. All seams feature double row top stitching seen in fine upholstered pieces. The result provides crisp rectilinear styling. Interior is CAL 117 fire-retardant polyurethane foam with a 2.2 lb/ft density. This upholstered cushion is balanced with a 7/16" board and attaches to cabinet top with heavy duty Velcro.







### Upholstery

Select from our graded upholstery program of solid color fabrics and vinyls or choose COM option (Customers Own Material). To determine if a COM fabric has been pre-approved for use on our cushion topper, contact your Client Services Representative or go to [myinscape.com](http://myinscape.com). Refer to page 15 for additional layout and COM details. Due to the nature of the design and manufacture of our cushion, only approved fabrics will be accepted for application. For a description of the procedure required for COM fabric approval see sample 'Cushion COM Test Request' form found in the General Information section of this price list. This form can be downloaded from [Insite](#) or by contacting your Client Services Representative for assistance.

Description	Part number	Thickness	Width	Weight (lbs)	Grade A	Grade B	Grade C	Grade D	Grade E	Grade F
 18" d lateral cushion (standard application)	LATCUSH1830SL	1 ¼"	30"	7	\$381	+\$74	+\$147	+\$178	+\$221	+\$326
	LATCUSH1836SL	1 ¼"	36"	8	\$414	+\$86	+\$171	+\$208	+\$257	+\$381
	LATCUSH1842SL	1 ¼"	42"	10	\$449	+\$98	+\$192	+\$239	+\$295	+\$435
	LATCUSH1860SL	1 ¼"	60"	14	\$543	+\$134	+\$266	+\$328	+\$404	+\$596
	LATCUSH1866SL	1 ¼"	66"	15	\$591	+\$158	+\$293	+\$361	+\$444	+\$654
	LATCUSH1872SL	1 ¼"	72"	15	\$640	+\$160	+\$317	+\$391	+\$479	+\$707
	LATCUSH1878SL	1 ¼"	78"	17	\$701	+\$186	+\$366	+\$453	+\$556	+\$816
	LATCUSH1884SL	1 ¼"	84"	24	\$747	+\$212	+\$392	+\$524	+\$632	+\$902
 19 ¾" Lateral Cushion (Benching application with electrical)	LATCUSH19830SL	1 ¼"	30"	7	\$390	+\$74	+\$146	+\$178	+\$220	+\$325
	LATCUSH19836SL	1 ¼"	36"	8	\$427	+\$85	+\$170	+\$206	+\$256	+\$380
	LATCUSH19842SL	1 ¼"	42"	10	\$463	+\$97	+\$194	+\$238	+\$294	+\$534
	LATCUSH19860SL	1 ¼"	60"	14	\$575	+\$134	+\$267	+\$329	+\$405	+\$597
	LATCUSH19866SL	1 ¼"	66"	15	\$612	+\$148	+\$292	+\$359	+\$443	+\$651
	LATCUSH19872SL	1 ¼"	72"	15	\$648	+\$160	+\$316	+\$390	+\$479	+\$706
	LATCUSH19878SL	1 ¼"	78"	17	\$686	+\$173	+\$340	+\$419	+\$517	+\$760
	LATCUSH19884SL	1 ¼"	84"	24	\$724	+\$185	+\$365	+\$451	+\$554	+\$814
 21 ½" Lateral Cushion (Private Office application with electrical)	LATCUSH21530SL	1 ¼"	30"	7	\$390	+\$79	+\$152	+\$183	+\$225	+\$330
	LATCUSH21536SL	1 ¼"	36"	8	\$433	+\$85	+\$170	+\$206	+\$256	+\$380
	LATCUSH21542SL	1 ¼"	42"	11	\$465	+\$97	+\$194	+\$237	+\$294	+\$434
	LATCUSH21560SL	1 ¼"	60"	15	\$592	+\$134	+\$266	+\$328	+\$404	+\$596
	LATCUSH21566SL	1 ¼"	66"	16	\$630	+\$147	+\$292	+\$358	+\$441	+\$650
	LATCUSH21572SL	1 ¼"	72"	17	\$669	+\$159	+\$316	+\$389	+\$477	+\$705
	LATCUSH21578SL	1 ¼"	78"	18	\$681	+\$173	+\$343	+\$491	+\$591	+\$843
	LATCUSH21584SL	1 ¼"	84"	25	\$712	+\$212	+\$392	+\$524	+\$632	+\$902
 36" d lateral cushion (back-to-back application)	LATCUSH3630SL	1 ¼"	30"	14	\$470	+\$70	+\$144	+\$171	+\$214	+\$319
	LATCUSH3636SL	1 ¼"	36"	19	\$518	+\$82	+\$167	+\$200	+\$250	+\$372
	LATCUSH3642SL	1 ¼"	42"	19	\$546	+\$94	+\$191	+\$232	+\$288	+\$427
 39 ½" - Lateral Cushion (Back-to-back benching application with electrical)	LATCUSH39530SL	1 ¼"	30"	14	\$477	+\$70	+\$143	+\$170	+\$213	+\$318
	LATCUSH39536SL	1 ¼"	36"	15	\$521	+\$82	+\$190	+\$225	+\$274	+\$400
	LATCUSH39542SL	1 ¼"	42"	16	\$593	+\$94	+\$204	+\$239	+\$286	+\$426

### How to order

1. Specify product number.





Description	Part number	List price
 <p>Standard Flat Pedestal Glides Set of 4</p>	<b>LV001</b>	\$26
 <p>Extended Flat Pedestal Glides Set of 4</p>	<b>LV002</b>	\$26
 <p>Standard Flat Lateral Glides Set of 4</p>	<b>LV003</b>	\$26
 <p>Extended Flat Lateral Glides Set of 4 (previously LG)</p>	<b>LV004</b>	\$26
 <p>2" dia. Round Bookcase Glides, Black Set of 4</p>	<b>LV009</b>	\$26
 <p>2" dia. Round Bookcase Glides, Grey Set of 4</p>	<b>LV010</b>	\$27

# Accessories

## Glides

How to order

1. Specify product number.

Description	Part number	List price
 <p>2" dia. Round Pedestal and Lateral Glides, Black Set of 4</p>	<b>LV011</b>	\$24
 <p>2" dia. Round Pedestal and Lateral Glides, Grey Set of 4</p>	<b>LV012</b>	\$24
 <p>2" dia. Round Storwal Lateral Glides, Black Set of 4</p>	<b>LV013</b>	\$24
 <p>2" dia. Round Storwal Lateral Glides, Grey Set of 4</p>	<b>LV014</b>	\$24
 <p>2" dia. Round Storwal Bookcase Glides, Black Set of 4</p>	<b>LV015</b>	\$26
 <p>2" dia. Round Storwal Bookcase Glides, Grey Set of 4</p>	<b>LV016</b>	\$26

### How to order

1. Specify product number.

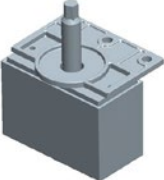
Description	Part number	List price
 <p data-bbox="375 464 688 516">Rectangular Lateral Glides, Grey Set of 4</p>	<b>LV018</b>	\$40
 <p data-bbox="375 701 708 753">Rectangular Pedestal Glides, Grey Set of 4</p>	<b>LV019</b>	\$40

# Accessories

## Modular Towers

### How to order

1. Specify product number.

### Specification Guidelines

- A maximum of 6 CD compartments may be positioned inside MoPed, 3 on the top rail and 3 on the lower rail. Note: If CD compartments are positioned on top rail, top two slots in compartments are not accessible.
- Compartments and support brackets hook onto any one of three rails inside the drawer.
- Compartments may also be placed on lower level of drawer. 3 ¾" wide compartment may be placed into upper level of drawer.
- Although pencil tray is designed for use in upper compartment it will fit on lower level of drawer.

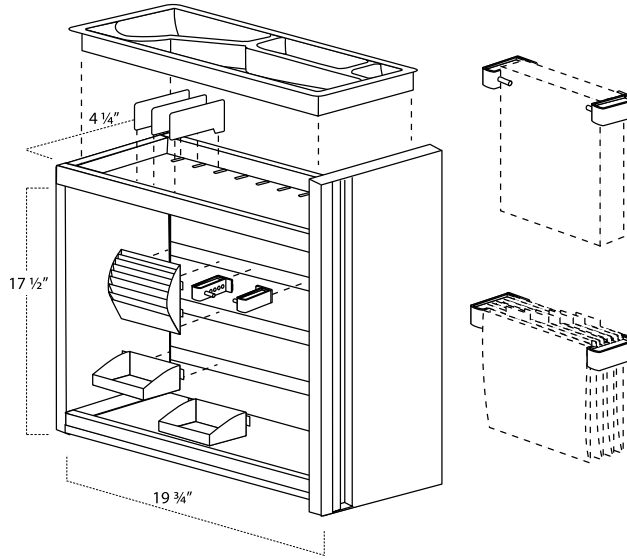

### Support Brackets

Adjustable posts on support brackets may be specified to hold objects from 1/16" to 3/4" thick in place.

or

Support brackets may be specified to suspend hanging files. Adjustable posts may be removed if brackets are specified for this application.

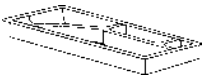
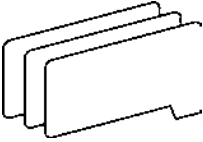
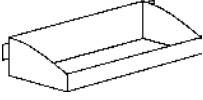
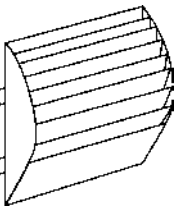
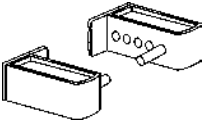
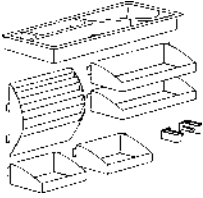
Description	Part number	Height	Width	Depth	Weight (lbs)	List price
 <b>Pencil Tray</b> Plastic - silver	<b>OS-PFM-PT19</b>	1"	4 ¼"	19 ½"	—	\$25
 <b>Dividers</b> Up to 9" dividers will fit in upper compartment. Pkg. of 3 Plastic - transparent	<b>OS-PFM-DVP</b>	1"	4 ¼"	—	1	\$20
 <b>Storage Compartments</b> Plastic - transparent	<b>OS-SC4334</b> <b>OS-SC4534</b> <b>OS-SC4734</b> <b>OS-SC41134</b>	1 ½" 1 ½" 1 ½" 1 ½"	3 ¾" 5 ¾" 7 ¾" 11 ¾"	4" 4" 4" 4"	— — — —	\$22 \$24 \$25 \$27
 <b>CD Compartment</b> Holds 8 CD's Plastic - Transparent	<b>OS-CDC</b>	7"	5"	—	—	\$29
 <b>Support Brackets</b> Includes 1 right-handed and 1 left-handed bracket each with removable post. Plastic - Transparent Post - Aluminum	<b>OS-SBKT</b>	2"	1 ¼"	3 ¾"	—	\$49
 <b>Starter Package</b> includes: 1 x pencil tray 1 x CD tray 2 x 5 ¾" compartments 2 x 3 ¾" compartments 1 x support brackets	<b>OS-SPKG</b>	—	—	—	1	\$167

### How to order

1. Specify product number.

### General information

**Whiteboards** have raised edges at each end and include a separate 10 ½" wide marker tray. Whiteboards and marker trays are manufactured from steel and mount magnetically. Marker tray and side trim on whiteboards are field installed.

**Modular Towers Mobile Kit** comes with two locking swivel casters, two non-locking swivel casters and a counterweight. Mobile Kit can only be mounted on Office Specialty Modular Storage Towers with an exterior case height of 46 ½" or higher and having a pedestal drawer configuration that does not exceed 30" interior dimensional opening.

**Note: The mobile kit adds 3 ½" to the height.**

### Finishes

Whiteboards are powder coated in white paint specially formulated for dry erase markers. Marker tray and raised edges on whiteboard are finished in black.

**Note: Whiteboards are not intended for use with PERMANENT markers. Only Expo Markers are to be used on any Office Specialty Whiteboard. Whiteboards should be cleaned with Expo Eraser or a Microfiber cleaning cloth along with Expo Cleaning Solution which is formulated to remove residue from Expo Dry Erase Markers.**

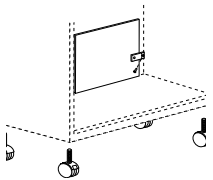
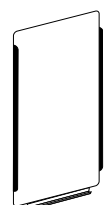
Description	Part number	Height	Width	Depth	Weight (lbs)	List price
 <p>Mobile Kit can only be mounted on towers with an exterior case height of 46.5" or higher and having a pedestal drawer configuration that does not exceed 30". Note: The mobile kit adds 3.25" to the height of the tower.</p>	<b>MTMK</b>	3 ¼"	—	—	22	\$156
 <p>Magnetic Whiteboards for side-access towers. Includes marker tray.</p>	<b>MWB13165</b>	16 ½"	13 ¾"	—	10	\$247
	<b>MWB1318</b>	18"	13 ¾"	—	13	\$253
	<b>MWB13195</b>	19 ½"	13 ¾"	—	14	\$261
	<b>MWB13315</b>	31 ½"	13 ¾"	—	16	\$269
	<b>MWB1333</b>	33"	13 ¾"	—	18	\$278

# Accessories

## Verticals

### How to order

1. Specify product number.
2. Specify finish color if necessary.



### General information

Bases are steel welded construction, flush with glides.

### Finishes

Bases are available in any standard or textured finish. Refer to Finishes section.

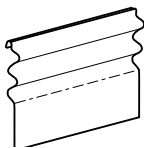
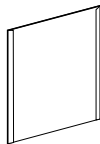
All interior accessories are finished in Eco Black.

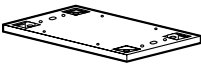
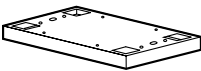
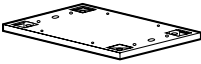
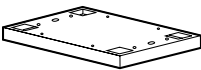
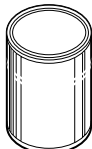
Description	Part number	Height	Width	Depth	Weight (lbs)	List price
 Vertical Compressor	<b>CP15</b> Letter width	—	15"	—	3	\$17
	<b>CP18</b> Legal width	—	18"	—	3	\$17
 Counterweight, recommended for all freestanding pedestals with file and EDP drawers	<b>WS-CW</b>	—	—	—	16	\$88
 Counterweight for use in Waste/Recycle Bin Vertical Files	<b>PFCW3</b>	—	—	16	16	\$129
 7/8" base apron letter width (height does not include glide)	<b>B1528-1</b>	7/8"	15"	28"	5	\$90
 2 1/8" base apron letter width (height does not include glide)	<b>B1528-2</b>	2 1/8"	15"	28"	6	\$99
 7/8" base apron legal width (height does not include glide)	<b>B1828-1</b>	7/8"	18"	28"	5	\$114
 2 1/8" base apron legal width (height does not include glide)	<b>B1828-2</b>	2 1/8"	18"	28"	7	\$123
 Touch-up paint for standard enamel finishes. Specify finish. Can contains 1/2 pint	<b>PAINT</b>	—	—	—	1	\$39

### General information

- Included in kit: 20-port USB 2.0 charger, twenty 6-Foot USB 2.0 cables, power cord, mounting bracket, instruction sheet, carrying case
- Charges up to 20 ports at one time
- Kit includes the standard kit in a carry case plus 1 5' Micro-B connector
- LED indicator lights show which USB ports are in use at any given time
- Security Module: Over-current, Over-voltage, Short circuit protection, CE, FCC, ROHS approval
- Power adapter with 20V/4.5

Description	Part number	List price
 <p data-bbox="375 848 589 898">eLock Multi-USB Port Charger Kit</p>	<b>ELCHRG-MP20</b>	<b>\$1189</b>



**inscape**

67 Toll Road  
Holland Landing, Ontario  
L9N 1H2 Canada

T 905 836 7676  
F 905 836 6000

[myinscape.com](http://myinscape.com)

© Inscape Corporation 2016™

® trademarks of Inscape Corporation. Patents may be pending. Certain names, words, logos and graphics or designs contained herein are trademarks or service marks of Inscape Corporation.